

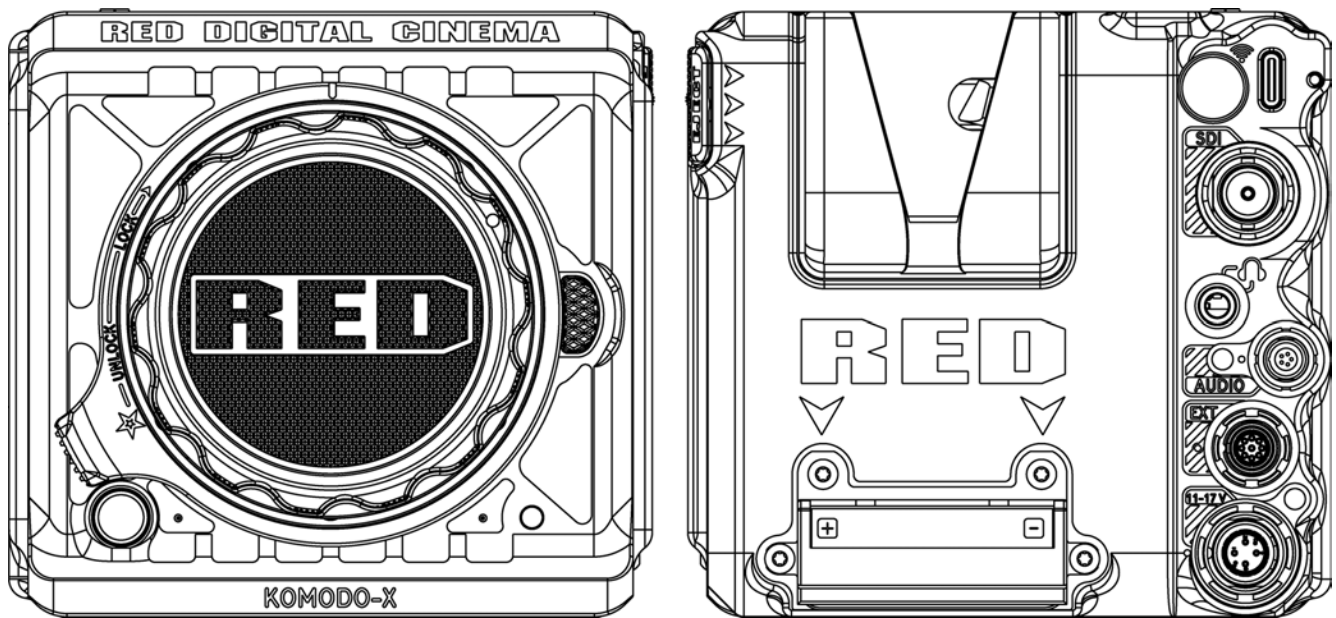

KOMODO-X™ OPERATION GUIDE



KOMODO-X 6K S35 | V1.0

RED.COM

TABLE OF CONTENTS

DISCLAIMER	IV	PRE-RECORD	71
SAFETY INSTRUCTIONS	VI	RECORDING MODE	73
1. INTRODUCTION		TIMELAPSE	74
RED KOMODO-X™	1	FRAME LIMIT	75
2. QUICK REFERENCE		SLATE	76
PREPARING THE CAMERA HARDWARE	4	AUDIO / TC MENU	81
PREPARING THE CAMERA SYSTEM	4	AUDIO SOURCE	83
RECORDING	4	INTERNAL MICROPHONE	84
PROCESSING FOOTAGE	4	EXTERNAL AUDIO	85
3. CAMERA COMPONENTS		HEADPHONE	86
CAMERA BODY	5	TIMECODE SOURCE	87
CAMERA BODY CONTROLS AND FEATURES	5	TIMECODE DISPLAY MODE	89
FRONT	5	MONITORING MENU	90
TOP	6	ONBOARD LCD	91
LEFT	7	TOP LCD	94
RIGHT	8	SDI	97
BACK	9	LIVE STREAM	108
BOTTOM	10	TOOLS	109
CAMERA BODY LEDS	11	GUIDES	117
LENSES AND ADAPTERS	15	MEDIA MENU	125
COMPATIBLE LENSES	16	EJECT	125
COMPATIBLE MOUNT ADAPTERS	16	MEDIA INFO	126
ATTACHING LENSES	16	SECURE FORMAT	126
REMOVING LENSES	16	USER SETTINGS MENU	130
ONBOARD LCD TOUCHSCREEN	17	PRESETS	130
STATUS BAR	21	USER BUTTONS	133
STATUS PAGE	25	AUTOFOCUS MENU	137
MONITORING TOOLS	26	ENABLE	137
HISTOGRAM	30	MODE	138
AUDIO TOOLS	31	SIZE	138
PLAYBACK	33	POSITION	138
4. MENUS		AF TOGGLE	139
IMAGE / LUT MENU	38	COMMUNICATION MENU	140
ISO	39	CAMERA	140
SHUTTER	40	CONNECTIONS	141
WHITE BALANCE	42	CLIENTS & SERVICES	156
ND	45	CLOUD UPLOAD	159
OUTPUT COLOR SPACE	46	SYSTEM SETTINGS MENU	164
OUTPUT TONE MAP	46	DATE / TIME	165
HIGHLIGHT ROLL-OFF	47	LICENSES	167
DISPLAY PRESET	48	LENS	168
3D LUT	49	POWER	170
CDL	51	SENSOR	171
FILM GRADE AND VIDEO GRADE	52	INDICATORS	172
EXPOSURE ADJUST	57	GPO FUNCTION	174
PROJECT SETTINGS MENU	58	STATUS SETTINGS	175
FORMAT	59	SYSTEM STATUS	179
RECORDING FRAME RATE	63	LANGUAGE MENU	181
PROJECT TIME BASE	65	MAINTENANCE MENU	181
FILE FORMAT	65	CALIBRATE	182
R3D QUALITY	68	CALIBRATION	183
PRORES RESOLUTION	69	SAVE LOG	184
PRORES CODEC	70	RESET DEFAULTS	185
PRORES COLOR PROFILE	70	FACTORY RESET	185
		UPGRADE	186

5. HOW TO

WI-FI CONFIGURATION	187
CONNECTING WIRELESSLY TO AN EXISTING WI-FI NETWORK	187
FTPS CONFIGURATION	190
CAMERA SET-UP	191
SOFTWARE SET-UP (FILEZILLA)	192
ADDITIONAL INFORMATION	193
USB-C CONFIGURATION	194
USB-C APPLE CONFIGURATION	195
USB-C ANDROID CONFIGURATION	202
USB-C ETHERNET CONFIGURATION	208
POWER	211
ATTACHING THE BATTERY	211
REMOVING THE BATTERY	211
POWER COMPONENTS	211
AUTO BOOT ON POWER	211
POWER CONSUMPTION	212
POWER PRIORITY	212
TURNING ON THE CAMERA	212
TURNING OFF THE CAMERA	213
MEDIA MANAGEMENT	213
EJECTING (UNMOUNTING) MEDIA	213
INSERTING THE MEDIA	215
SECURE FORMAT	217
MEDIA INFORMATION	218
FILE SYSTEM	219
CLIP NAMING CONVENTION	219
CLIP METADATA	219
MEDIA BEST PRACTICES	220
RED MONITOR INTERFACE CABLE	221
MONITORING	222
ONBOARD LCD TOUCHSCREEN	222
SDI OUTPUT TO A MONITOR	223
RED CONTROL	225
EXPOSURE	227
FALSE COLOR EXPOSURE TOOLS	228
FOCUS	229
FOCUS PEAKING MODE	229
EDGE PEAKING MODE	229
PEAKING PEAKING MODE	229
TIMECODE	230
TIME OF DAY	230
EDGE CODE	231
ZEBRA MODES	233
ZEBRA OVERVIEW	233
PRE-RECORDING CONTENT	234
CALIBRATING THE SENSOR	235
WHEN TO CALIBRATE THE SENSOR	235
UPGRADING THE FIRMWARE	235
VERIFYING THE FIRMWARE VERSION	235
UPGRADING THE FIRMWARE	235
UPGRADING THE DSMC3 [™] RED [®] TOUCH 7.0" LCD FIRMWARE	238
UPDATING AUTOMATICALLY THROUGH THE CAMERA	238
UPDATING MANUALLY THROUGH SMALLHD	238
SYSTEM MAINTENANCE	239
EXTERIOR SURFACES	239

STORAGE	239
ONBOARD LCD SCREEN	240
WATER DAMAGE	240

6. TROUBLESHOOTING

GENERAL TROUBLESHOOTING TIPS	241
CONTACT SUPPORT	241
STATUS ICONS	242

A. MECHANICAL DRAWINGS

FRONT VIEW	244
BACK VIEW	245
RIGHT SIDE VIEW	246
LEFT SIDE VIEW	247
TOP VIEW	248
BOTTOM VIEW	249
FEMALE RP SMA PORT	250
USB TYPE-C PORT	251
12G-SDI	252
HEADPHONE JACK	254
AUDIO PORT	255
EXTENSION PORT	256
6-PIN DC-IN	257

B. MENU MAP

C. TECHNICAL SPECIFICATIONS

D. ACCESSORIES

REDOVOLT [®] NANO-V BATTERY	263
REDOVOLT [®] MICRO-V BATTERY	264
RED [®] COMPACT DUAL V-LOCK CHARGER	265
CFEXPRESS TYPE B MEDIA	266
RED [®] CFEXPRESS TYPE B READER	267
KOMODO-X [™] RF TO PL ADAPTER PACK	268
KOMODO-X [™] RF TO PL WITH ELECTRONIC ND ADAPTER PACK	269
DSMC3 [™] RED [®] TOUCH 7.0" LCD	270
DSMC3 [™] RED [®] TOUCH 7.0" LCD HOOD	271
KOMODO-X [™] POWER ADAPTOR	272
OUTRIGGER HANDLE	272
RED [®] COMPACT TOP HANDLE	273
KOMODO [®] WING GRIP	274
DSMC3 [™] RED [®] 5-PIN TO SINGLE 3.5 MM ADAPTER	274
DSMC3 [™] RED [®] 5-PIN TO DUAL XLR ADAPTER	274
RED [®] PRO I/O MODULE	275
RED CONTROL APPS	276
RED CONTROL	276
RED CONTROL PRO	277
RED CONNECT	277

DISCLAIMER

RED[®] has made every effort to provide clear and accurate information in this document, which is provided solely for the user's information. While thought to be accurate, the information in this document is provided strictly "as is" and RED will not be held responsible for issues arising from typographical errors or user's interpretation of the language used herein that is different from that intended by RED. All information is subject to change as a result of changes in local, federal or other applicable laws.

RED reserves the right to revise this document and make changes from time to time in the content hereof without obligation to notify any person of such revisions or changes. In no event shall RED, its employees or authorized agents be liable to you for any damages or losses, direct or indirect, arising from the use of any technical or operational information contained in this document.

This document was generated on 9/1/2023. To see earlier versions of this document, submit a Support ticket at <https://support.red.com>. For comments or questions about content in this document, send a detailed email to OpsGuides@red.com.

COPYRIGHT NOTICE

COPYRIGHT© 2023 RED.COM, LLC

All trademarks, trade names, logos, icons, images, written material, code, and product names used in association with the accompanying products are the copyrights, trademarks, or other intellectual property owned and controlled exclusively by RED.COM, LLC. For a comprehensive list, see www.red.com/trademarks.

TRADEMARK DISCLAIMER

All other company, brand, and product names are trademarks or registered trademarks of their respective holders. RED has no affiliation to, is not associated with or sponsored by, and has no express rights in third-party trademarks. Adobe and Adobe Premiere Pro are registered trademarks of Adobe Systems Incorporated. DaVinci and DaVinci Resolve are registered trademarks of Blackmagic Design in the U.S. and other countries. Leica is a registered trademark of Leica Microsystems. Canon is a registered trademark of Canon, U.S.A. Apple, iOS, Macintosh, Final Cut Pro, and QuickTime are registered trademarks of Apple Inc. in the U.S. and other countries. Windex is a registered trademark of S. C. Johnson & Son, Inc. Windows is a registered trademark of Microsoft Corporation. Avid is a registered trademark of Avid Technology, Inc. FileZilla is a registered trademark of its respective owners. Nuke™ is a trademark of The Foundry Visionmongers Ltd. SCRATCH is a registered trademark ® of ASSIMILATE, 2006. SCRATCH SCAFFOLDS, SCRATCH EXTENSIONS, and SCRATCH Digital Intermediate Process Solution are all trademarks and registered trademarks of ASSIMILATE, 2006, All rights reserved. Autodesk, the Autodesk logo, Flame are registered trademarks or trademarks of Autodesk, Inc., and/or its subsidiaries and/or affiliates in the USA and/or other countries.

COMPLIANCE STATEMENTS

INDUSTRIAL CANADA EMISSION COMPLIANCE STATEMENTS

This device complies with Industry Canada license-exempt RSS standards RSS 139 and RSS 210. Operation is subject to the following two conditions: (1) this device may not cause interference, and (2) this device must accept any interference, including interference that may cause undesired operation of the device.

This Class B digital apparatus complies with Canadian ICES-003.

To comply with FCC and Industry Canada RF exposure limits for general population/ uncontrolled exposure, the antenna(s) used for this transmitter must be installed to provide a separation distance of 70 mm from all persons and operating in conjunction with any other antenna or

transmitter, except in accordance with FCC multi-transmitter product procedures.

Other user manual statements may apply.

Le présent appareil est conforme aux CNR d'Industrie Canada applicables aux appareils radio exempts de licence. L'exploitation est autorisée aux deux conditions suivantes : (1) l'appareil ne doit pas produire de brouillage, et (2) l'utilisateur de l'appareil doit accepter tout brouillage radioélectrique subi, même si le brouillage est susceptible d'en compromettre le fonctionnement.

Cet appareil numérique de la classe B est conforme à la norme NMB-003 du Canada.

Pour se conformer aux limites d'exposition aux RF de la FCC et d'industries Canada pour la population générale/ exposition non contrôlée, l'antenne(s) utilisée pour ce transmetteur doit être installée pour fournir une distance de séparation d'au moins 70 mm de toutes les personnes et fonctionnant conjointement avec une autre antenne ou émetteur, sauf en conformité avec les procédures de produits multi-émetteur FCC.

Autres d'éclairations manuel de l'utilisateur peuvent s'appliquer.

FEDERAL COMMUNICATIONS COMMISSION (FCC) STATEMENTS



This equipment has been tested and found to comply with the limits for a Class A digital device, pursuant to part 15 of the FCC Rules. These limits are designed to provide reasonable protection against harmful interference when the equipment is operated in a commercial

environment. This equipment generates, uses, and can radiate radio frequency energy and, if not installed and used in accordance with the instruction manual, may cause harmful interference to radio communications. Operation of this equipment in a residential area is likely to cause harmful interference in which case the user will be required to correct the interference at his own expense.

To maintain compliance with FCC regulations, shielded cables must be used with this equipment. Operation with non-approved equipment or unshielded cables is likely to result in interference to radio and TV reception. The user is cautioned that changes and modifications made to the equipment without the approval of manufacturer could void the user's authority to operate this equipment.

This device complies with Part 15 of the FCC Rules.

Operation is subject to the following two conditions (1) this device may not cause harmful interference, and (2) this device must accept any interference received, including interference that may cause undesired operation.



CAUTION: Exposure to Radio Frequency Radiation.

The device shall be used in such a manner that the potential for human contact is minimized.

This equipment complies with FCC radiation exposure limits set forth for an uncontrolled environment. This equipment should be installed and operated with a minimum distance of 20 cm between the radiator and your body.



CAUTION: Regulations of the FCC and FAA prohibit airborne operation of radio-frequency wireless devices because their signals could interfere with critical aircraft instruments.



CAUTION: If the device is changed or modified without permission from RED, the user may void his or her authority to operate the equipment.

AUSTRALIA AND NEW ZEALAND STATEMENTS

RED declares that the radio equipment described in this document complies with the following international standards:

- IEC 62368-1 – Product Safety
 - ETSI EN 300 328 – Technical requirement for radio equipment
- RED declares digital devices described in this document comply with the following Australian and New Zealand standards:
- AS/NZS CISPR 32 – Electromagnetic Interference
 - AS/NZS 61000.3.2 – Power Line Harmonics
 - AS/NZS 61000.3.3 – Power Line Flicker

SOUTH KOREA STATEMENTS

	1. Equipment Name/Model Name: Komodo-X / Komodo-X
	2. Registration No.: R-R-DV5-2023KX001, R-R-R3d-2022LSR001
	3. Applicant Name: (주) 디브이인사이드
	4. Manufacture Date: 2023
	5. Manufacturer/Country of Origin: RED Digital Cinema, LLC / USA

JAPAN STATEMENTS

This equipment contains specified radio equipment that has been certified to the Technical Regulation Conformity Certification under the Radio Law.

本機器は、電波法に基づく技術基準適合証明等を受けた特定無線デバイスを使用しております。

The 5GHz band is limited to indoor use by Radio Law.
電波法により5GHz帯は屋内使用に限ります。



EUROPEAN UNION COMPLIANCE STATEMENTS



RED declares that the radio equipment described in this document complies with the EMC Directive (2014/30/EU) and the Low Voltage Directive (2014/35/EU) issued by the Commission of the European Community.

Compliance with this directive implies conformity to the following European Norms (in brackets are the equivalent international standards).

- EN 62368-1 (IEC 62368-1) – Product Safety
- ETSI EN 300 328 Technical requirement for radio equipment
- ETSI EN 301 489 General EMC requirements for radio equipment
- EN 55032 (CISPR 32) Electromagnetic Compatibility
- EN 55035 (CISPR 35) Immunity Requirements
- EN 61000-3-2 (IEC 61000-3-2) Harmonic Current Emissions
- EN 61000-3-3 (IEC 61000-3-3) Voltage changes, voltage fluctuations and flicker
- EU 2015/863 RoHS Directive

WASTE ELECTRICAL AND ELECTRONIC EQUIPMENT (WEEE)

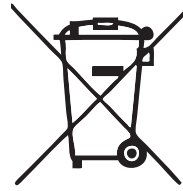

The Waste Electrical and Electronic Equipment (WEEE) mark applies only to countries within the European Union (EU) and Norway. This symbol, on the product and accompanying documents, means that used electrical and electronic products should not be mixed with general household waste. For proper treatment, recovery and recycling, take this product to designated collection points where it will be accepted free of charge. Alternatively, in some countries you may

be able to return your products to your local retailer upon purchase of an equivalent new product.

Disposing of this product correctly will help save valuable resources and prevent any potential negative effects on human health and the environment, which could otherwise arise from inappropriate waste handling. Contact your local authority for further details of your nearest designated collection point. Penalties may be applicable for incorrect disposal of this waste, in accordance with your national legislation. For business users in the European Union, if you wish to discard electrical and electronic equipment, contact your dealer or supplier for further information.

RESPONSIBLE PARTY

RED Digital Cinema
94 Icon
Foothill Ranch, CA 92610
USA

SAFETY INSTRUCTIONS

- This equipment is intended to be used by instructed personnel and is not intended to be used by children.
- DO NOT use the camera or accessories near water. Avoid exposing your camera to moisture. The unit is not waterproof, so contact with water could cause permanent damage to the unit as well as electric shock and serious injury to the user. DO NOT use the camera in the rain or under other conditions with high moisture without appropriate protection, and immediately remove power source if camera or accessories are exposed to moisture.



WARNING: To reduce the risk of fire or electric shock, do not expose the camera to rain or moisture.

- DO NOT point the camera directly into extreme light sources such as the sun or lasers. Permanent damage to optical path or sensor may occur, which is not covered by manufacturer's warranty.
- DO NOT expose your camera to excessive vibration or impact (shock). Be careful not to drop your camera. Internal mechanisms may be damaged by severe shock. Mechanical alignment of optical elements may be affected by excessive vibration.
- ELECTROMAGNETIC INTERFERENCE: The use of devices using radio or other communication waves may result in the malfunction or interference with the unit and/or with audio and video signals.
- Clean only using a dry cloth. When cleaning your camera, remember that it is not waterproof and moisture can damage electronic circuitry. DO NOT rinse or immerse any element of the camera, lens or other accessory, keep them dry at all times. DO NOT use soaps, detergents, ammonia, alkaline cleaners, and abrasive cleaning compounds or solvents. These substances may damage lens coatings and electronic circuitry.
- Maintain sufficient ventilation—DO NOT block any ventilation openings or obstruct cooling fan airflow.



CAUTION: Proper camera ventilation requires a minimum 0.5" (1.25 cm) clearance between the camera ventilation openings and external surfaces. Verify that objects that can block the fan intake and exhaust ports do not impede airflow. Failure to permit adequate airflow may result in overheating of the camera, degraded operation, and in extreme situations, damage to the camera.



WARNING: Media cards can become very hot during prolonged recording sessions. When ejecting the media card, let it cool before touching it with bare fingers.

- DO NOT operate or store near any heat sources such as radiators, heat registers, stoves, or any other apparatuses that produce heat. Store in a protected, level and ventilated place. Avoid exposure to temperature extremes, damp, severe vibration, strong magnetic fields, direct sunlight or local heat sources during storage. Remove any batteries from the camera before storage. Recommended storage and usage temperatures for your camera, lenses and other accessories are:
 - Operating range: 32° F to 104° F (0° C to 40° C)
 - Storage range: -4° F to 122° F (-20° C to 50° C)
- If there are any performance issues with your camera or accessories when operating within this temperature range, submit a support ticket to <https://support.red.com>.

- DO NOT bypass the third prong of the grounding-type plug on the power cord of the included power adaptor. A grounding-type plug has two blades and a third "grounding" prong. The third prong is provided for your safety. You must connect the plug to an outlet with a protective earth connection. If the grounding-type plug does not fit into your outlet, do not attempt to modify the plug or outlet, consult a qualified electrician.
- Protect all power cords from being pinched, walked on, or driven over by a vehicle. Replace any power cords suspected of sustaining damage due to crushing or other forms physical damage.



CAUTION: Install this camera in a proper support system that can handle the entire weight of the camera and the accessories. Secure the camera by using the ¼-20 and/or the 3/8-16 mounting points located on the bottom of the camera. Always verify that the screws are tightened properly. When the camera is not properly attached, or is placed on an unstable surface, the camera can fall and cause injury or be damaged.



CAUTION: Products marked with this symbol are Class 2 devices. These double insulated devices are not provided with a grounding type plug.



CAUTION: The power cord plug for the included power adaptor is used as the power disconnect. To disconnect all power from the power adaptor, unplug the power cord plug from the wall outlet. During use, the power cord plug should remain easily accessible at all times.

- Lithium-ion batteries may be subject to special handling requirements pursuant to federal and local laws. Refer to specific shipping instructions included with your battery regarding proper transport of your battery. Do not handle your battery if it is damaged or leaking. Disposal of batteries must be in accordance with local environmental regulations. For example, California law requires that all rechargeable batteries must be recycled by an authorized recycle center. Storing batteries fully charged or in high temperature conditions may permanently reduce the life of the battery. Available battery capacity may also be temporarily lessened after storage in low temperature conditions.



WARNING: DO NOT expose the battery to excessive heat.



CAUTION: Refer all service and repair to qualified RED service personnel. To reduce the risk of electric shock, and damage to the camera or accessories, DO NOT attempt to perform any servicing other than any procedures that are recommended in the operating instructions.



INDOOR USE ONLY: This device is designed primarily for indoor use.

- El aparato no debe quedar expuesto a goteo o salpicaduras por líquidos.

BATTERY STORAGE AND HANDLING



WARNING: Failure to read, understand, and follow these instructions may result in overheating, chemical leakage, smoke emission, fire, or other potentially harmful results.



WARNING: Only replace the battery with a battery of the same type, or with a battery that is equivalent.

- Read and adhere to all safety instructions provided by the manufacturer of the batteries.

- Always follow proper battery handling and storage practices. Improper handling and failure to abide by proper storage instructions may cause permanent damage to batteries, or degrade battery charge holding capacity. Improper handling practices or failure to comply with instructions may also put you at risk.
- Lithium-Ion batteries, like the REDVOLT Micro-V, self-discharge over time. When storing for long periods of time, store batteries separately from the camera or charger and remember to charge batteries to a capacity level of 40% to 60%. If batteries will be stored for long periods of time, RED recommends that you check the charge level at least once every six (6) months, and recharge batteries to a capacity level of 40% to 60%.
- When not in use, remove the battery from the camera or charger and store the battery in a cool, dry place. Avoid extreme hot temperatures (such as inside a hot car), corrosive gas, and direct sunlight. The optimal storage temperature for batteries is between -4° F to 68° F (-20° C to 20° C).



WARNING: Batteries stored in a discharged state for long periods of time may self-discharge and lose the ability to hold a charge.



WARNING: If recharging operation fails to complete even after a specified recharging time has elapsed, immediately stop further recharging.

- DO NOT store batteries in a fully charged state for extended periods of time.
- DO NOT store batteries in a fully discharged state for extended periods of time.
- DO NOT store batteries in the camera or in a charger for extended periods of time.
- DO NOT use batteries for purposes other than their intended use.
- DO NOT store batteries in extreme hot or cold temperatures.
- DO NOT store batteries in direct sunlight.
- DO NOT disassemble or modify the battery.
- DO NOT overcharge batteries. Overcharging may increase internal temperature beyond the recommended limits and cause permanent damage to the battery.
- DO NOT connect the positive (+) and negative (-) terminals to a metal object such as a wire.
- DO NOT transport or store the battery together with metal objects such as jewelry, hairpins, etc. as they may generate heat if they come into contact with the battery.
- DO NOT discard the battery into fire or heat.
- DO NOT store, use, or recharge the battery near a heat source such as a fire or a heater.
- DO NOT allow the battery to get wet.
- DO NOT pierce the battery with pointed or other sharp objects.
- DO NOT step on, throw, or strike the battery with a hammer.
- DO NOT use a battery that appears to be deformed or damaged.
- DO NOT directly solder the battery.
- DO NOT put the battery into a microwave oven or a pressurized container.
- DO NOT use or subject the battery to intense sunlight or hot temperatures such as in a car in hot weather.
- DO NOT use it in a location where static electricity may be present.
- DO NOT exceed the recharging temperature range of 32° F to 104° F (0° C to 40° C).
- Store the battery in a location where children cannot reach it.
- If the battery leaks or gives off a bad odor, discontinue use immediately.
- If the battery gives off an odor, generates heat, becomes discolored or deformed, or in any way appears abnormal during use, recharging or storage, immediately remove it from the equipment or battery charger and discontinue use.
- If electrolyte begins leaking from the battery and comes into contact with your skin or clothing, immediately wash it away with running water. Failure to do this may result in skin inflammation.

- If the battery leaks and the electrolyte reaches the eyes, do not rub them. Instead, rinse the eyes with clean running water and immediately seek medical attention. Failure to do this may result in eye injury.

1. INTRODUCTION



Figure: RED KOMODO-X™ camera

RED KOMODO-X™

KOMODO-X is the next evolution in the KOMODO family, multiplying the frame rates, dynamic range, and usability of the original KOMODO to break new grounds.

NEXT GENERATION KOMODO SENSOR

KOMODO-X features the same sized 6K S35 Global Shutter sensor as the KOMODO, but with a ground up redesign and key architecture improvements.

Improved detail and color in shadows, paired with double the frame rates at 6K 80P and 4K 120P makes KOMODO-X an even more powerful tool for creatives.

ENHANCED BODY AND I/O

With key improvements for professional workflows, the KOMODO-X now shares many features with the DSMC3 line while still maintaining the impressively small KOMODO form factor. An integrated micro V-Lock allows for direct attachment of professional micro V-Lock batteries without the need for adapters and is also compatible with the upcoming RED PRO I/O Module to provide auxiliary power and compatibility with full sized V-Lock and Gold Mount batteries.

A reinforced RF lens mount with locking mechanism maintains the flexibility of toolless switching between multiple lens mount types, while providing the stability and rigidity professionals need. KOMODO-X is also fully compatible with /i PL lenses using the RED RF to PL Adapter.

12G SDI, full sized DC-IN, USB Type-C, and a phantom powered locking audio connector further enables KOMODO-X to seamlessly integrate into any professional workflow. KOMODO-X is compatible with [DSMC3™ RED® 5-Pin to Single 3.5 mm Adapter](#) to support existing KOMODO microphones, or the [DSMC3™ RED® 5-Pin to Dual XLR Adapter](#) for general purpose XLR microphones.

An integrated 2.9" LCD allows for simplified control and image preview in compact setups. For more precise monitoring, KOMODO-X supports the DSMC3 7" Touch LCD which provides a daylight viewable, high-resolution, camera top monitor and control solution without the mess of cables.

IP CONNECTED

KOMODO-X is a powerful platform for any IP based workflow, from Virtual Production to Live Broadcast. With integrated USB Type-C connection and built-in Wi-Fi, remotely control the camera using RED Control or RED Control Pro, as well as IP media offloading using FTPS or in-camera Cloud Uploading functionality. In addition, KOMODO-X supports frame-accurate PTP synchronization or tri-level genlock sensor sync with the ability to offset on the fly to support multi-camera LED volume productions.

KOMODO-X also supports RED Connect, a licensed feature that allows for live broadcasting of 6K images directly from the camera over IP, expanding RED's cinematic imagery into boundless new uses.

QUICK REFERENCE

Refer to the [Quick Reference](#) section to get familiar with this guide and the camera.

R3D FILE FORMAT AND REDCODE

All videos and frames are recorded to the R3D[®] file format. The R3D file format was developed by RED to provide an efficient and manageable RAW video data format that promotes advanced post-production editing capabilities. In the R3D file format, the digital image received from the sensor is formatted as a pixel-defect corrected (but in all other aspects unprocessed) 16-bit per pixel RAW data frame. Each RAW frame, or sequence of RAW frames in a clip, is compressed using proprietary REDCODE[®] RAW compression, then stored to media.

RAW data is recorded independently of any RGB domain color processing such as ISO, White Balance, or other RGB color space settings. Instead, color parameters are saved as reference metadata; that is, color is not burned into the recorded RAW data. This innovative recording technique promotes flexibility in RGB color processing. It allows you to defer color correction to post-production, or to adjust the image color in the field, without changing the recorded RAW data image quality or dynamic range.

REDCODE is a compression codec that reduces R3D RAW files down to a manageable size, allowing the media to record longer. The ability to compress RAW data is one of the significant technological advances that RED has brought to the motion picture industry.

GLOBAL SHUTTER

This camera employs global shutter technology. This technology exposes all of the sensor's pixels in each frame simultaneously, unlike a rolling shutter that exposes lines of pixels (each with a delay) causing image artifacts on fast-moving objects. Global shutter technology not only improves the visual appearance of this camera's images, it also eliminates tracking and matte-painting distortions during post production.

IMAGE PROCESSING PIPELINE

This camera uses RED's Image Processing Pipeline 2 (IPP2). In IPP2, the advanced RED color space (REDWideGamutRGB) allows the camera to use every color that the sensor can generate up to the clipping threshold. Then the camera encodes the image using Log3G10, a gamma curve that retains extreme highlight and shadow detail. Using the advanced color space and gamma curve, RED IPP2 allows you to grade and make color adjustments in post-production, instead of in-camera. IPP2 also allows the camera to use a [CDL](#) for grading. For more information about IPP2, refer to the [RED IPP2](#) support page.

SHOOT FOR VIDEO AND STILLS

High resolution video, such as the digital footage captured by the camera, has surpassed the detail necessary to produce professional full-sized prints. Because the camera is able to record RAW video at high frame rates and resolution, this camera is ideally suited to capture video and still images simultaneously while still preserving the full flexibility that RAW still photographers have come to expect.

POST-PRODUCTION

Many non-linear editing systems (NLEs) can open and edit RED footage, allowing full RAW control and flexibility without any need to re-transcode. Each NLE version may have specific compatibility requirements, such as camera firmware version or camera type. Before shooting, make sure you check all of the compatibility requirements.

You can open and/or edit R3D files by using one of the following products:

- **REDCINE-X PRO:** RED's proprietary application. Download [REDCINE-X PRO for Windows](#) or [REDCINE-X PRO for Mac](#) from www.red.com/downloads.
- **Adobe Premiere Pro**
- **Avid Media Composer**
- **DaVinci Resolve**
- **Final Cut Pro X:** Requires you to download the [RED Apple Workflow Installer](#) from www.red.com/downloads.
- **Foundry Nuke**
- **Assimilate Scratch**
- **AutoDesk Flame**
- **ColorFront Transkoder** (beta for latest support)
- **Pomfort Silverstack**

NOTE: Third-party applications may have limited compatibility with R3D files. Third-party developers must use the most recent [R3D SDK](#) to offer compatibility with the latest RED firmware.

POST-PRODUCTION WITH REDCINE-X PRO

REDCINE-X PRO is a professional one-light coloring tool set, equipped with an integrated time line, and with a collection of post effects software. REDCINE-X PRO provides the ideal environment to review recorded footage, edit metadata, organize projects, and prepare your R3D files. You can use REDCINE-X PRO or any of the compatible third-party NLEs to edit R3D files.

ADDITIONAL RESOURCES

- **RED.com:** Visit the [official RED website](#) for the latest information about RED products.
- **RED Downloads:** Go to [RED Downloads](#) to download the latest firmware, operation guides, and post-production software.
- **RED 101 Articles:** RED offers [in-depth technical articles](#) about RED cameras, post-production, and digital cinematography.
- **RED TECH Videos:** RED offers [videos](#) about understanding and using RED cameras.
- **RED Support:** Visit the [RED SUPPORT site](#) for support articles or to file a support ticket.

2. QUICK REFERENCE

Congratulations new RED KOMODO-X™ 6K S35 camera owner. This quick reference topic helps you get familiar with this guide and the [Camera Body](#). It includes links to topics about configuring the camera to fit your recording requirements, and for learning the basic operation of the camera.

PREPARING THE CAMERA HARDWARE

Prepare the camera hardware for recording by:

- Attaching accessories (refer to [Accessories](#))
- Installing [Lenses and Adapters](#)
- [Inserting the Media](#)
- Connecting a power source (refer to [Power](#) or [Accessories](#))
- [Turning On the Camera](#)

PREPARING THE CAMERA SYSTEM

Configure the camera settings to prepare for recording by:

- Configuring the camera system settings (refer to the [System Settings Menu](#))
- [Upgrading the Firmware](#) and [Upgrading the DSMC3™ RED® Touch 7.0" LCD Firmware](#)
- Calibrating the camera using the [Calibrate](#) feature
- Formatting the media (refer to [Secure Format](#))
- Specifying the desired recording resolution (refer to [Format](#))
- Configuring the [Recording Frame Rate](#) and [Project Time Base](#)
- Setting the exposure (refer to [Shutter](#))
- Configuring the monitoring tools and reviewing the monitored image (refer to the [Monitoring Menu](#))
- Reviewing the camera status (refer to [System Status](#))

RECORDING

Start recording your project.

- Record by pressing the REC button on the [Camera Body](#), [Outrigger Handle](#), or [RED® Compact Top Handle](#)
- Record by using the Top LCD (refer to [DSMC3™ RED® Touch 7.0" LCD](#))
- Record by using an external trigger (refer to [Extension Port](#))
- Start, stop, and control the camera by using USB-C (refer to [USB-C Configuration](#))
- Start, stop, and control the camera by using Wi-Fi (refer to [How To](#))

PROCESSING FOOTAGE

Perform post-production using any of the standard applications.

- Adobe® Premiere® Pro
- Avid® Media Composer®
- DaVinci Resolve®
- Final Cut Pro X®

NOTE: Third-party applications may have limited compatibility with R3D files. Third-party developers must use the most recent [R3D SDK](#) (8.3 or later) to offer compatibility with the latest RED firmware.

3. CAMERA COMPONENTS

CAMERA BODY

This section describes the **Front**, **Top**, **Left**, **Right**, **Back**, and **Bottom** of the camera, and identifies the controls, buttons, **Camera Body LEDs**, and the lens mount on the body.

CAMERA BODY CONTROLS AND FEATURES

This section describes the controls and features of the camera.

FRONT

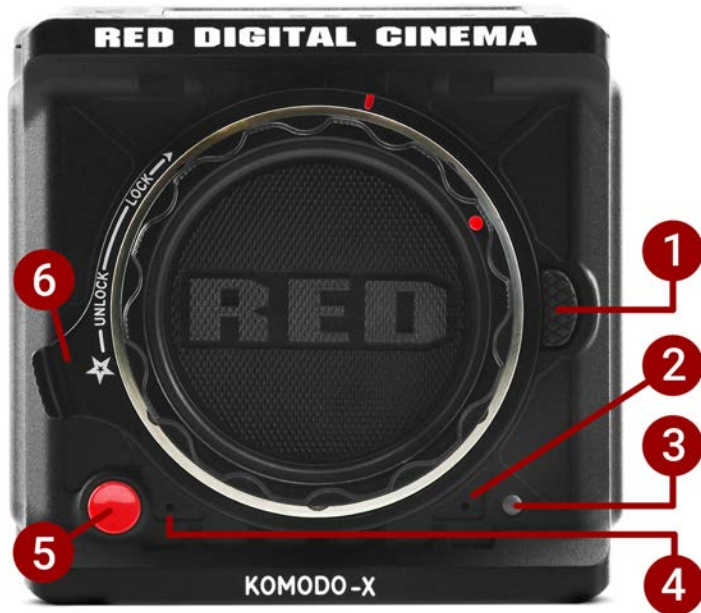

Figure: Camera Body Front Controls and Features

#	ITEM	DESCRIPTION
1	Lens release	Press to release RF-type lenses
2	Mic 1	Left Internal Microphone channel
3	Tally light	Tally light (refer to Camera Body LEDs and Indicators)
4	Mic 2	Right Internal Microphone channel
5	Front REC button	Press and release the REC button to toggle between record start and stop
6	Lens locking ring	Rotate to lock and unlock lenses

TOP



Figure: Camera Body Top Controls and Features

#	ITEM	DESCRIPTION
1	LCD Touchscreen	Camera Onboard LCD Touchscreen
2	MENU (BACK) Button	Menu button, Back button
3	Up Arrow (LOCK) Button	Navigates up in the menu and locks/unlocks the UI when pressed along with the other Lock button
4	Down Arrow (LOCK) Button	Navigates down in the menu and locks/unlocks the UI when pressed along with the other Lock button
5	Select Button	Selects the highlighted menu item
6	Playback Button	Opens the Playback screen
7	1/4-20 Mounting Holes	1/4-20 mounting holes for optional accessories (refer to Outrigger Handle, DSMC3™ RED® Touch 7.0" LCD)
8	Accessory Port	Connection port for accessories (refer to Outrigger Handle, DSMC3™ RED® Touch 7.0" LCD)

LEFT

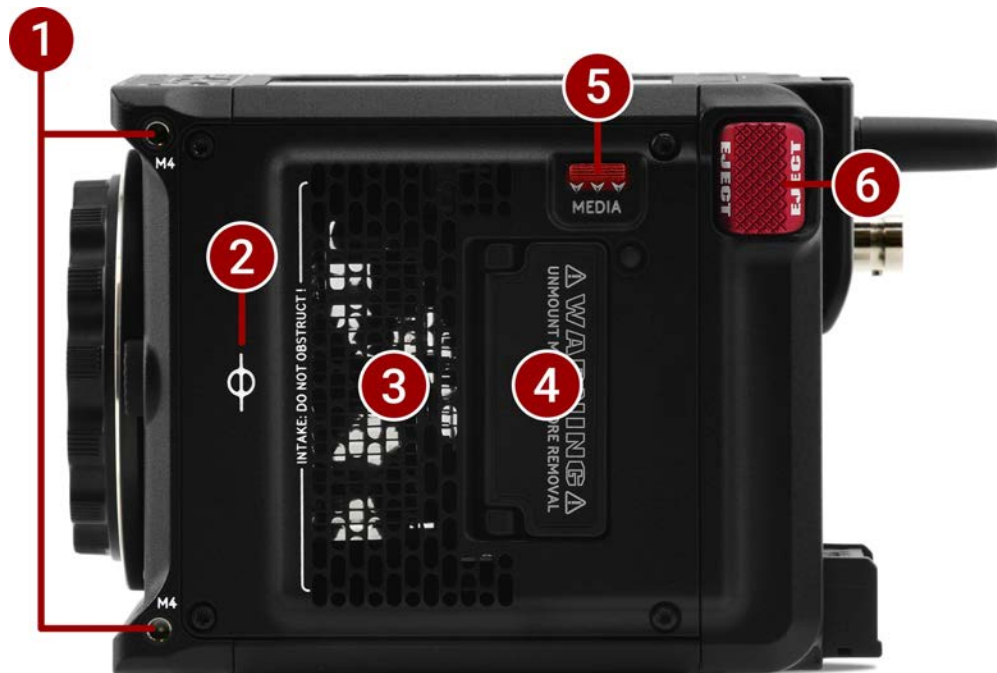

Figure: Camera Body Left Controls and Features

#	ITEM	DESCRIPTION
1	M4 Mounting Holes	Two (2) M4 mounting points for accessories
2	Focus Plane	Focus plane indicator symbol
3	Air intake	Air intake for thermal management
4	Media compartment	CFexpress Type B compartment
5	Access media	Latch for the CFexpress Type B media compartment door
6	EJECT Button	Micro-V battery eject button

RIGHT



Figure: Camera Body Right Controls and Features

#	ITEM	DESCRIPTION
1	Wireless antenna	Wi-Fi antenna mounted to a female RP-SMA connector. Supports dual band 2.4 GHz or 5 GHz
2	Power LED	Displays the camera ready status (refer to Camera Body LEDs)
3	ON/OFF switch	Slide up to turn on the camera and slide down to turn off the camera
4	Speaker	Beep speaker for audible feedback
5	Right REC button	Assignable full-press and half-press button
6	Exhaust	Exhaust for thermal control
7	Focus plane	Focus plane indicator symbol
8	M4 mounting holes	Two (2) M4 mounting points for accessories

BACK



Figure: Camera Body Rear Controls and Features

#	ITEM	DESCRIPTION
1	Micro V-Lock battery mount	14.4 V Micro V-Lock mount(refer to REDVOLT[®] MICRO-V Battery and REDVOLT[®] NANO-V Battery)
2	Wireless antenna	Wi-Fi antenna mounted to a female RP-SMA connector. Supports dual band 2.4 GHz or 5 GHz
3	USB Type-C port	USB Type-C Port for USB-C connection
4	12G-SDI port	Full-size 12G-SDI BNC port for SDI monitor connection ^{1,2}
5	Headphone port	3.5 mm stereo headphone output
6	Audio port and LED	5-Pin 00B ODU for 2 channel audio (Line, Mic, and +48V)
7	9-pin Extension Port	9-pin 0B ODU port (refer to Extension Port)
8	6-pin DC-IN port and LED	6-pin 1B ODU for DC-IN (11-17 Volts) and power status LED (refer to 6-pin DC-IN)

1. Use certified 12G-SDI cables.

2. **WARNING:** Always connect the accessories' DC power cable (or batteries) before connecting the BNC SDI cable. Always remove the BNC SDI cable before removing the accessories' DC power cable (or batteries). For more information, refer to [Preventing Damage to SDI Outputs](#).

BOTTOM



Figure: Camera Body Bottom Controls and Features

#	ITEM	DESCRIPTION
1	Mounting Points	One (1) 1/4"-20 mounting hole and one (1) 3/8"-16 mounting hole
2	Registration Points	Indented alignment points
3	Service Port	For RED service only - DO NOT REMOVE

CAMERA BODY LEDS

FRONT LED



Figure: Camera LED, Front

#	ITEM	COLOR	DESCRIPTION
1	Tally Indicator LED	Red	When enabled, this LED is ON when the camera is recording. For information about enabling this LED, refer to Indicators .

LEFT SIDE LED



Figure: Camera LED, Left Side

#	ITEM	COLOR/FLASHING	DESCRIPTION
1	CFexpress Media LED	Off	No media mounted
		Green	Preview; media mounted with > 10% of media space available
		Amber	Recording finalizing or playback mode
		Amber flashing slow	Formatting media
		Red flashing slow	Media mounted with >5% and <= 10% of media space available
		Red flashing fast	Media mounted with <= 5% of media space available
		Red	Recording

RIGHT SIDE LEDS



Figure: Camera LED, Right Side

#	ITEM	COLOR/FLASHING	DESCRIPTION
1	Power Status (ON)	Off	Camera OFF
		Amber	Camera booting
		Green	Camera ON
		Amber flashing	Camera on; 5 to 10 min of battery time available
		Red flashing	Camera on; < 5 min of battery time available
		Red	Camera shutting down
2	Record Status (REC)	Off	No media present
		Green	Ready to record
		Red	Recording
		Amber	Finalizing
		Red flashing slow	Media mounted with >5% and <= 10% of media space available
		Red flashing fast	Media mounted with <= 5% of media space available
3	Power (firmware update)	Flashing green	Firmware update in progress
		Flashing red	Firmware update error (refer to Upgrading the Firmware)

BACK LEDS



Figure: Camera LEDs, Rear

#	ITEM	COLOR	DESCRIPTION
1	Phantom power	Blue	Indicates that the +48 V Phantom Power is enabled
2	DC-IN	Green	DC-IN is present and / or the battery is fully charged
		Flashing Amber	Communicating with, and evaluating the battery
		Amber	Charging connected batteries
		Red	Error charging the batteries

LENSES AND ADAPTERS

This section lists the compatible lenses and adapters for the camera. It also provides the steps for [Attaching Lenses](#) and [Removing Lenses](#).

For more information on a specific lens or adapter, refer to the original manufacturer's instructions.

WARNING: When the camera is not in use, protect lenses and the camera sensor by attaching the lens caps and camera mount cap.



Figure: Camera with mount cap installed.

Incompatible lenses may not register on the camera UI or show any UI lens information or menu controls. The camera can control compatible lenses electronically, including the following features:

- Iris - The UI menu is enabled and the camera can control the lens Iris
- Autofocus - The UI menu is enabled for lenses that support autofocus
- Image Stabilization - The UI indicates that image stabilization is present
- Control Ring - The UI menu is enabled and the camera can use the control ring

For more information, refer to the [Lens](#) menu.

COMPATIBLE LENSES

The latest RED-tested and approved lenses are listed on the KOMODO-X section of [RED Support](#).

LENS WEIGHT AND LENS SUPPORT

Use a lens support system when mounting heavy or long lenses to your camera.

When mounting a heavy or long lens, ensure that the full weight of the lens is never directly on the camera or lens mount. Mount the lens to the support system first, and then carefully mount the lens to the camera.

COMPATIBLE MOUNT ADAPTERS

RED tested the following adapters and determined that they are compatible with the camera:

- KOMODO-X™ RF to PL Adapter (refer to [KOMODO-X™ RF to PL Adapter Pack](#))
- Canon Mount Adapter EF-EOS R
- Canon Drop-In Filter Mount Adapter EF-EOS R with Variable ND Filter / Clear Filter / Circular Polarizer

ATTACHING LENSES

1. Unlock the locking ring by rotating it to the fully counterclockwise position.
2. Press and hold the lens release button on the camera. While holding the lens release button, turn the camera lens mount cap counter-clockwise until it stops, and remove it from the camera. If the lens locking ring rotates while removing the cap, make sure that you hold the locking ring tab in place while rotating the cap.
3. Remove the rear lens cap from the mount end of the lens.
4. Align the red dot on the lens mount with the red dot on the camera lens mount, and insert the lens mount of the lens in the camera lens mount opening.
5. Turn the lens clockwise until it clicks in place. If the lens locking ring rotates while attaching the lens, make sure that you hold the locking ring tab in place while rotating the lens or adapter.
6. Gently tighten the locking ring. **DO NOT OVER-TIGHTEN THE LOCKING RING.**
7. Store the camera lens mount cap and the rear lens cap together in a dust free location.

REMOVING LENSES

1. Loosen the locking ring gently.
2. Press and hold the lens release button on the camera. While holding the lens release button, turn the lens counter-clockwise until it stops, and remove it from the camera. If the lens locking ring rotates while removing the lens, make sure that you hold the locking ring tab in place while rotating the lens or adapter.
3. Align the red dot on the camera lens mount cap with the red dot on the camera lens mount, and attach the cap to the camera.
4. Gently tighten the locking ring. **DO NOT OVER-TIGHTEN THE LOCKING RING.**
5. Attach the rear lens cap to the lens.
6. Store the lens with the front and rear caps attached.

ONBOARD LCD TOUCHSCREEN



This section describes the structure and layout of the graphical user interface (GUI) for the Onboard LCD touchscreen. Advanced GUI menu controls enable convenient access to menus, camera features, and critical camera information.

NOTE: After 1 hour of inactivity, the touchscreen will go to sleep. Tap the touchscreen or touch any button to wake the touchscreen. The touchscreen will not sleep while the camera is recording.

The Onboard LCD Touchscreen home page contains the following features:

STATUS BAR



The **Status Bar** contains the button for displaying the Home screen and Menu screen. It also contains status icons for various camera settings and inputs.

When you tap the Home/Menu toggle button (RED logo), the camera toggles the display between the menu page and the home page:

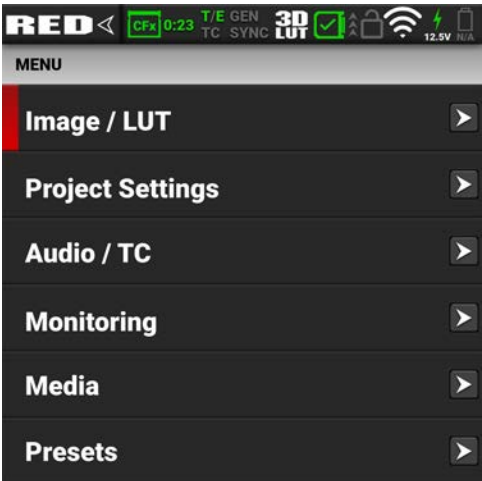

When you tap the Status bar icons the **Status Page** displays:

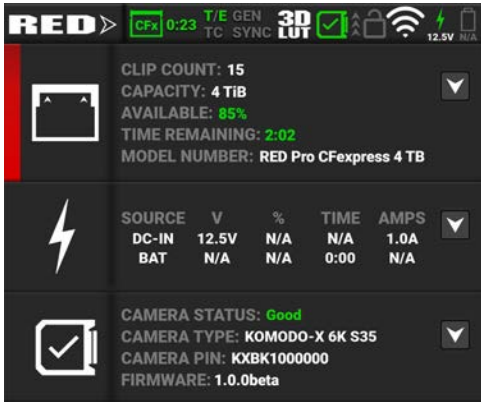

EXPOSURE

The Exposure section of the Onboard LCD home page displays the RGB exposure levels for the camera.

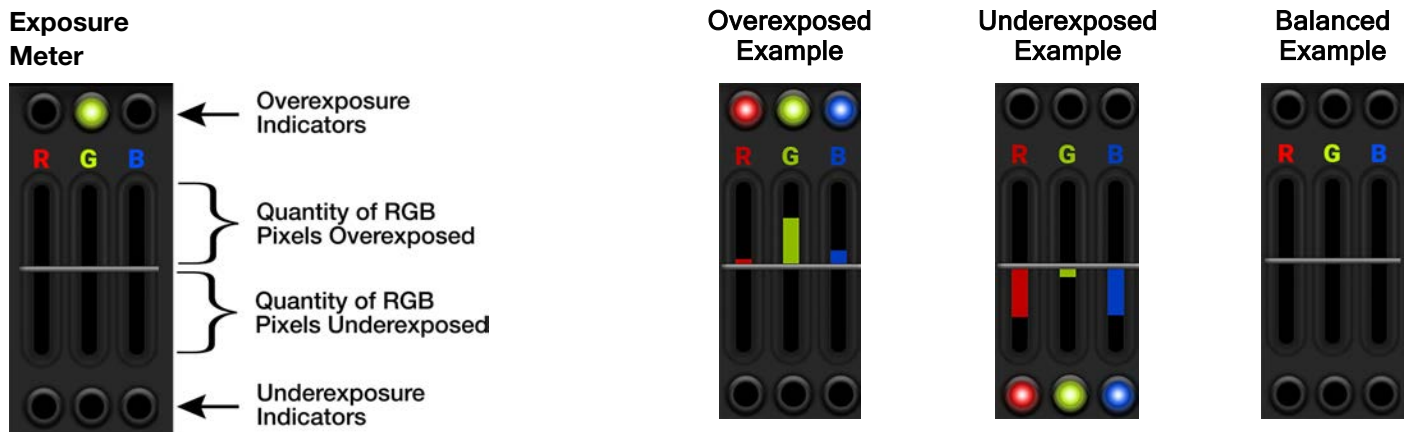

RGB Exposure displays the pixel exposure quantity of the separate RGB channels and indicates when a channel is underexposed or overexposed. This meter measures the raw image data regardless of the ISO and LUT settings.

The top and bottom RGB lights illuminate when a small number of pixels on the sensor are overexposed or underexposed. This indicates that a small bright or dark area is in the image.

The level bars show the levels of overexposed and underexposed RGB pixels on the sensor. Adjust the settings on the camera to compensate.

Tap the Exposure section to toggle between this display and the **Monitoring Tools** page display.

MEDIA / HISTOGRAM

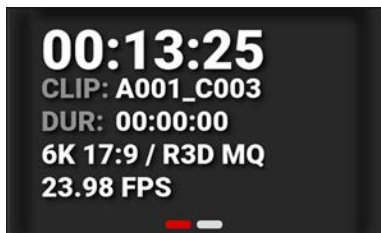

The Media section of the Onboard LCD home page displays the Timecode or Edgecode, clip ID, clip duration, resolution/format, and frame rate for the camera. Tap the Media section to toggle between this display and the Histogram display.

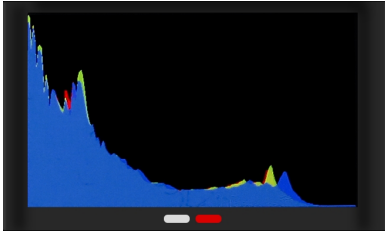

The Histogram section of the Onboard LCD home page displays the image color histogram. Tap this area to toggle between this display and the Media display. For more information, refer to [Histogram](#).

AUDIO

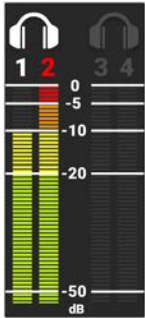

The Audio section of the Onboard LCD home page displays the audio levels for the camera. Tap the Audio section to toggle between this display and the [Audio Tools](#) display.

The Audio VU meters display the audio levels in decibel (dB) for the selected channels. Refer to the Audio / TC Menu section for more information about the audio channels.

In this example, channel 2 displays the VU meter clipping at maximum dB.

CAMERA DESIGNATION AND REC BUTTON



The Camera Designation and Record button on the Onboard LCD touchscreen home page displays the camera letter assigned to the camera (refer to [Slate](#) and [Camera ID](#)). You can tap this area to start pre-recording, and to start and stop recording.

Pre-recording:



Recording:



QUICK SETTINGS



The Quick Settings section of the Onboard LCD home page displays the Quick Settings buttons for changing the most often used camera settings. These settings include **Recording Frame Rate**, **ISO**, **IRIS** (refer to **Lens**), **Shutter**, and **White Balance**.



Tap on a Quick Setting button to change the settings.

Swipe the setting left or right to make a selection.

Tap Edit to manually enter a value.

Tap List to manage which values display in this tool.

Tap on the Quick Setting button to close the selection screen.

Tap and hold the Shutter button to quickly toggle between Time and Angle settings.

Tap and hold the White Balance (WB) button to quickly switch between Kelvin and Presets.

BUTTON NAVIGATION

Pressing the Menu button next to the Onboard LCD touchscreen opens the main menu page. You can select the desired menu items by using the Up, Down, and Select (SEL) buttons. Pressing the Menu button also navigates backwards (BACK) from submenus in the menu tree.

Pressing the Up arrow and the Down arrow simultaneously locks/unlocks the touchscreen and the menu buttons. The Lock icon in the Status bar displays the lock status. The REC button is not locked and it functions normally.

Pressing the Playback button starts and stops playback (refer to **Playback** for more information).

Home Screen



Menu Screen

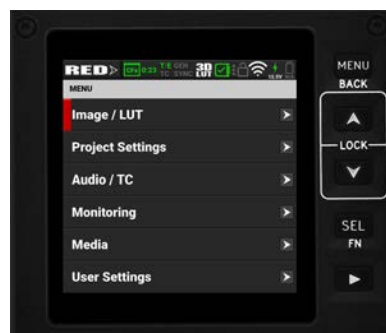

STATUS BAR

The top of the Onboard LCD screen displays the camera status bar.



The Status Bar contains the following button and icons:

- **RED >** Home / Menu Button
- **CFx 0:23** Media Status Icon
- **T/E** Temperature / Exposure Icon
- **TC** Timecode Icon
- **GEN** Genlock Icon
- **SYNC** SYNC Icon
- **3D LUT** Status Bar
- **✓** 3D LUT Icon
- **↑** Network Activity Icon
- **🔒** LCD Lock Icon
- **📶** Wi-Fi Icon
- **⚡** DC-In Icon
- **🔋** Battery Icon

HOME / MENU BUTTON



This button toggles the Onboard LCD display between the Home screen and the Menu screen. The arrow on the button changes direction when toggled.

Home Screen:



Menu Screen:

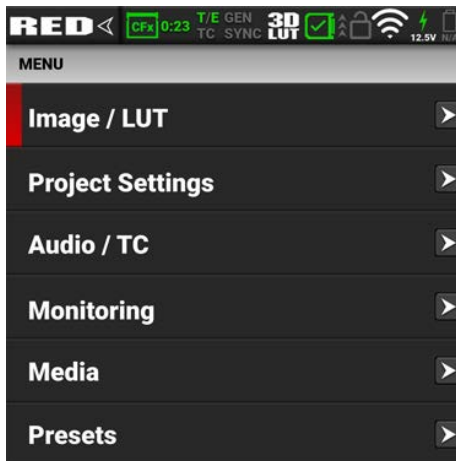

MEDIA STATUS ICON



This icon displays the status of the CFexpress Type B media card, and it displays the recording time remaining for the current camera settings.

The status displayed includes:



Good



Missing



Incompatible

TIMECODE ICON



This icon indicates the state of the Timecode generator connection.



Gray indicates that no Timecode generator signal is detected.



Green indicates that the Timecode source is connected and jammed.



Red indicates that the selected Timecode Source is not present, or not jammed in the last 12 hours.



White indicates that the selected Timecode source is not currently connected but was jammed during the current camera boot.



Yellow indicates that the selected Timecode source has not been jammed in current camera boot but has been within the last 12 hours, or that timecode source is cross-jammed (at a different [Project Time Base](#)).

TEMPERATURE / EXPOSURE ICON



This icon displays the temperature (T) and exposure (E) calibration indicators.

- When T is yellow or red, it indicates that the camera requires sensor re-calibration at the current ambient temperature.
- When E is yellow or red, it indicates that the camera requires sensor re-calibration at the current shutter speed.

Refer to [Calibrating the Sensor](#).

GENLOCK ICON



This icon indicates the state of the Genlock connection.



Gray indicates that no Genlock signal is detected.



Green indicates that the camera is receiving a Genlock signal.



Red indicates that the camera is receiving and is not locked to a Genlock signal.

SYNC ICON



This icon indicates that the Timecode and Genlock signals are synchronized to the camera's frames per second (FPS) settings.



Gray indicates that no synchronization is detected.



Green indicates that the camera is synchronized with the Timecode and Genlock signals.



Yellow indicates that the camera is synchronized using Genlock but not Timecode.

3D LUT ICON



This icon indicates the activation status of 3D LUTs.



Gray indicates that no 3D LUTs are in use.



White indicates that the camera is using a 3D LUT.

CAMERA STATUS ICON



This icon indicates the state of the camera hardware. The different icons and their corresponding status include:



Good: Camera operating as expected.



Attention Required: Camera's calibration requires attention or camera is nearing overheated state.



Overheating: Camera has reached temperature threshold and shut down is imminent.



Shutting Down: Camera is shutting down due to overheating.

NETWORK ACTIVITY ICON



This icon indicates the state of FTPS or Cloud data transfer.



Gray indicates that no network data transfer is occurring.



Green indicates that the camera is transferring FTPS or Cloud data.

LCD LOCK ICON



This icon indicates the state of the Onboard LCD Lock. The states include:



Gray and open indicates that the camera Onboard LCD is unlocked.



White and closed indicates that the camera Onboard LCD is locked.

WI-FI ICON



This icon indicates the state of Wi-Fi connection.



Gray and empty indicates that no Wi-Fi signal is detected.



White bars indicate that Wi-Fi signal is detected (Infrastructure).



White antenna indicates that Wi-Fi signal is broadcasting (Ad-hoc).

DC-IN ICON



This icon indicates the state of DC power connection.



Gray indicates that no DC power is connected.



Green indicates that the camera is receiving DC power and the voltage number is displayed.

BATTERY ICON



This icon indicates the state of the battery connection and charge level. When the voltage is low, it displays the voltage in red.



Gray indicates that no battery is connected.



White indicates that the battery is connected and green shows the relative level of charge remaining.



Yellow indicates 10 minutes of power remaining.



Red indicates less than 5 minutes of power remaining.



Gray question mark indicates no communication with the battery and no power.



White question mark indicates no communication with the battery and power.



Gray exclamation point indicates error communicating with the battery and no power.

STATUS PAGE

The Status page contains camera status information and shortcuts to the associated camera menus:

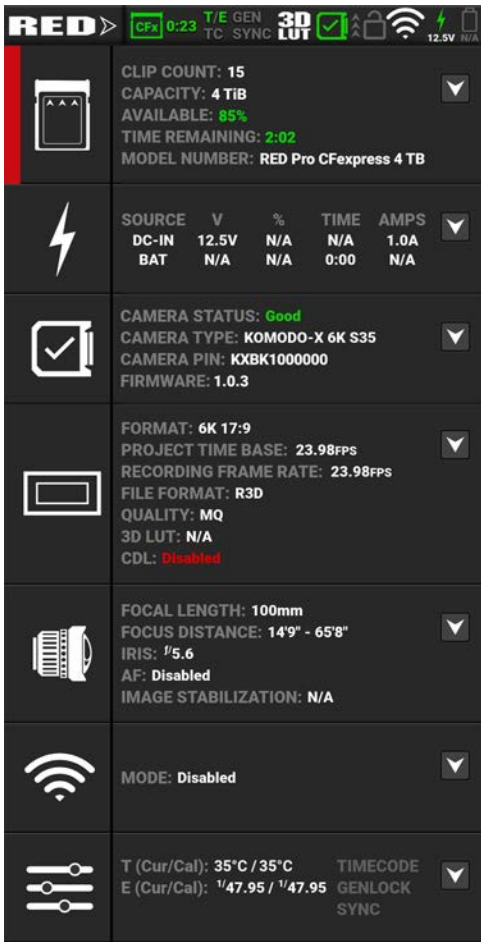

The camera status and menu shortcuts include:

ITEM	DETAILS
Media	Displays the media status and a link to the Media Menu
Power	Displays the power status and a link to the Power settings menu
System Status	Displays the camera temperature status and a link to the System Status menu
Project Settings	Displays the project status and a link to the Project Settings Menu
Lens	Displays the lens status and a link to the Lens settings menu
Wi-Fi	Displays the communication status and a link to the Wi-Fi settings menu
Maintenance	Displays the Temperature and Exposure calibration, the external connection status, and a link to the Maintenance Menu

MONITORING TOOLS



Open the Monitoring tools by tapping on the Exposure section of the Onboard LCD home page.

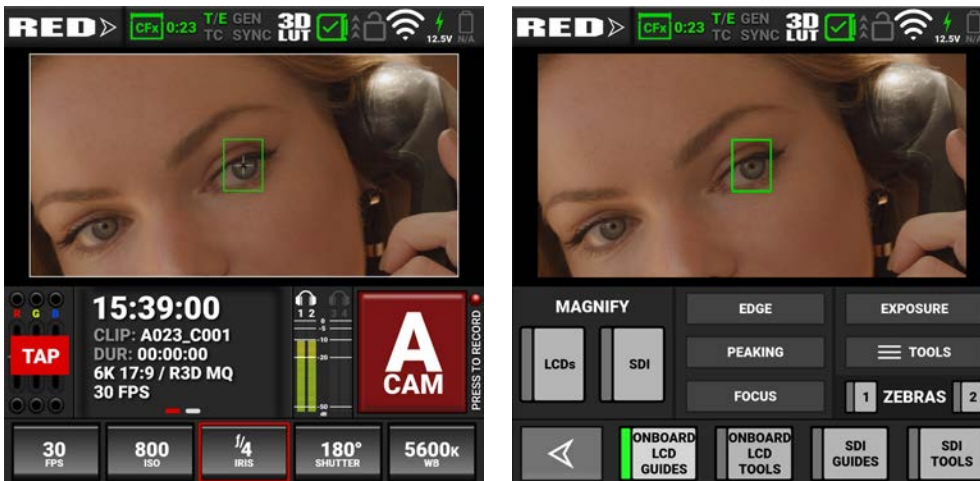

Return to the Onboard LCD home page by tapping the arrow button 

The Monitoring tools provide an easy way to toggle many of the monitoring features on and off. When the features are selected, the buttons indicate the selection.

ONBOARD LCD SWITCHES

The Onboard LCD switches allow you to view or hide the enabled LCD monitor Guides and Tools on the Onboard LCD screen.

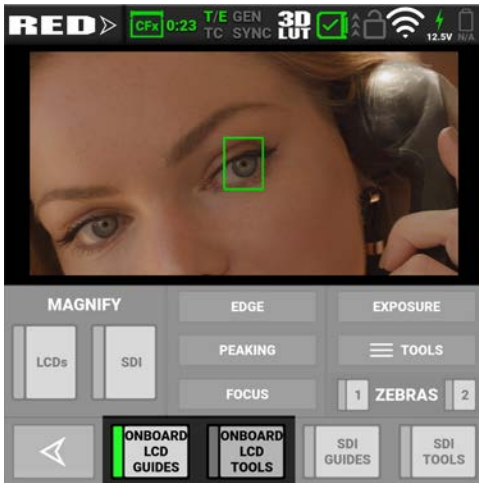

When the switches are selected, the gray bar turns green on the left side of the switch.

The Onboard LCD Guides switch displays the Monitoring **Guides** (frame guides and center guide) on the Onboard LCD.

The Onboard LCD Tools switch displays the Monitoring **Tools** (false color, peaking, zebra) on the Onboard LCD and on Live Stream.

SDI SWITCHES

The SDI switches allow you to view or hide the enabled SDI monitor Guides and Tools on the Onboard LCD screen.



When the switches are selected, the gray bar turns green on the left side of the switch.

The SDI Guides switch displays the Monitoring **Guides** (frame guides and center guide) on the SDI output.

The SDI Tools switch displays the Monitoring **Tools** (false color, peaking, zebra) on the SDI output.

MAGNIFY

The Magnify section allows you to enable or disable magnification on the camera's LCDs (Onboard LCD and Top LCD) and the SDI monitor output. When the switches are selected, the gray bar turns green on the left side of the switch.

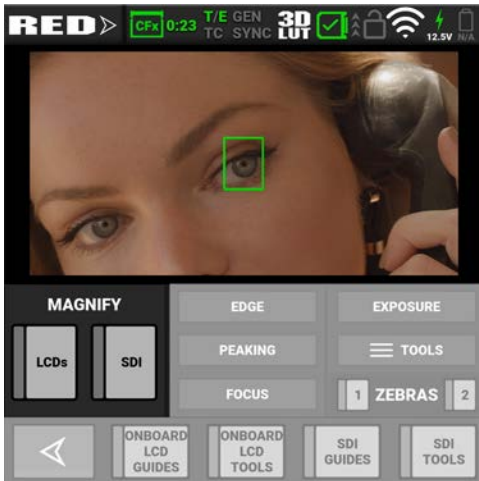

FOCUS

The Focus section allows you to enable or disable one of the focus tools. The focus tool button you select will turn red.

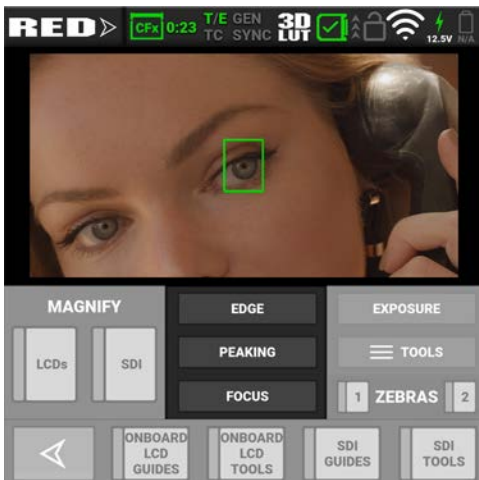

For information about using the Focus tools, refer to [Tools](#).

EXPOSURE

The Exposure section allows you to enable or disable one of the exposure tools. The Exposure tool button you select will turn red.

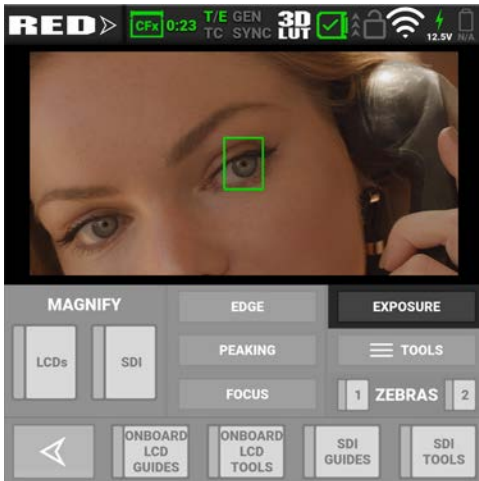

For information about using the Exposure tools, refer to [Tools](#).

TOOLS

The Tools section allows you to open the Monitor Tools menu.

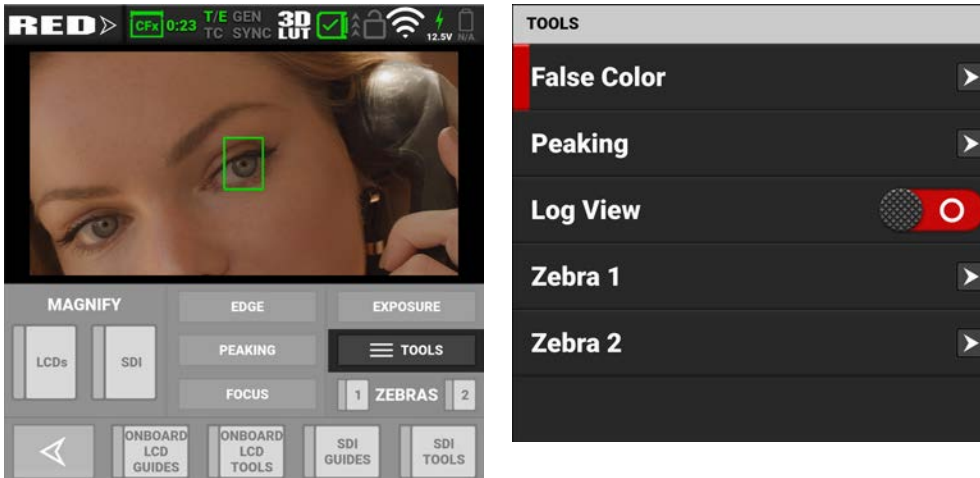

For information about the Monitor Tools menu, refer to [Tools](#).

ZEBRA

The Zebra section allows you to enable or disable the Zebra 1 and Zebra 2 modes. When the modes are selected, the gray bar turns green on the left side of the switch.

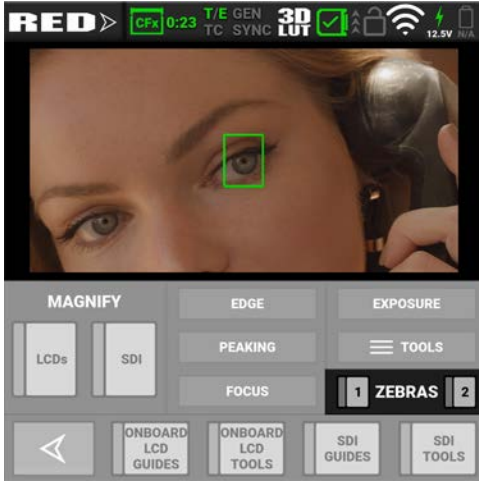

For information about using the two Zebra modes, refer to [Zebra 1](#) and [Zebra 2](#).

HISTOGRAM

NOTE: The Histogram feature is disabled on Monochrome cameras.

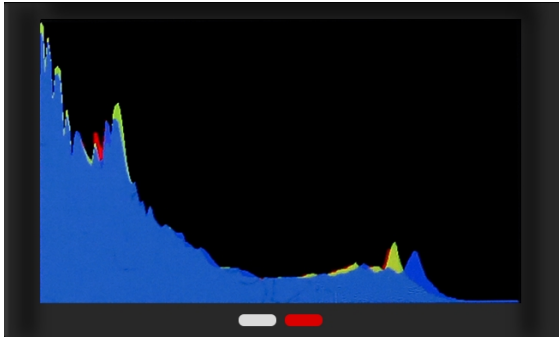

Tap the histogram area to toggle between the Histogram display and the Media display.



The Histogram area of the LCD home page displays an RGB exposure distribution histogram of the final image as it appears on screen. The histogram takes into account exposure elements such as ISO, LUTs, and white balance. The histogram displays the darkest image elements at the far left, the midtones in the middle, and the lightest image elements at the far right. This provides a quick visual tool you can use to determine your overall image exposure levels.

Overexposed Example

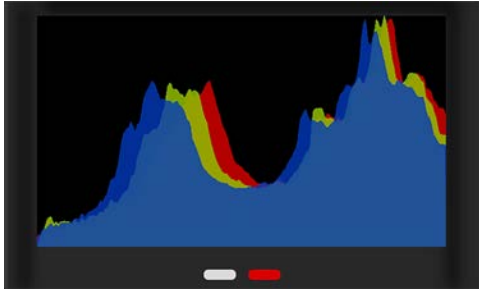

Underexposed Example

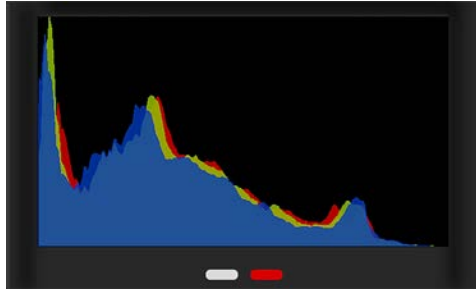

AUDIO TOOLS



Open the Audio tools by tapping on the Audio section of the LCD home page.

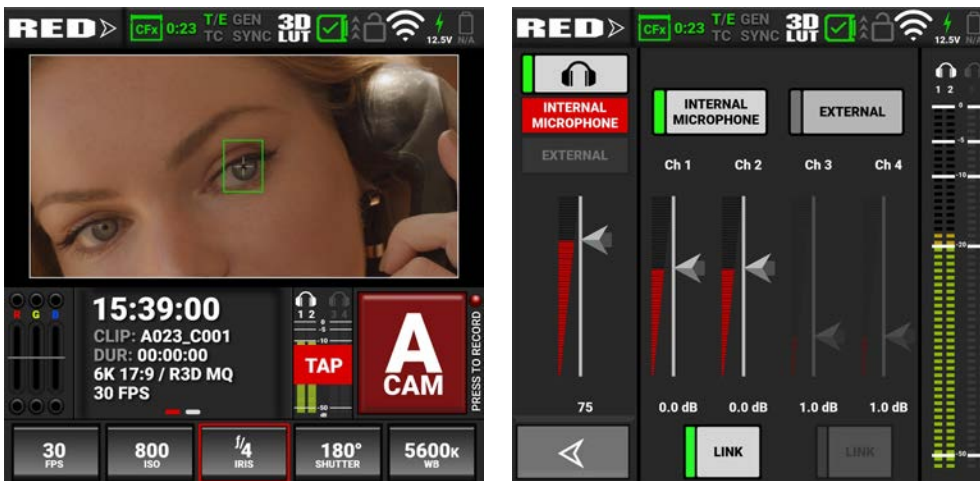

Return to the LCD home page by tapping the arrow .

The Audio tools provide an easy way to control many of the audio features. When the features are selected, the buttons indicate the selection.

HEADPHONE

The headphone section allows you to enable/disable the headphone output, to select input from Internal Microphone, or External, and to adjust the headphone volume with a slider.



AUDIO SOURCE

The Audio Source section allows you to select the audio source the camera will record to the clip. You can select Internal Microphone, External, both, or none. Use the sliders to adjust the gain for each channel. You can use the Link button to link channels 1 and 2, or to link channels 3 and 4. This allows you to adjust both of the internal or external channels together.



AUDIO VU METER

The Audio VU Meter section displays the audio input received by the camera from the four channels.



As the input increases, the level indicator changes from green to yellow to orange to red. When the audio input clips, the channel number at the top of the VU meter turns red:

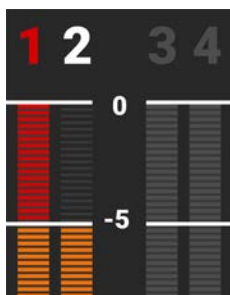

PLAYBACK

When you press on the Playback button, the Onboard LCD Touchscreen displays the Playback screen.

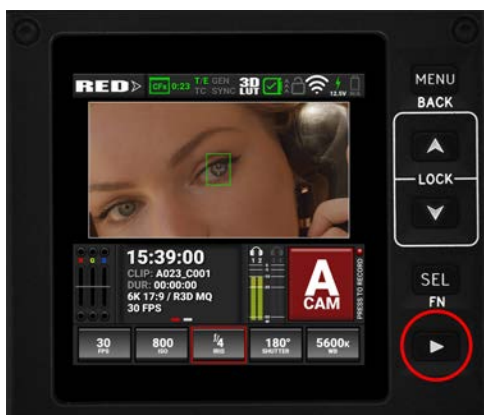

To close the Playback screen, press the Playback button.

NOTE: When you open playback, it disables many of the menu settings.

PLAYBACK SCREEN



The Playback screen displays the clip image along with the following:

- Clip Slider
- RGB Exposure
- Histogram
- Audio VU Meters
- Clip Information
- Playback Screen Buttons

CLIP SLIDER

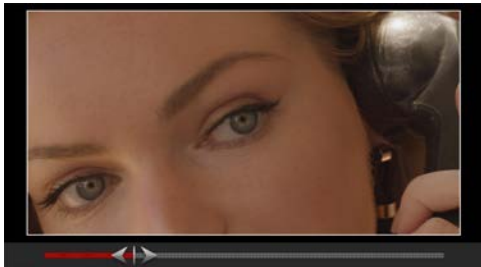

Use your finger to move forward and backward through the frames by swiping the image to the left and the right. The Clip Slider shows where in the timeline the displayed frame is located in the clip.

RGB EXPOSURE

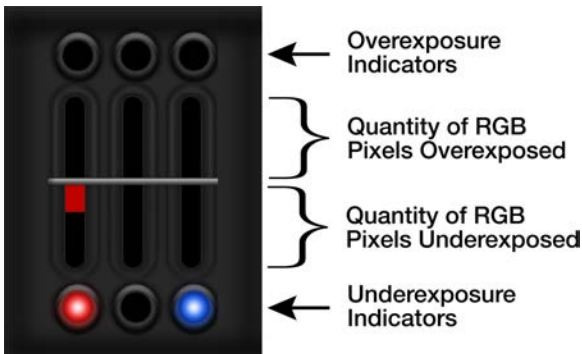

RGB Exposure displays the exposure levels of the separate RGB channels and indicates when a channel is underexposed or overexposed. This meter measures the raw image data regardless of the ISO and LUT settings.

HISTOGRAM

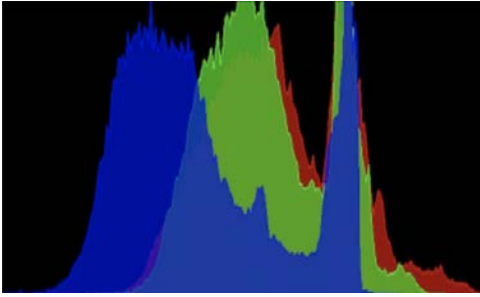

The histogram displays the darkest image elements at the far left, the midtones in the middle, and the lightest image elements at the far right. This gives you a quick way to view your overall image exposure levels.

AUDIO VU METERS

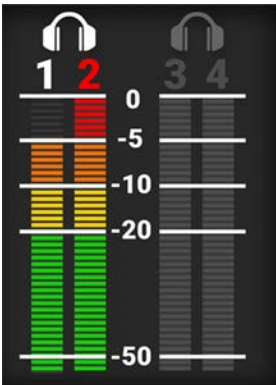

The Audio VU meters display the audio levels in the played clip.

CLIP INFORMATION

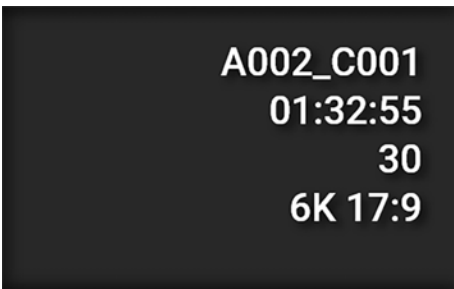

The Clip Information displays the name, duration, time base, and format of the clip.

PLAYBACK SCREEN BUTTONS



With the Playback screen buttons you can view the Clip list, move one clip back, move one frame back, play/pause, move one frame forward, and move one clip forward.

CLIP LIST

The Clip List button displays the list of clips recorded on the media card.

Each clip displays the first frame of the clip, the clip information, and the clip file format.

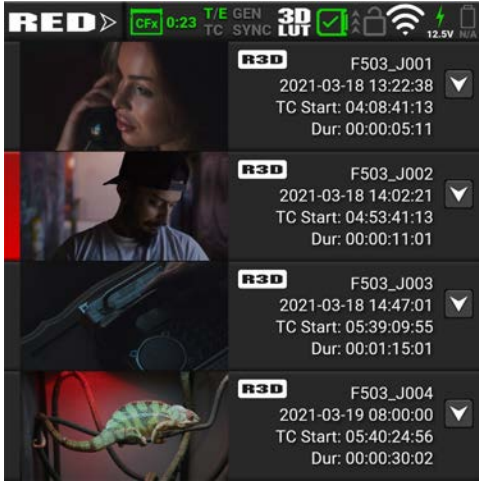

Swipe up and down to scroll through the list of clips. Tap the down arrow to open the clip information screen.

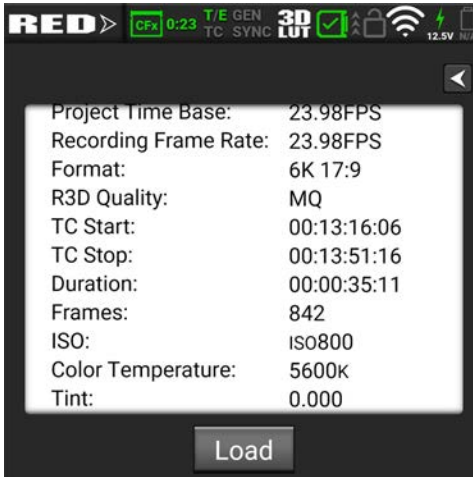
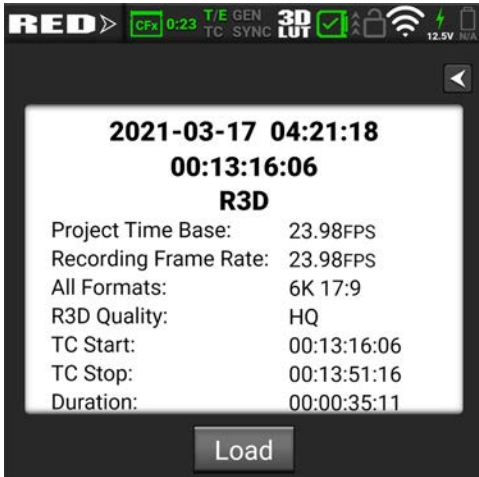

When you tap the Load button, the camera loads the clip to the Playback screen.

4. MENUS

This section describes the menus and sub-menus for the camera. To access the menus, navigate to a menu item from the **Onboard LCD Touchscreen**.

MENUS	DETAILS
Image / LUT Menu	ISO, Shutter, White Balance, Output Color Space, Output Tone Map, Highlight Roll-Off, Display Preset, 3D LUT, CDL, Exposure Adjust
Project Settings Menu	Format, Recording Frame Rate, Project Time Base, File Format, R3D Quality, ProRes Resolution, ProRes Codec, ProRes Color Profile, Pre-Record, Recording Mode, Timelapse, Frame Limit, Slate
Audio / TC Menu	Audio Source, Internal Mic, External Audio, Headphone, Timecode Source, Auto-Jam Toggle, Jam Timecode to TOD, Manual Timecode, Timecode Display Mode
Monitoring Menu	Onboard LCD, Top LCD, SDI, Live Stream, Tools, Guides
Media Menu	Eject, Media Info, Secure Format
User Settings Menu	Create Presets and assign User Button functions
Autofocus Menu	Enable AF, Mode, Size, Position, AF Toggle
Communication Menu	Camera, Connections (USB-C, Wi-Fi, Serial), Clients & Services (FTPS, PTP), Cloud Upload (Frame.io, AWS S3)
System Settings Menu	Date / Time, Licenses, Lens, Power, Sensor, Indicators, GPO, Status Settings, System Status
Language Menu	English, Chinese, French, German, Japanese, Spanish
Maintenance Menu	Calibrate, Calibration, Save Log, Reset Defaults, Factory Reset, Upgrade FW

IMAGE / LUT MENU

The Image / LUT menu contains the settings you use to configure your image.

From the Onboard LCD touchscreen menu, tap Image / LUT:

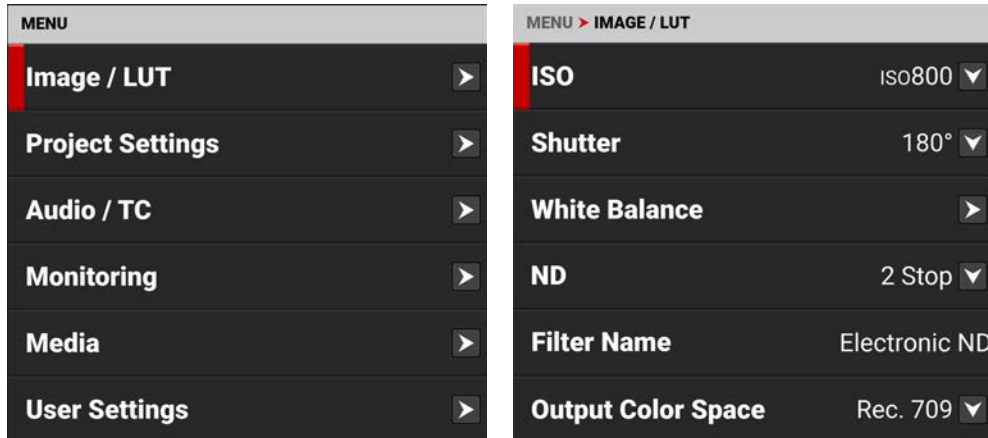

Use the Image / LUT menu to configure the camera's image and lookup table (LUT) settings:

ITEM	DETAILS
ISO	Adjusts the image's brightness in the monitoring path
Shutter	Adjusts the amount of time the sensor is exposed to light
White Balance	Adjusts the colors to compensate for the light source temperature
ND	When attached, you can adjust the ND value for the RF to PL Adapter w/ Electronic ND
Filter Name	When attached, this displays the name of the PL filter.
Output Color Space	Adjusts on-set working color space
Output Tone Map	Adjusts the image contrast
Highlight Roll-Off	Adjusts image highlight compression
Display Preset	Select the displayed preview image gamma for the SDI port
3D LUT	Manage the camera's look up tables (LUTs).
CDL	Opens the Color Decision List (CDL) menu
Exposure Adjust	Manually fine-tunes the midtone exposure level

ISO

Use the ISO setting to adjust the image's exposure in the monitoring path.

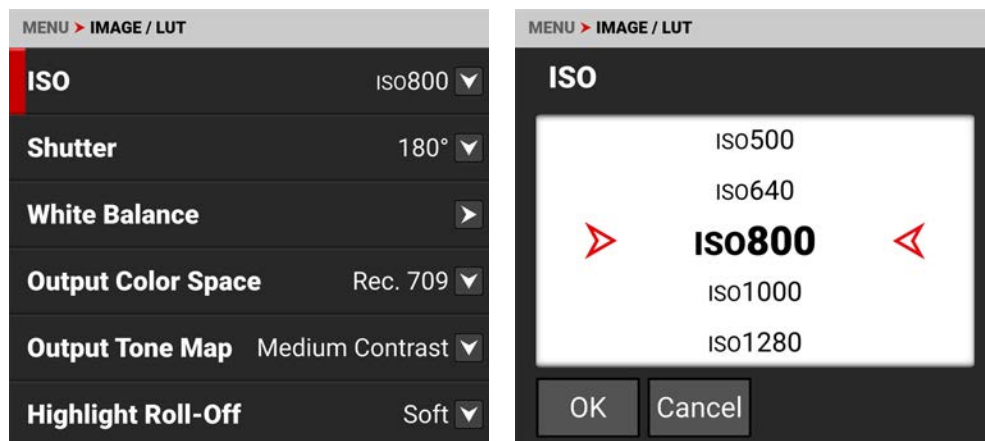

The ISO range is ISO 250 to ISO 12,800. The default ISO is ISO 800 for color and ISO 2000 for Monochrome.

Higher ISO values create brighter images in the monitor path, and lower ISO values create darker images in the monitor path.

When you record, the ISO settings are stored as metadata and you can adjust them non-destructively in post-processing with REDCINE-X PRO or other editing tools that support R3D files.

RED recommends setting the ISO to the default of 800, then adjusting the aperture and lighting to match. You can adjust the ISO later for fine-tuning.

NOTE: When you set the File Format to ProRes, the ISO is baked-in the image.

SHUTTER

Use Shutter to select the exposure time (shutter speed / shutter angle). The camera allows you to change the shutter settings while recording.

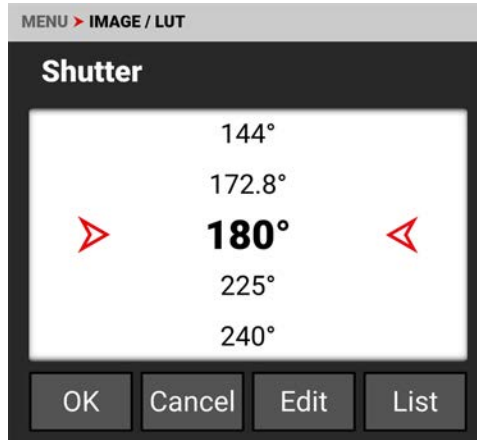
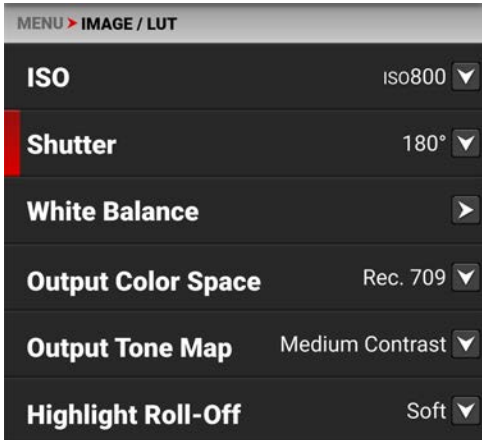

You can switch between Angle and Time settings by holding down the Onboard LCD Shutter quick setting button on the main menu, or by changing the Shutter Display mode in the **Status Settings** menu.

You can tap Edit to change the Shutter menu values manually.

You can tap List to choose which values you want to display on the menu list.

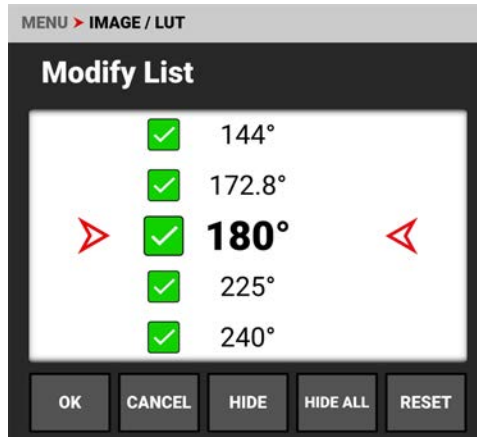
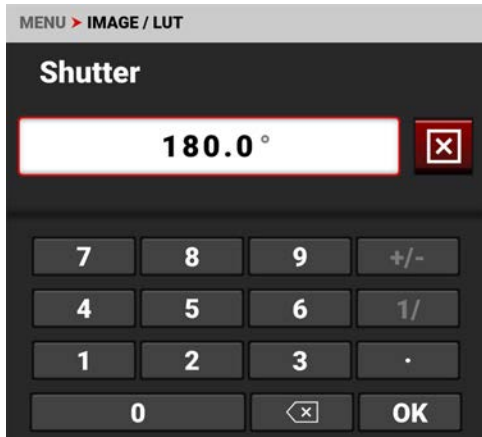

SHUTTER ANGLE

Enter the exposure value as a shutter angle (xx°). The shutter angle range is 1° to 360°. The default shutter angle is 180°. Click Edit to enter an exact shutter angle or shutter speed.

EXPOSURE CONVERSIONS

The table below lists common shutter angle and shutter speed equivalents. The calculations in the table use a recording frame rate of 23.98 fps.

SHUTTER ANGLE (°)	SHUTTER SPEED (1/XX SEC)	SHUTTER ANGLE (°)	SHUTTER SPEED (1/XX SEC)
360°	1/23.98	105°	1/82.20
288°	1/29.97	90°	1/95.90
270°	1/31.97	72°	1/119.88
240°	1/35.96	45°	1/191.81
225°	1/38.36	22.5°	1/383.62
180°	1/47.95	11.2°	1/770.66
172.8°	1/49.95	8.6°	1/1003.65
144°	1/59.94	4°	1/2157.84
135°	1/63.95	1°	1/8000 (max)
120°	1/71.93		

SHUTTER SPEED

Enter the exposure value as a shutter speed (1/xx sec).

The slowest shutter speed is 1/(recording frame rate). For example, if the recording frame rate is 23.98 fps, the slowest available shutter speed is 1/23.98 sec. The slowest available shutter speed in the camera is 1/5.99 sec when the recording frame rate is set to 5.99 fps. The fastest shutter speed is 1/8000 sec. The default shutter speed is 1/47.95 sec.

CONVERT SHUTTER SPEED TO SHUTTER ANGLE

Shutter Angle = (Shutter Speed x Frame Rate x 360)

Example: $(1/47.95 \times 23.98 \times 360) = 180$

CONVERT SHUTTER ANGLE TO SHUTTER SPEED

Shutter Speed = $1 / (\text{Frame Rate} \times 360 / \text{Angle})$

Example: $1 / (23.98 \times 360 / 180) = 1/47.95$

WHITE BALANCE

Use the White Balance menu to adjust the **Color Temperature**, **Color Temperature Presets**, **Tint** and execute the **Auto White Balance**.

NOTE: Color temperature is disabled on Monochrome cameras.

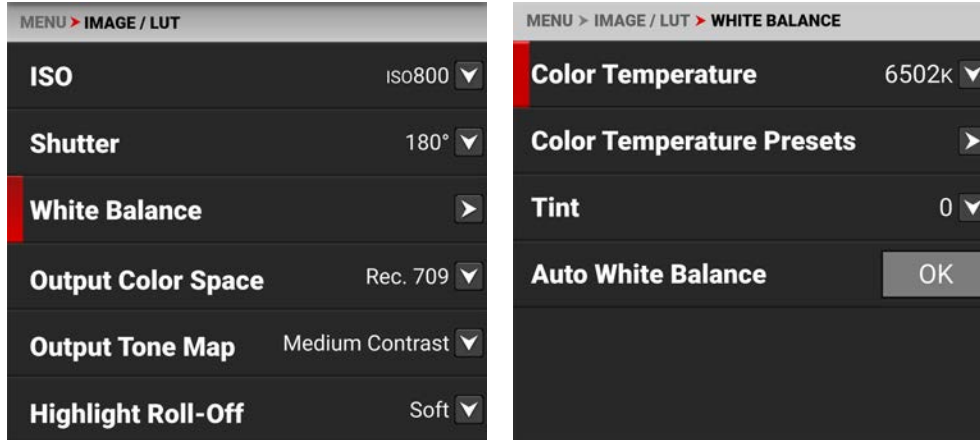

You can switch between Kelvin and Presets by holding down the Onboard LCD WB quick setting button on the main menu, or by changing the White Balance List mode in the **Status Settings** menu.

When shooting in R3D format, the camera stores white balance as metadata, which you can adjust non-destructively in post-production after filming.

Use the White Balance menu to configure the color temperature and tint settings for your image:

ITEMS	DETAILS
Color Temperature	Image color temperature correction
Color Temperature Presets	Tap a button to select a preset color temperature
Tint	Adjust magenta-green color component
Auto White Balance	The camera automatically sets the color temperature and tint

NOTE: When you set the File Format to ProRes, White Balance is baked-in the image.

COLOR TEMPERATURE

Use Color Temperature to adjust the image's color temperature in Kelvin units (K) or by selecting presets.

NOTE: Color temperature is disabled on Monochrome cameras.

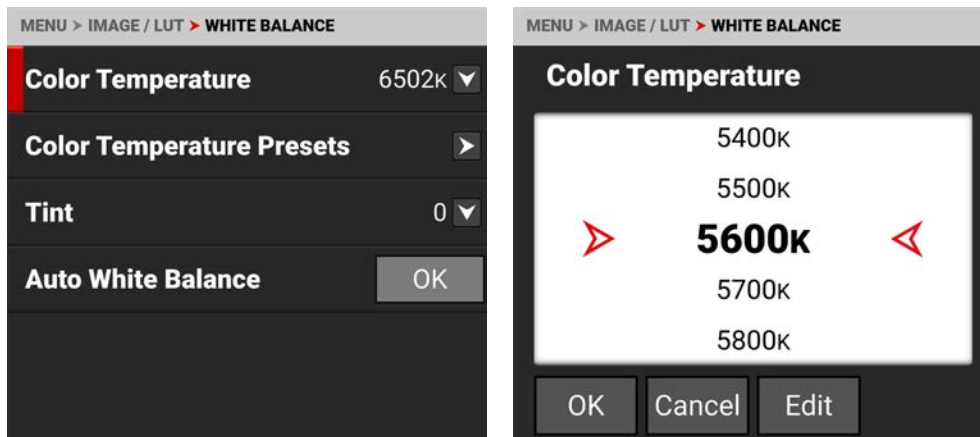

When the image's light source color temperature is warm, you can compensate by setting the camera to a warmer color temperature. When the image's light source color temperature is cool, you can compensate by setting the camera to a cooler temperature.

The color temperature range is 1,700 K to 10,000 K. The default color temperature is 5600 K.

When the White Balance List Mode (refer to [Status Settings](#)) is set to Presets, the Color Temperature menu list uses the preset temperatures instead of the Kelvin temperatures.

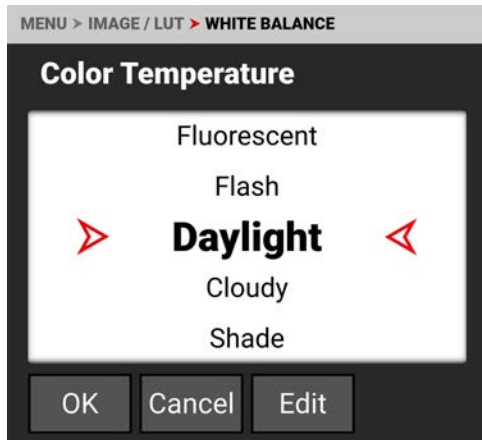

COLOR TEMPERATURE PRESETS

Use Color Temperature Presets to select a pre-configured color temperature.

NOTE: Color temperature is disabled on Monochrome cameras.

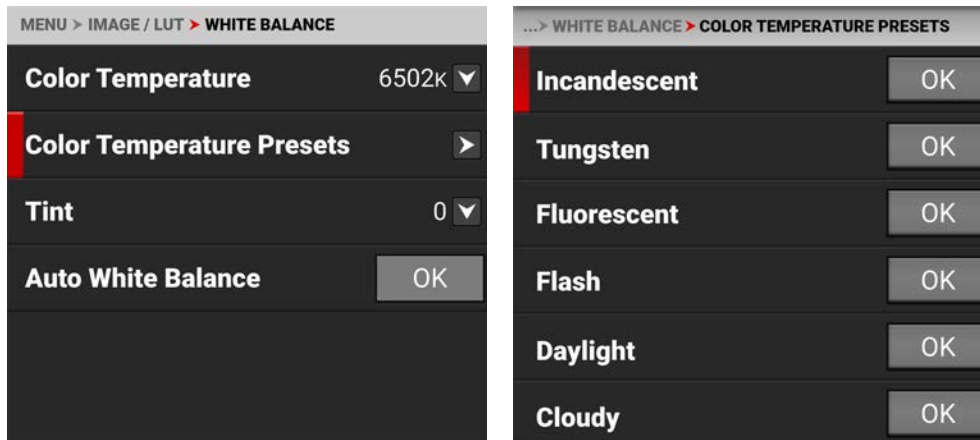

The color temperature presets you can select include:

ITEMS	DETAILS	ITEMS	DETAILS
Incandescent	2800 K	Daylight	5600 K
Tungsten	3200 K	Cloudy	7500 K
Fluorescent	4500 K	Shade	9000 K
Flash	5500 K		

TINT

Use Tint to adjust the image's color tint.

NOTE: Tint is disabled on Monochrome cameras.

Color temperature calculations assume a pure light source that may not be true in the specific scene the camera is imaging. To compensate for any residual colorcast, the Tint setting adjusts the RGB color balance with a compensating magenta-green color component.

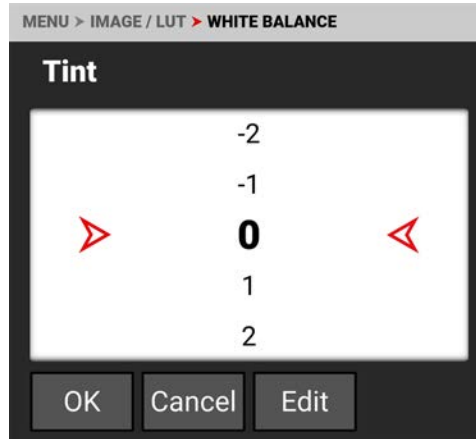
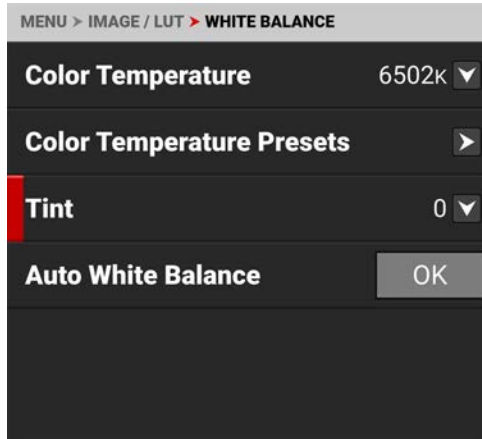

Tint range is -100 to 100. The default Tint setting is 0.

Use Edit to open the keypad screen where you can enter a specific Tint value.

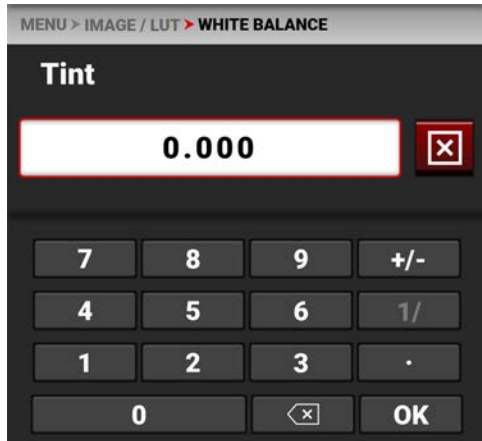

AUTO WHITE BALANCE

Use Auto White Balance to use the camera's automatic white balance adjustment.

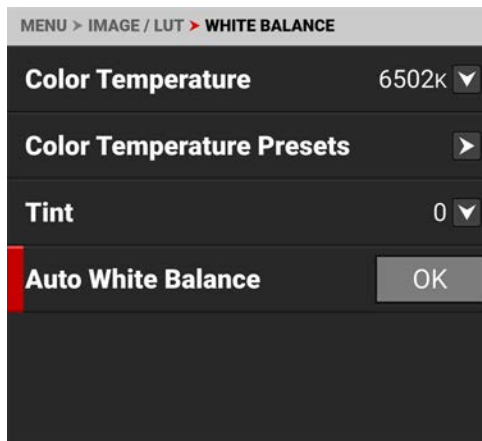

When shooting in R3D format, the camera stores white balance as metadata, which you can adjust non-destructively in post-production after filming.

To use Auto White Balance:

1. Place an 18% gray chart in the center of the image under the correct exposure.
2. From the **White Balance** menu tap OK next to **Auto White Balance**.
3. The camera automatically sets the color temperature and tint settings.

NOTE: Place the chart in the same location as your subject, and illuminate it with the same lighting. Make sure that you center the chart, and that it fills at least 25% of the sensor area.

ND

When the RF to PL Adapter w/ Electronic ND is attached, and the Electronic ND filter is inserted, you can use this menu to select the density of the ND filter.

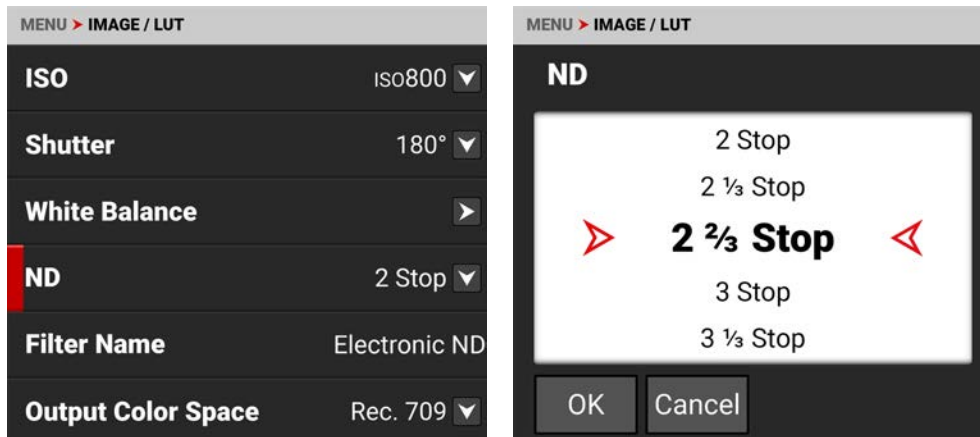

The ND filter range is 2-7 stops or 0.6 to 2.1 density. From the Status Settings menu, you can use the ND Display Mode submenu to select Stops or Density units, and you can use the ND Increments submenu to select the size of the ND increments displayed on the camera (refer to [Status Settings](#) for more information).

OUTPUT COLOR SPACE

Use Output Color Space to select the desired color space associated with the clip. When the camera file format is R3D, it saves this color space as metadata, which you can adjust in post-processing. When the camera uses the ProRes file format, and the ProRes Color Profile is Image/LUT, the camera bakes the color space in the resulting image.

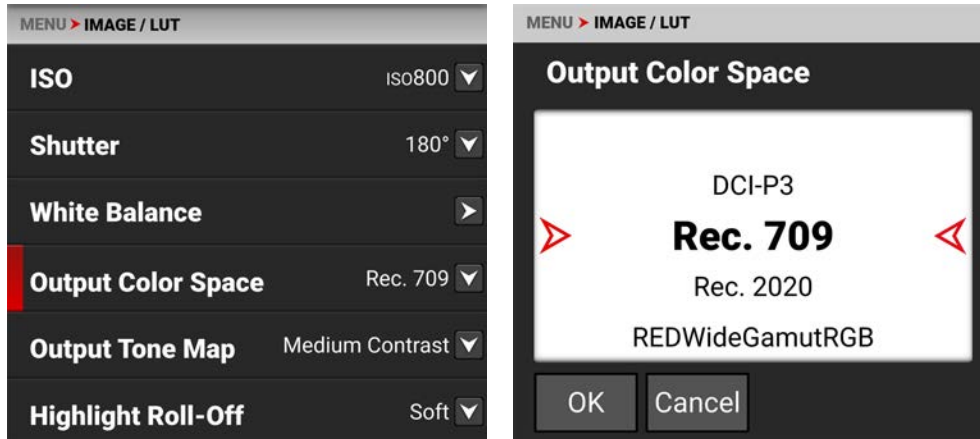

The Output Color Space selections include:

- DCI-P3 - Digital Cinema Initiatives theater projector standard color space
- Rec. 709 - Standard Color Space for HDTV (default)
- Rec. 2020 - Standard Color Space for UHD and HDR
- REDWideGamutRGB - Color space encompassing all of the colors the RED camera can generate without clipping.

OUTPUT TONE MAP

Use Output Tone Map to adjust the image contrast when displaying the camera output.

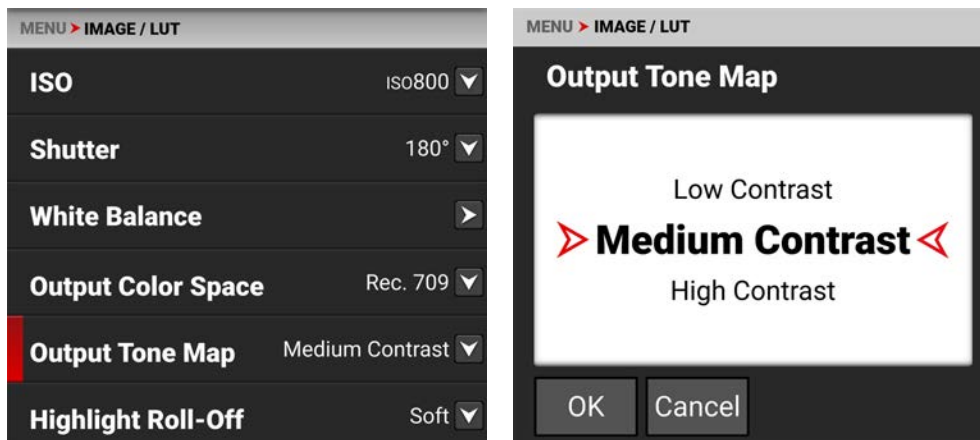

When shooting in R3D format, the camera stores this as metadata, which you can adjust non-destructively in post-production after filming.

The Output Tone Map selections include:

- Low Contrast - Low contrast is applied to the image
- Medium Contrast - Medium contrast is applied to the image (default)
- High Contrast - High contrast is applied to the image.

HIGHLIGHT ROLL-OFF

Use Highlight Roll-Off to select the desired highlight compression to use when displaying the camera output.

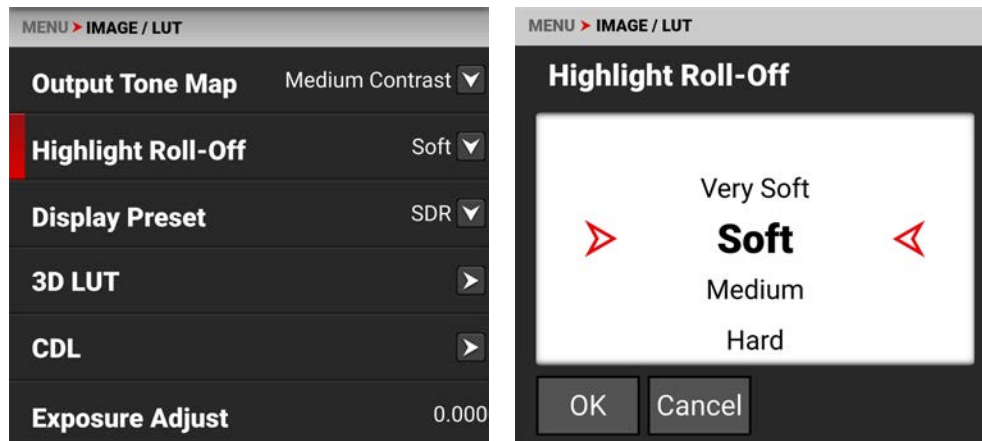

When shooting in R3D format, the camera stores this as metadata, which you can adjust non-destructively in post-production after filming.

The Highlight Roll-Off selections include:

- Very Soft - The lightest compression is applied to the image highlights
- Soft - Soft compression is applied to the image highlights (default)
- Medium - Medium compression is applied to the image highlights
- Hard - The highest compression is applied to the image highlights.

DISPLAY PRESET

Use Display Preset to select the gamma of the displayed preview image for the SDI port:

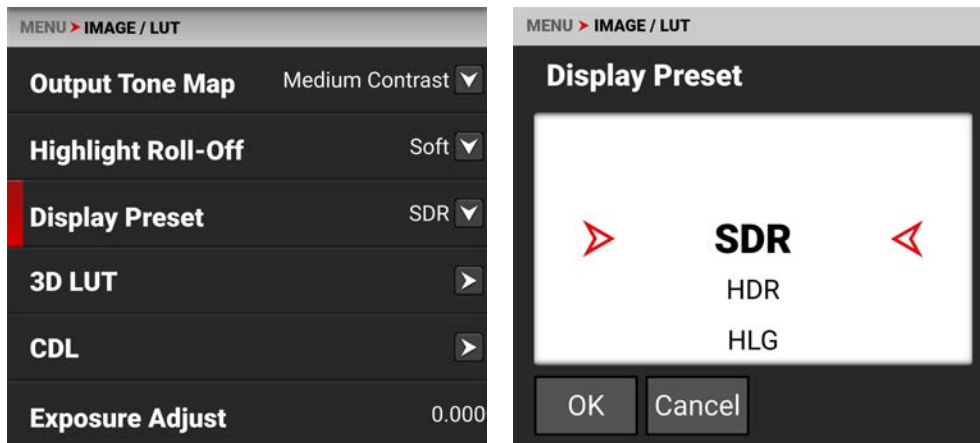

When shooting in R3D format, the camera stores this as metadata, which you can adjust non-destructively in post-production after filming.

The Display Preset allows you to select the gamma for the camera preview and monitor output.

Each monitor is designed to display using a specific gamma. Most monitors use SDR. However, some support HDR and HLG gamma signals. Select the display preset that works best with your monitor.

The selections are:

- SDR - Standard Dynamic Range (default)
- HDR - High Dynamic Range
- HLG - Hybrid Log-Gamma

Standard-dynamic-range (SDR) video describes images or video using a conventional gamma curve signal.

High-dynamic-range (HDR) video images are recorded using the SMPTE-2084 PQ curve. This technology captures and outputs a greater range of luminance than images recorded using standard-dynamic-range (SDR) methods.

Hybrid log-gamma (HLG) delivers HDR resolution without the need for metadata. This allows HLG to display well on SDR and HDR monitors.

3D LUT

Use the 3D LUT menu to apply and manage the camera's Look-Up Tables (LUTs).

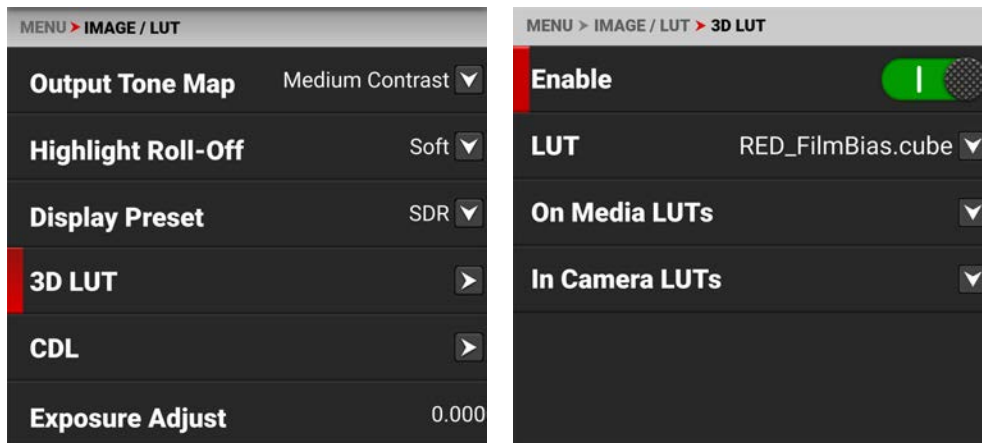

LUT

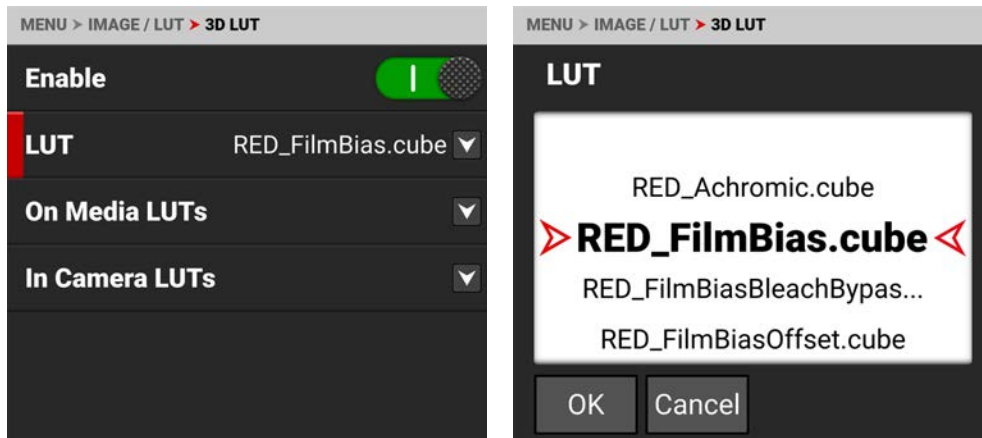

When you are recording in the ProRes format, you can choose to irreversibly encode (bake) the 3D LUT into the recorded file. For more information, refer to the [ProRes Color Profile](#) section.

When you are recording in the R3D format, this LUT will be saved along with each clip on which it is activated during recording. The output file name format for the LUT is `clip_LUT Name.cube`.

The LUT is non-destructive, and it is reversible, when recording in the R3D format.

To apply a 3D LUT, follow the instructions below:

1. Go to **MENU > IMAGE / LUT > 3D LUT > LUT**.
2. Select a LUT from the **LUT** list.

ON MEDIA LUTS

To import 3D LUTs from media, go to **MENU > IMAGE / LUT > 3D LUT > On Media LUTs**.

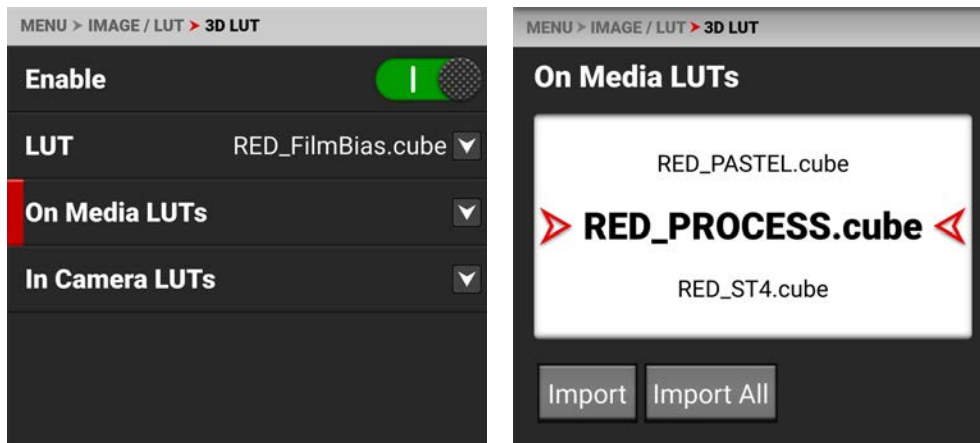

3D LUTs can be imported from media to the camera. When importing 3D LUTs from media to the camera, the 3D LUTs must be saved on the root path of your media, in a folder titled "luts." The camera only supports 33x33x33 LUTs.

From On Media LUTs, you can:

- Import the selected 3D LUT from the media to the camera
- Import all 3D LUTs from the media to the camera.

When you copy LUTs from a computer to the media, make sure that the card reader is not set to read only.

IN CAMERA LUTS

To export and delete 3D LUTs stored in the camera, go to **MENU > IMAGE / LUT > 3D LUT > In Camera LUTs**.

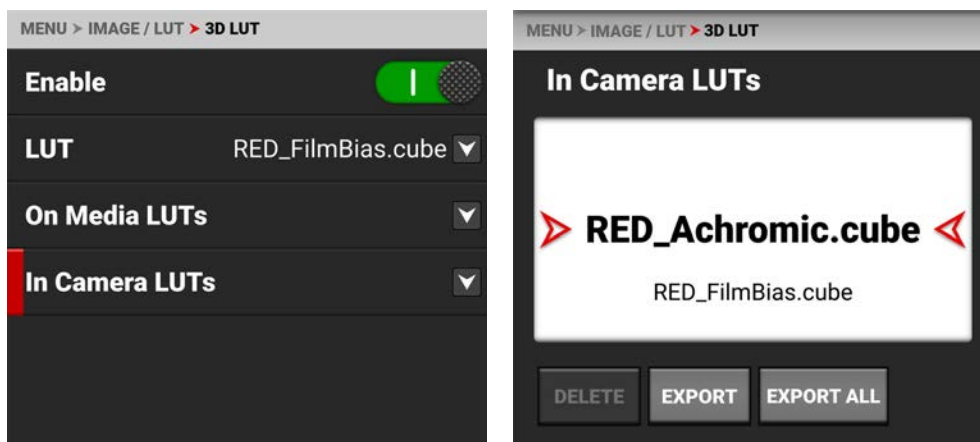

You can export 3D LUTs stored on the camera, to media, to use on other cameras. When you export 3D LUTs from the camera to media, the 3D LUTs are saved to a folder on the media called "luts."

NOTE: When a LUT is active during record, the camera will automatically save the LUT along with the recorded clip.

From In Camera LUTs you can:

- Delete a selected 3D LUT from the camera
- Export a selected 3D LUT from the camera to the media
- Export all 3D LUTs from the camera to the media.

CDL

The Color Decision List (CDL) allows you to define the look of the camera's colors in your project.

NOTE: The CDL menu is disabled on Monochrome cameras.

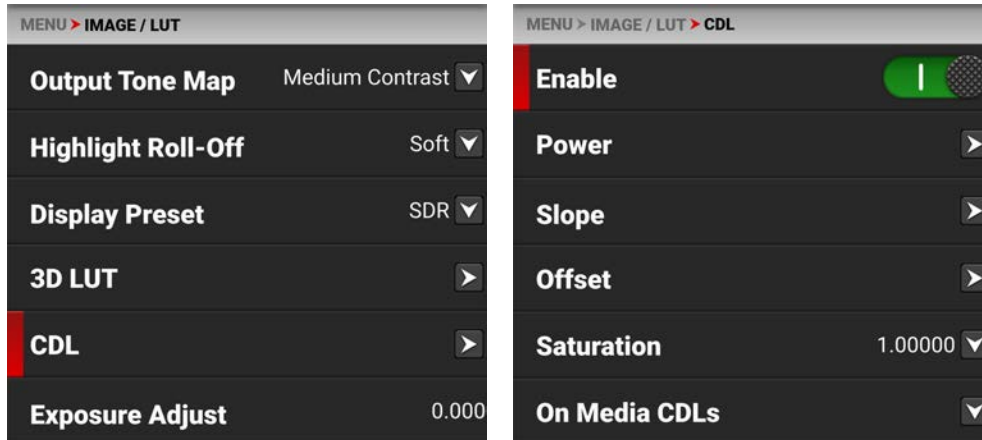

Use the CDL menu to:

- Enable the CDLs
- Configure **CDL Power**
- Configure **CDL Slope**
- Configure **CDL Offset**
- Configure **CDL Saturation**

MANAGE CDLS

Use the CDLs menu to import and export CDLs.

CDLs can be stored on the camera or transferred to media to be shared with other cameras. When exporting CDLs from camera to media, the CDLs are saved to a folder on the media called “cdls”. When importing CDLs from media to the camera, the CDLs must be stored on the media in a folder called “cdls.”

When you record with a CDL in ProRes format, the CDL is baked-in with the ProRes file. When you record with a CDL in R3D format, the camera automatically saves the CDL file along with the R3D files.

To export selected CDLs from the camera to the media, refer to the **In Camera CDLs** section.

To import selected CDLs from the media to the camera, refer to the **On Media CDL** section.

CDL OVERVIEW

A Color Decision List (CDL) is a metadata file format developed by the American Society of Cinematographers (ASC) to exchange standard color correction information between post production tools. This non-destructive color adjustment layer simplifies the versioning of looks by updating simple metadata without the need to re-transfer the image data.

CDLs are very common in VFX workflows because the VFX artist needs both the ungraded shot and the intended look. The ungraded shot allows the artist to comp in truly linear light, and the intended look is needed to confirm that the individual plates still hold together after the grade is applied.

SLOPE, OFFSET AND POWER

The three CDL tone curve parameters are Slope, Offset and Power. These algorithms allow the camera to modify the recorded image.

- Slope multiplies the incoming data
- Offset is sum of the incoming data
- Power is a power function to the incoming data

These three relate to Gain, Lift, and Gamma in the following ways:

- Slope = Gain
Gain Adjusts highlights.
- Offset = Lift
Lift Increases the value of dark colors.
- Power = Gamma
Gamma adjusts midtones.

These three relate to each other in the following ways:

Slope= input x slope

Offset= (input x slope) + offset

Power= ((input x slope) + offset) ^ power

The formula for ASC CDL color correction is:

$$out = ((i \times s) + o)^p$$

where

- out* is the color graded pixel code value
- i* is the input pixel code value (0=black, 1=white)
- s* is slope (any number 0 or greater, nominal value is 1.0)
- o* is offset (any number, nominal value is 0)
- p* is power (any number greater than 0, nominal value is 1.0)

The formula is applied to the three color values for each pixel using the corresponding slope, offset, and power numbers for each color channel.

SATURATION

A fourth parameter “Saturation” is achieved by converting the *out* data in a Luma and Chroma component. The Chroma Signal is then multiplied by the “Saturation” parameter.

FILM GRADE AND VIDEO GRADE

With Slope and Offset you can produce both a Film Grade “Exposure” and “Contrast” and a Video Grade “Lift” and “Gain.”

- Exposure is achieved by Offset
- Contrast is achieved by a combination of Offset and Slope
- Gain is achieved by Slope
- Lift is achieved by a combination of Offset and Slope
- Gamma is achieved by Power

CDL POWER

The CDL Power settings control the power of the Red, Green, and Blue, color data.

NOTE: The CDL options are disabled on Monochrome cameras.

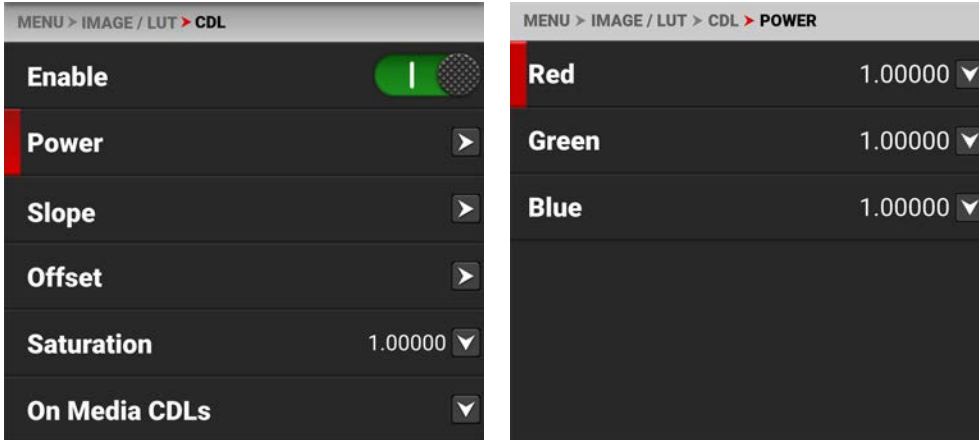

Use the CDL Power menu to adjust the power of the Red, Green, and Blue CDL data.

CDL POWER SETTINGS

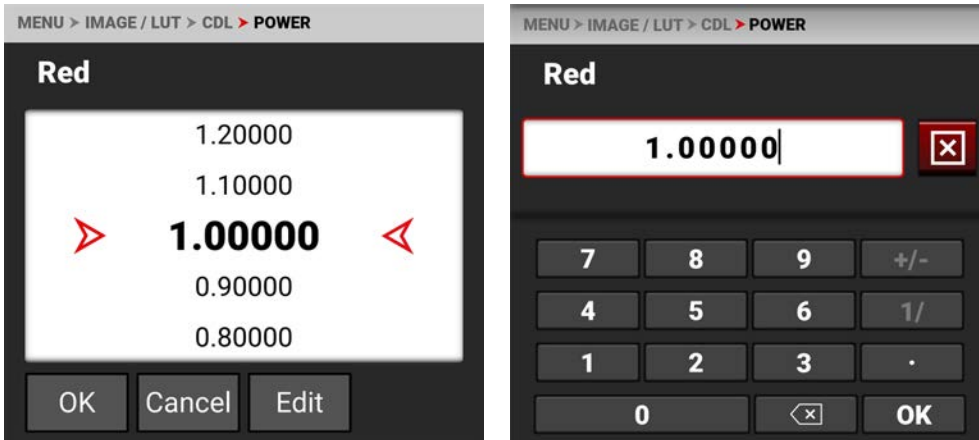

The CDL Power settings range from 0.00000 to 4.00000. The default CDL Power setting for each color is 1.00000. The Edit button opens the keypad where you can enter a specific CDL Power value.

CDL SLOPE

The CDL Slope settings multiply the incoming RGB data.

NOTE: The CDL options are disabled on Monochrome cameras.

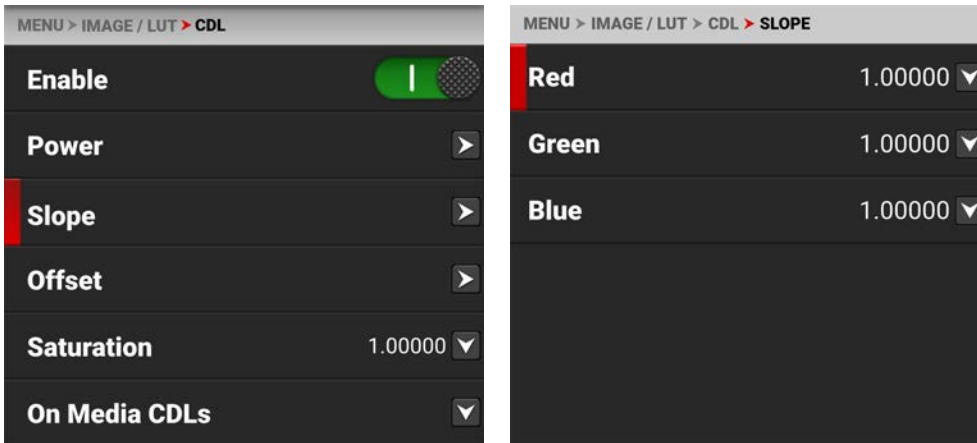

Use the CDL Slope menu to set the slope of the Red, Green, and Blue signals.

SLOPE SETTINGS

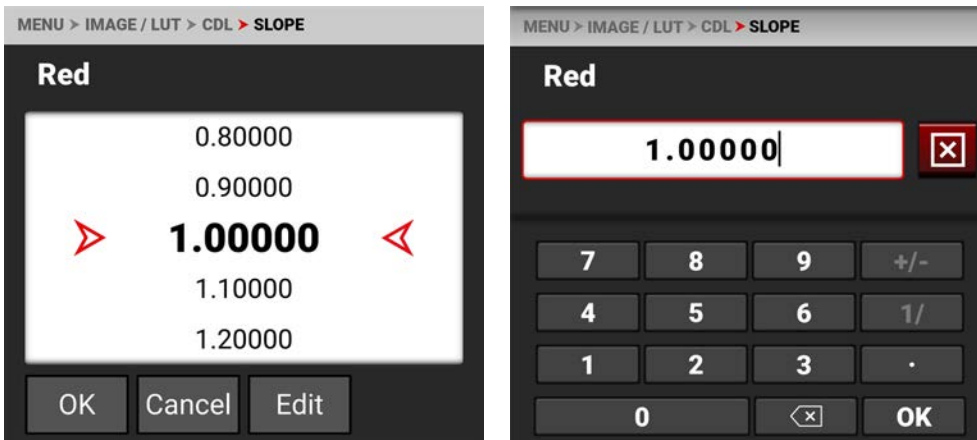

The CDL Slope settings range from 0.00000 to 2.00000. The default CDL Slope settings are 1.00000. The Edit button opens a keypad where you can enter a specific CDL Slope value.

CDL OFFSET

The CDL Offset settings control the offset of the RGB color data.

NOTE: The CDL options are disabled on Monochrome cameras.

The Camera LCD Menu for CDL Offset:

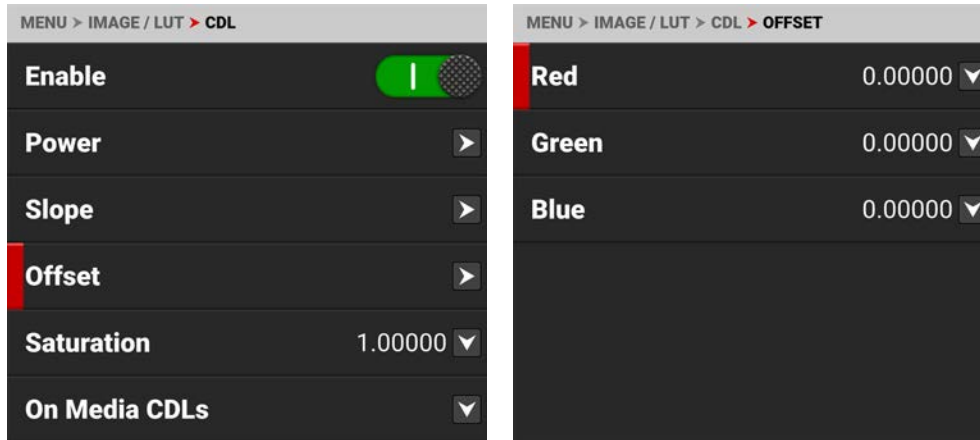

Use the CDL Offset menu to adjust the offset of the **CDL Slope** for the Red, Green, and Blue CDL data.

RED GREEN AND BLUE OFFSETS

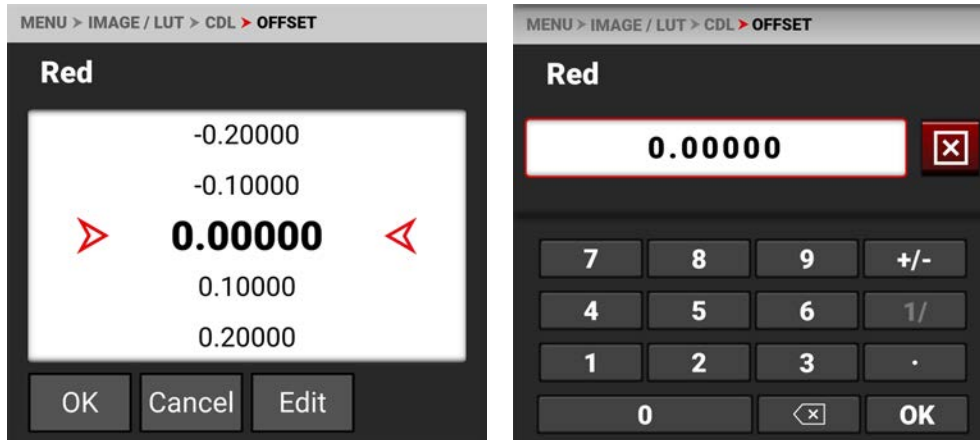

These CDL Offset settings range from -1.00000 to 1.00000. The default CDL Offset setting for each is 0.00000. The Edit button opens the keypad, where you can enter a specific CDL Offset value.

CDL SATURATION

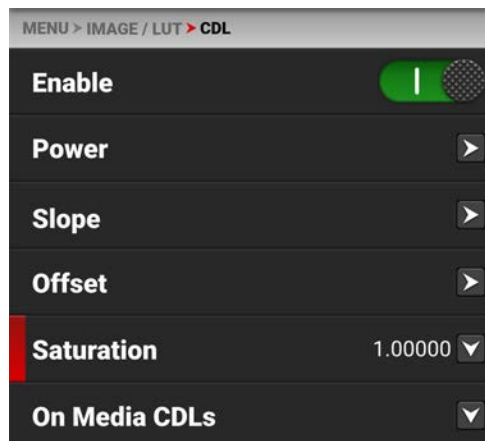

The CDL Saturation settings control the intensity of the color data.

NOTE: The CDL options are disabled on Monochrome cameras.
Use the CDL Saturation menu to adjust the intensity of the image color.

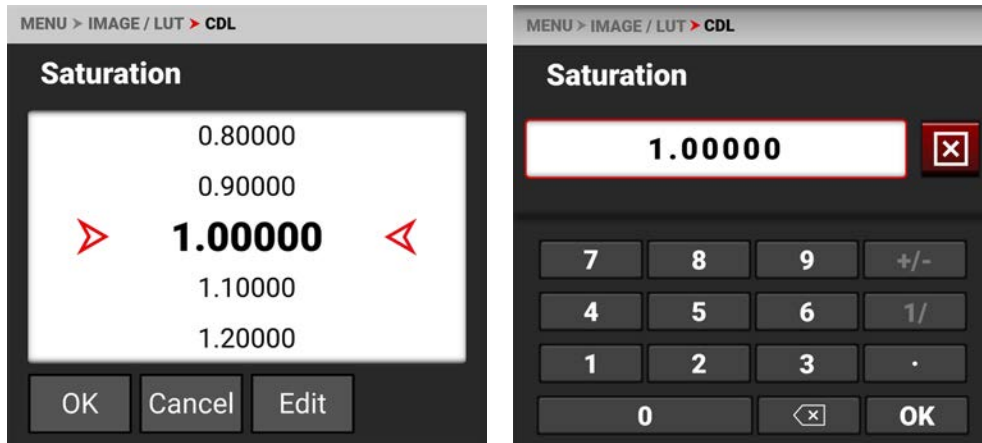

The CDL Saturation settings range from 0.00000 to 4.00000. The default CDL Saturation setting is 1.00000. The Edit button opens a keypad where you can enter a specific CDL Saturation value.

ON MEDIA CDL

Use On Media CDLs to import CDLs from the media to the camera.

NOTE: The CDL options are disabled on Monochrome cameras.

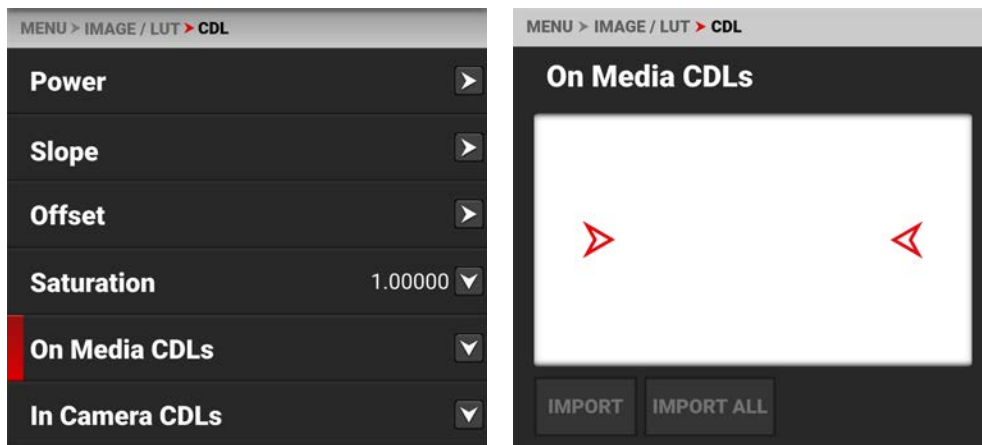

When importing CDLs from media to the camera, the CDLs are saved to a folder on the camera called “cdls”.

From On Media CDLs you can import a selected CDL from the media to the camera, or you can import all of the CDLs from the media to the camera.

When you copy CDLs from a computer to the media, make sure that the card reader is not set to Read Only.

IN CAMERA CDLS

Use In Camera CDLs to export CDLs from the camera to the media. You can also select which stored CDL you want to apply to the camera.

NOTE: The CDL options are disabled on Monochrome cameras.

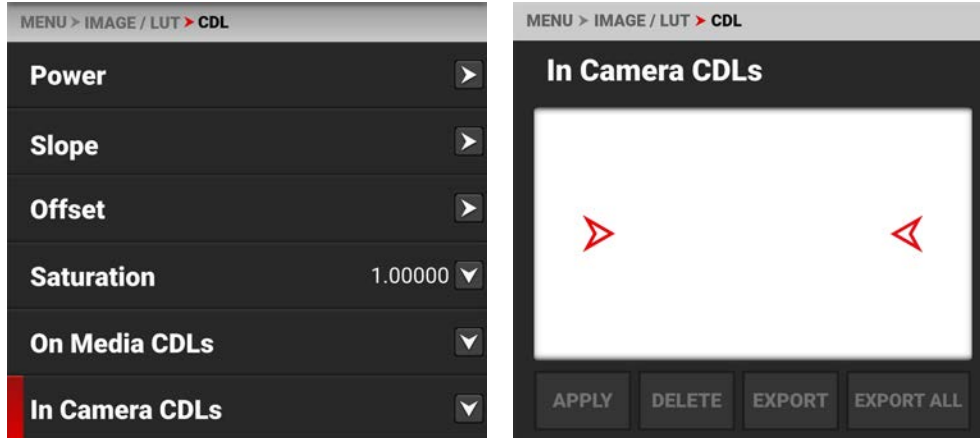

When exporting CDLs from the camera to the media, the CDLs are saved to a folder on the media called “cdls.”

From In Camera CDLs, you can apply the selected CDL to the camera, delete the selected CDL from the camera, export the selected CDL from the camera to the media, or export all of the CDLs from the camera to the media.

EXPOSURE ADJUST

Use Exposure Adjust to manually fine-tune the midtone exposure level.

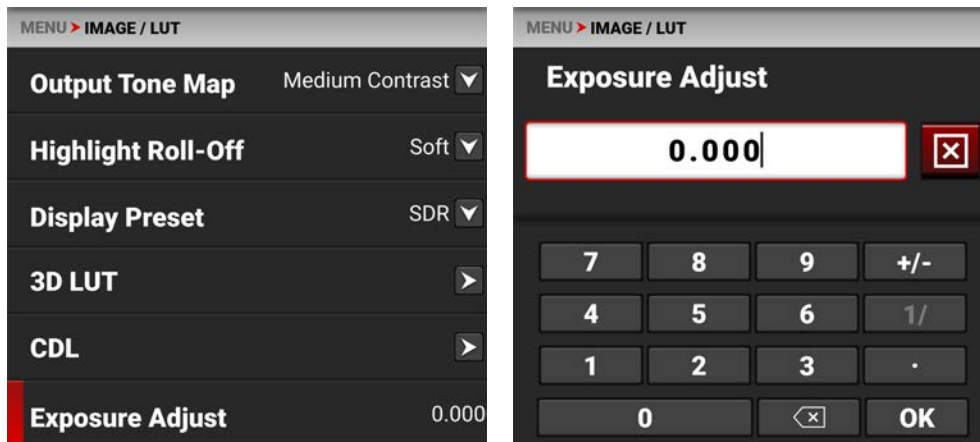

The Exposure Adjust range is –8.000 to 8.000. The default is 0.000.

Exposure Adjust allows you to adjust the midtone exposure levels while preserving the highlights and shadows, even when changed substantially. The Exposure Adjust setting is expressed in terms of relative exposure value (EV), where each unit represents a 1-stop change in midtone exposure level.

PROJECT SETTINGS MENU

The Project Settings menu contains the camera's main recording configuration settings.

From the Onboard LCD touchscreen menu, tap Project Settings:

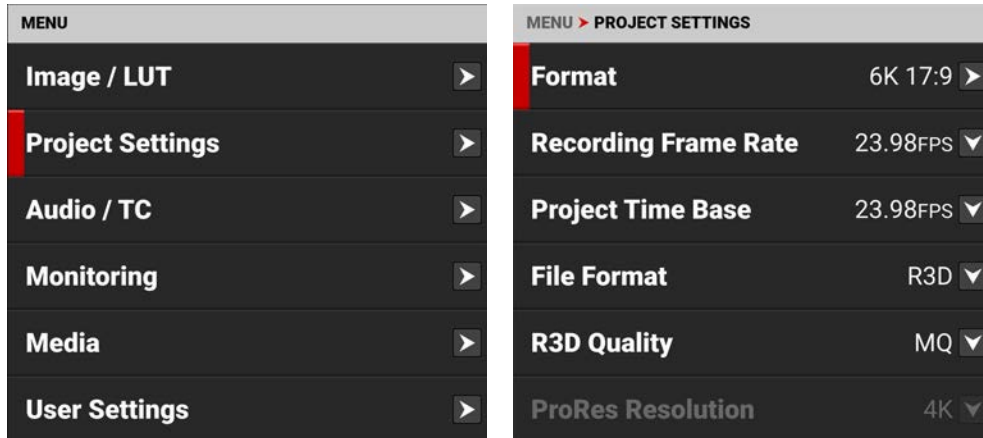

Use the Project Settings menu to configure the recording settings:

ITEMS	DETAILS
Format	Size of the area captured by the sensor
Recording Frame Rate	Frames recorded per second
Project Time Base	Image playback rate
File Format	R3D or ProRes file formats
R3D Quality	Compression level of the recorded image file
ProRes Resolution	Resolution of the recorded ProRes image file
ProRes Codec	ProRes codec selection
ProRes Color Profile	RWG / Log3G10 or Image / LUT settings
Pre-Record	Enable and configure a pre-record clip
Recording Mode	Select Motion or Timelapse mode
Timelapse	Interval Time and Frames per Interval
Frame Limit	Enable, Frames, and Playback Duration
Slate	Enter the Camera ID, Camera Position, Camera Operator, Scene, Shot, Take, Production, Director, DoP, and Unit

FORMAT

Use the Format setting to designate how much of the sensor the camera should use to capture images.

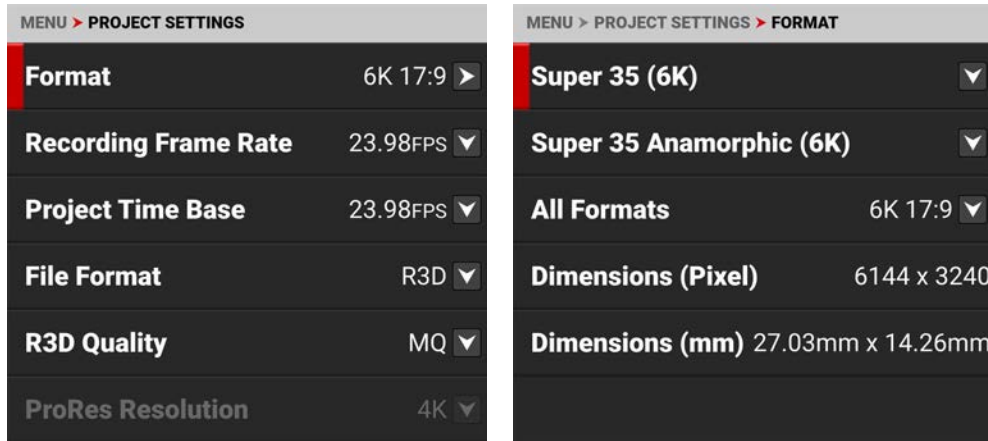

Use the Format menu to configure the camera's sensor capture area settings:

ITEMS	DETAILS
Super 35 (6K)	Select from Super 35 sensor capture areas
Super 35 Anamorphic (6K)	Select from Super 35 anamorphic sensor capture areas
All Formats	Select from all sensor capture areas
Dimensions (Pixel)	Displays the dimensions of the selected format in pixels
Dimensions (mm)	Displays the dimensions of the selected format in millimeters

The available aspect ratios are determined by the selected resolution. The default format setting is 6K 17:9.

When you lower the resolution in the Format menu, only a portion of the sensor is used. The camera does not downscale from the 6K 17:9 format when recording RAW.

SUPER 35 (6K)

Use the Super 35 (6K) format setting to designate how much of the sensor the camera should use to capture images.

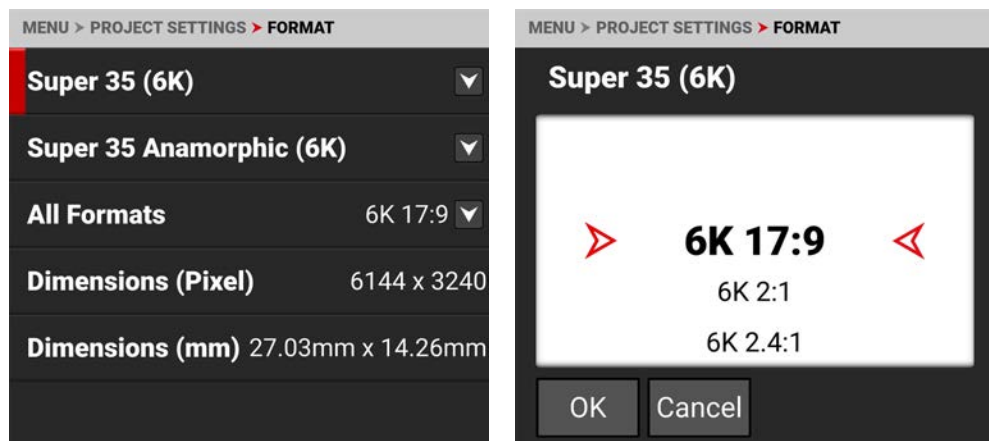

The available aspect ratios are determined by the selected resolution.

When you lower the resolution on the camera, only a portion of the sensor is used. The camera does not downscale from the 6K 17:9 format when recording RAW.

SUPER 35 (6K) FORMAT SPECIFICATIONS

This table contains the dimensions of the sensor area in Pixels and in Millimeters used by each Super 35 (6K) format. The default format is 6K 17:9.

FORMAT	DIMENSION (PIXELS)		DIMENSIONS (MM)		
	Width	Height	Width	Height	Diagonal
6K 17:9	6144	3240	27.03	14.26	30.56
6K 2:1	6144	3072	27.03	13.52	30.22
6K 2.4:1	6144	2592	27.03	11.40	29.34
6K 16:9	5760	3240	25.34	14.26	29.08
6K 1:1	3240	3240	14.26	14.26	20.17

SUPER 35 ANAMORPHIC (6K)

Use the Super 35 Anamorphic Format setting to designate how much of the sensor the camera should use to capture images.

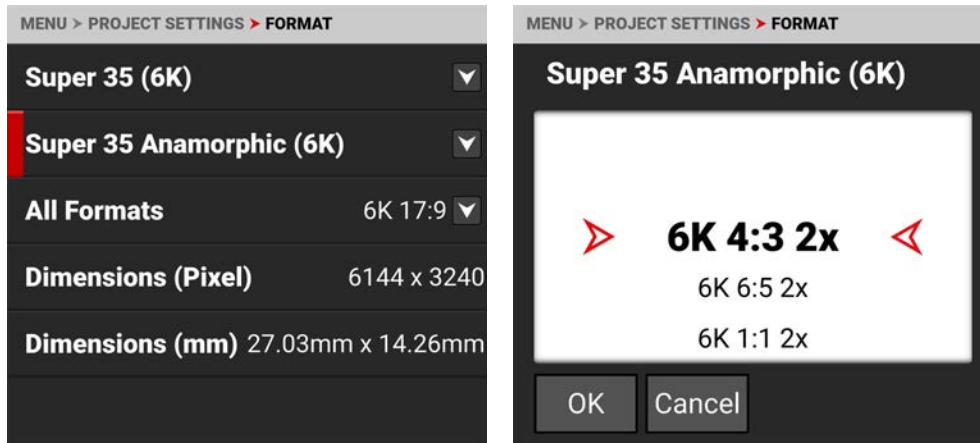

The available aspect ratios are determined by the selected resolution.

When you lower the resolution on the camera, only a portion of the sensor is used. The camera does not downscale from the 6K 17:9 format when recording RAW.

SUPER 35 ANAMORPHIC (6K) FORMAT SPECIFICATIONS

This table contains the effective dimensions of the sensor area in Pixels and in Millimeters used by each Super 35 Anamorphic (6K) format.

The default setting is 6K 4:3 2x.

FORMAT	DIMENSION (PIXELS)		DIMENSION DE-SQUEEZED (PIXELS)		DIMENSIONS (MM)		
	WIDTH	HEIGHT	WIDTH	HEIGHT	WIDTH	HEIGHT	DIAGONAL
6K 4:3 2x	4320	3240	8640	3240	19.01	14.26	23.76
6K 6:5 2x	3888	3240	7776	3240	17.11	14.26	22.27
6K 1:1 2x	3240	3240	6480	3240	14.26	14.26	20.17
6K 3:2 1.8x	4860	3240	8748	3240	21.38	14.26	25.70
6K 4:3 1.8x	4320	3240	7776	3240	19.01	14.26	23.76
6K 3:2 1.6x	4860	3240	7776	3240	21.38	14.26	25.70
6K 16:9 1.5x	5760	3240	8640	3240	25.34	14.26	29.08
6K 17:9 1.3x	6144	3240	8192	3240	27.03	14.26	30.56
6K 17:9 1.25x	6144	3240	7680	3240	27.03	14.26	30.56

ALL FORMATS

Use the All Formats setting to select from all of the possible formats to designate how much of the sensor the camera should use to capture images.

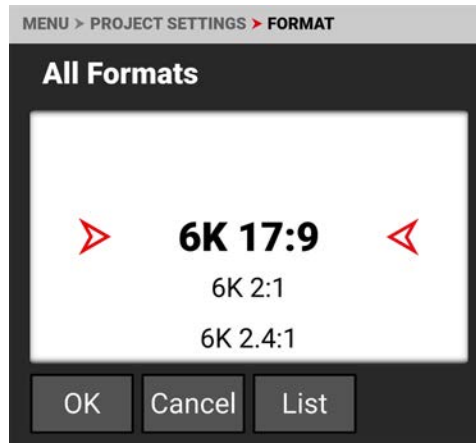
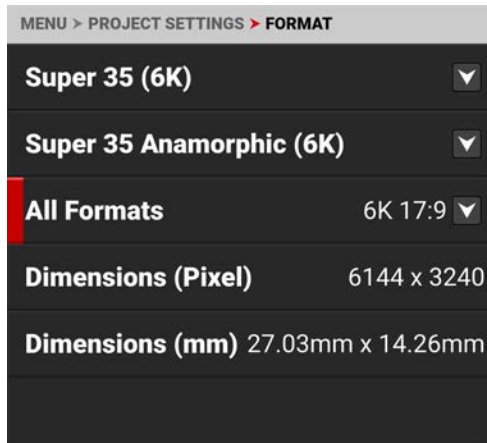

The available aspect ratios are determined by the selected resolution.

When you lower the resolution on the camera, only a portion of the sensor is used. The camera does not downscale from the 6K 17:9 format when recording RAW.

FORMAT SPECIFICATIONS

This table contains the dimensions of the sensor area in Pixels and in Millimeters used by all of the camera formats. The default setting is 6K 17:9.

FORMAT	DIMENSION (PIXELS)		DIMENSIONS (MM)		
	WIDTH	HEIGHT	WIDTH	HEIGHT	DIAGONAL
6K 17:9	6144	3240	27.03	14.26	30.56
6K 2:1	6144	3072	27.03	13.52	30.22
6K 2.4:1	6144	2592	27.03	11.40	29.34
6K 16:9	5760	3240	25.34	14.26	29.08
6K 1:1	3240	3240	14.26	14.26	20.17
6K 4:3 2x	4320	3240	19.01	14.26	23.76
6K 6:5 2x	3888	3240	17.11	14.26	22.27
6K 1:1 2x	3240	3240	14.26	14.26	20.17
6K 3:2 1.8x	4860	3240	21.38	14.26	25.70
6K 4:3 1.8x	4320	3240	19.01	14.26	23.76
6K 3:2 1.6x	4860	3240	21.38	14.26	25.70
6K 16:9 1.5x	5760	3240	25.34	14.26	29.08
6K 17:9 1.3x	6144	3240	27.03	14.26	30.56
6K 17:9 1.25x	6144	3240	27.03	14.26	30.56
5K 17:9	5120	2700	22.53	11.88	25.47
5K 16:9	4800	2700	21.12	11.88	24.23
4K 17:9	4096	2160	18.02	9.50	20.37
4K 16:9	3840	2160	16.90	9.50	19.39
2K 17:9	2048	1080	9.01	4.75	10.19

RECORDING FRAME RATE

Use Recording Frame Rate to select the recording frame rate (also referred to as the capture frame rate).

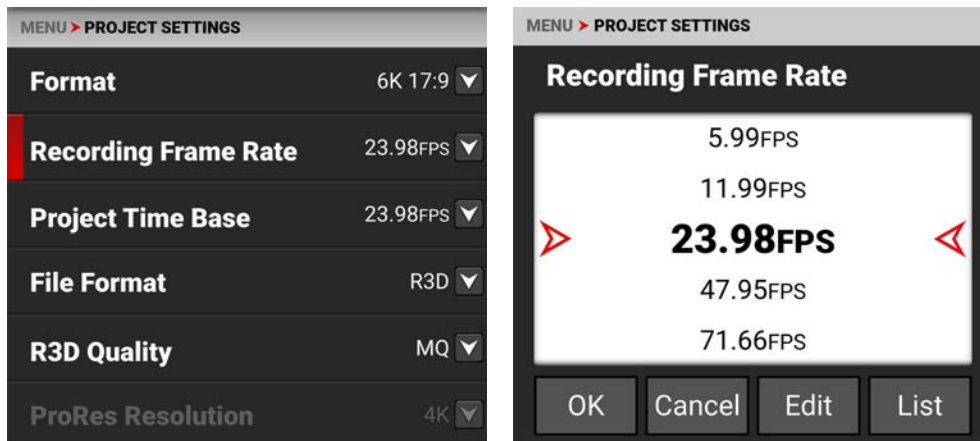

The recording frame rate is the number of frames per second (FPS) that are recorded. The recording frame rate is different from the project time base, which is the rate at which the footage will be played back. Lower values than the project time base will result in under-cranking (fast motion playback) and values larger than the project time base will result in over-cranking (slow motion playback).

You can tap **EDIT** to change the Recording Frame Rate menu values manually.

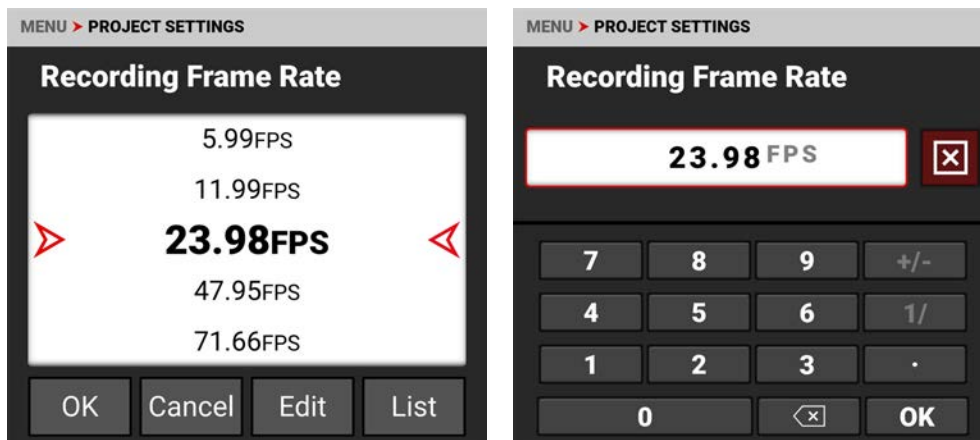

You can tap **LIST** to choose which values you want to display on the menu list.

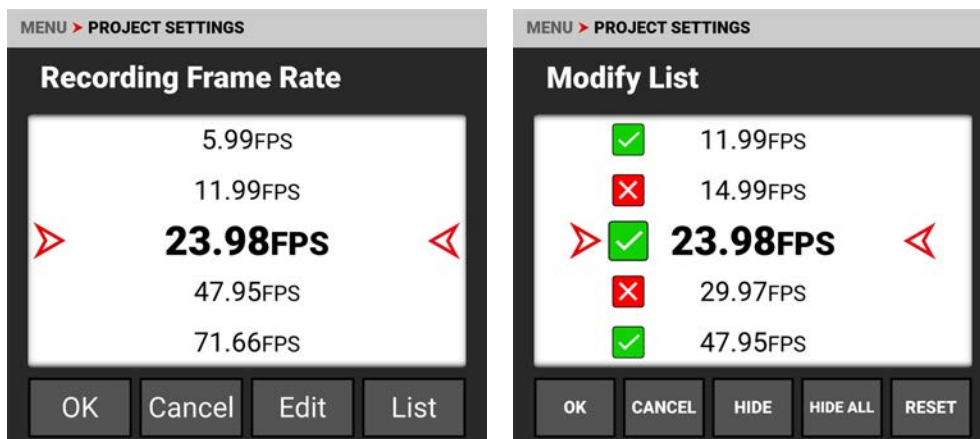

The maximum frame rate for each format is determined by **Project Time Base** and **Format**.

When you select a Project Time Base, the camera automatically selects a matching Recording Frame Rate and an R3D Quality (when possible). You must change the Recording Frame Rate and R3D Quality after the Project Time Base to select a different setting.

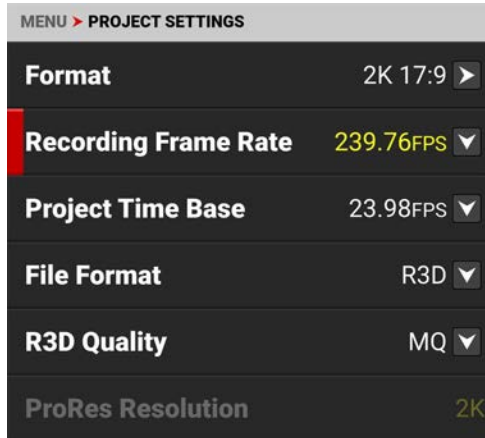

A Recording Frame Rate highlighted in **yellow** will result in playback occurring at a different frame rate than the original recording, and will record varispeed audio.

FORMATS AND FRAME RATES

This table lists the camera's maximum recording frame rates. These rates are based on a Project Time Base setting of 24 frames per second (24 FPS).

FORMAT	FPS
6K 17:9	80
6K 2:1	84
6K 2.4:1	100
6K 16:9	80
6K 1:1	80
5K 17:9	96
5K 16:9	96
4K 17:9	120
4K 16:9	120
2K 17:9	240

PROJECT TIME BASE

Use the Project Time Base setting to choose the playback rate for the recorded footage.

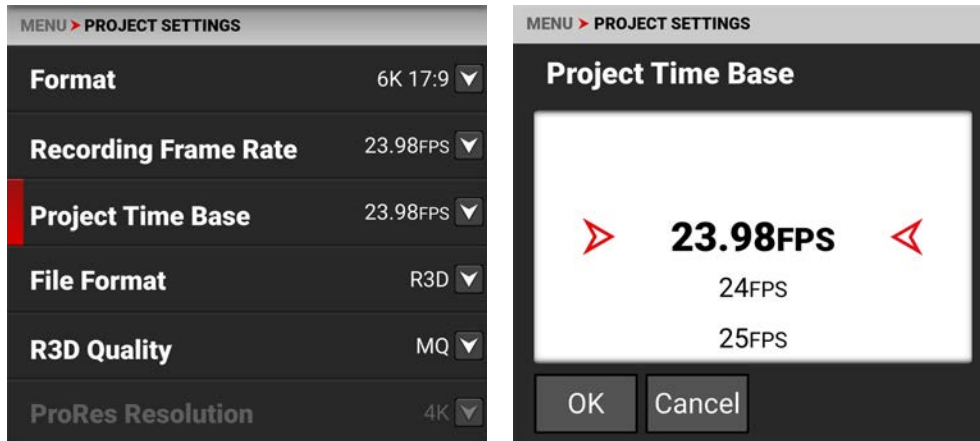

The following project time bases are available:

- 23.98 FPS (Default)
- 24.00 FPS
- 25.00 FPS
- 29.97 FPS
- 30.00 FPS
- 50.00 FPS
- 59.94 FPS
- 60.00 FPS

When you select the Project Time Base, it changes the Recording Frame Rate to the same setting (when possible).

When you change the Format, the Recording Frame Rate and Project Time Base do not automatically update. You must select the Project Time Base after you change the Format setting.

NOTE: When the Recording Frame Rate is set to a higher speed than the Project Time Base setting, audio is recorded as varisped audio (refer to [Audio / TC Menu](#)).

FILE FORMAT

Use File Format to select the format that the camera uses to record image files.

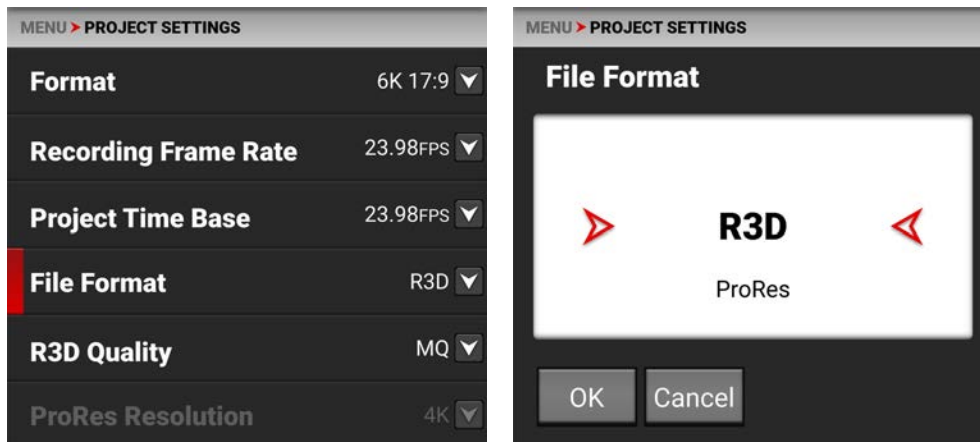

When you change the file format, a message warns you that the camera must be rebooted to complete the change:



R3D REDCODE FILE FORMAT

The RED R3D file format records images in a compressed RAW format. In comparison to Apple ProRes, REDCODE RAW data does not bake in image settings like ISO, saturation, or LUTs, allowing more flexibility in post-processing workflows without reducing image quality or dynamic range. Instead R3D files store the image settings as Metadata. You can open and process R3D files with REDCINE-X PRO or with non-linear editing (NLE) software that supports the RED SDK.

R3D is the camera's default file format.

APPLE PRORES FORMAT

This section provides general information about recording Apple ProRes files with the camera, including:

- The maximum recording frame rate in ProRes is 120 frames per second (FPS).
- QuickTime files have the same metadata as the REDCODE RAW files. The metadata is per clip, and not per frame.
- You can select a **Format** from the **Project Settings Menu** and the camera will scale it to the target resolution you select in **ProRes Resolution**.
- Recording 4K ProRes files requires 4K and above formats in 17:9. When in ProRes, formats below 4K will automatically be recorded as 2K or HD.
- For more information about Apple ProRes, including the data rates for each codec, refer to the **Apple ProRes White Paper**.

APPLE PRORES DESCRIPTION

The table below describes each supported Apple ProRes codec.

NAME	CHROMA SAMPLING	DATA RATE
ProRes 4444 XQ	Y' C _b C _r +α 4:4:4:4	1697 Mbps at 4K 17:9 and 24 FPS
ProRes 4444	Y' C _b C _r +α 4:4:4:4	1131 Mbps at 4K 17:9 and 24 FPS
ProRes 422 HQ	Y' C _b C _r 4:2:2	754 Mbps at 4K 17:9 and 24 FPS
ProRes 422	Y' C _b C _r 4:2:2	503 Mbps at 4K 17:9 and 24 FPS
ProRes 422 LT	Y' C _b C _r 4:2:2	350 Mbps at 4K 17:9 and 24 FPS

FILE STRUCTURE OF RECORDED APPLE PRORES FILES

When you record using R3D + ProRes Proxy, this is the file structure of the recorded files on the media:

- .RDM Folder
 - .RDC Folder
 - .mov
 - .R3D
 - .rtn (RED Thumbnail file)

NOTE: The camera creates multiple .mov files, similar to how the camera creates multiple R3D files.

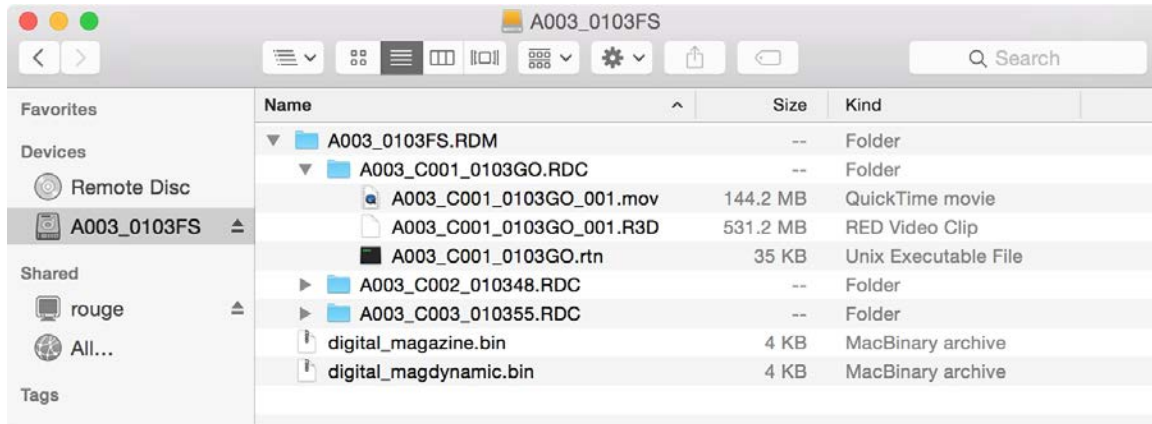

When you record using ProRes format, this is the file structure of the recorded files on the media:

- .RDM Folder
 - .RDC Folder
 - .mov

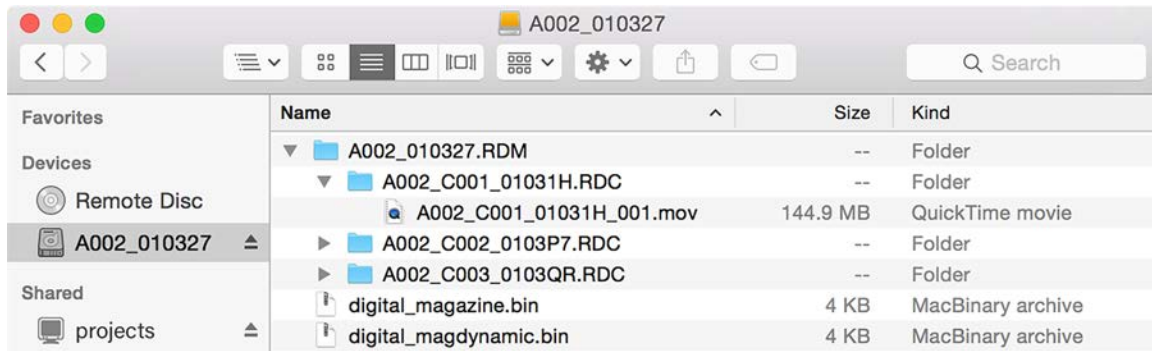

R3D QUALITY

Use R3D Quality to select the R3D data rate the camera uses to record the image files.

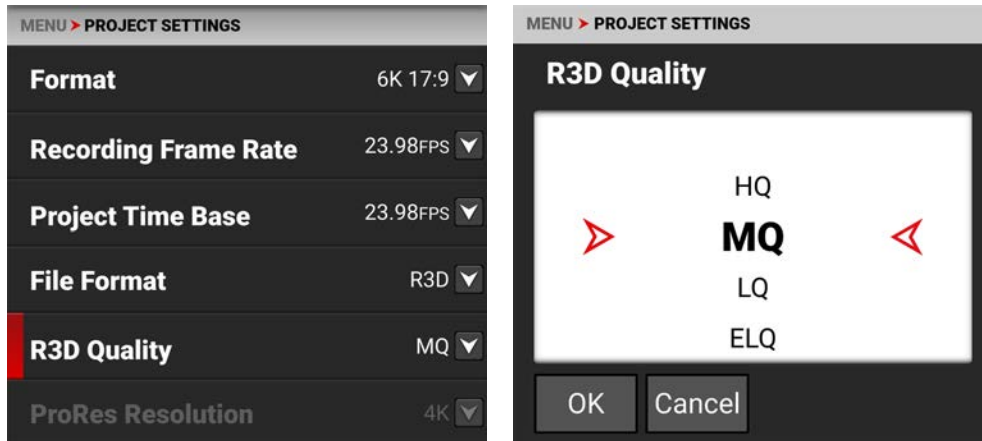

The R3D Quality selections include:

- HQ - High data rate and less recording time
- MQ - Medium data rate (default) and longer recording time
- LQ - Low data rate and long recording time
- ELQ - Lowest data rate and longest recording time

For high complexity scenes, VFX, and stills from motion workflows, RED recommends the HQ setting. For cinema (non-VFX) and high-end TV, RED recommends the MQ setting. For TV, online content, documentary and interviews, RED recommends the LQ setting. ELQ compression mode provides nearly 50% more recording time than LQ, and RED recommends using ELQ for scenes where the complexity is low or the final delivery resolution is lower than the acquisition resolution (downsampling).

R3D QUALITY DATA RATES

FORMAT	24P HQ	24P MQ	24P LQ	24P ELQ
6K 17:9	239 MB/s	168 MB/s	105 MB/s	65 MB/s

PRORES RESOLUTION

When you enable ProRes as the **File Format** you can select the ProRes resolution.

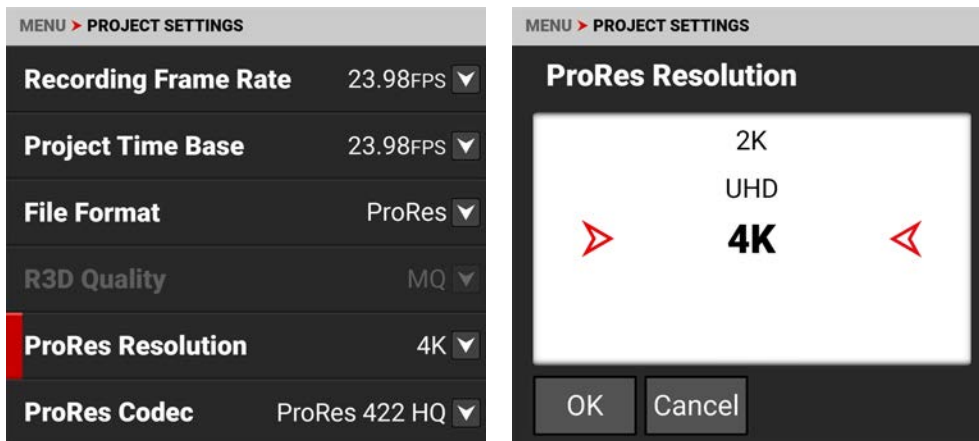

The ProRes Resolution selections include:

- HD (16:9)
- 2K (17:9)
- UHD (16:9)
- 4K (17:9, default).

The camera will downscale to achieve the selected ProRes resolution when the aspect ratios of your format and ProRes resolution do not match. It is recommended to shoot 4K or 2K ProRes when the format is 17:9, and to shoot UHD or HD when the format is 16:9.

PRORES CODEC

When you enable ProRes as the **File Format** you can select the ProRes Codec.

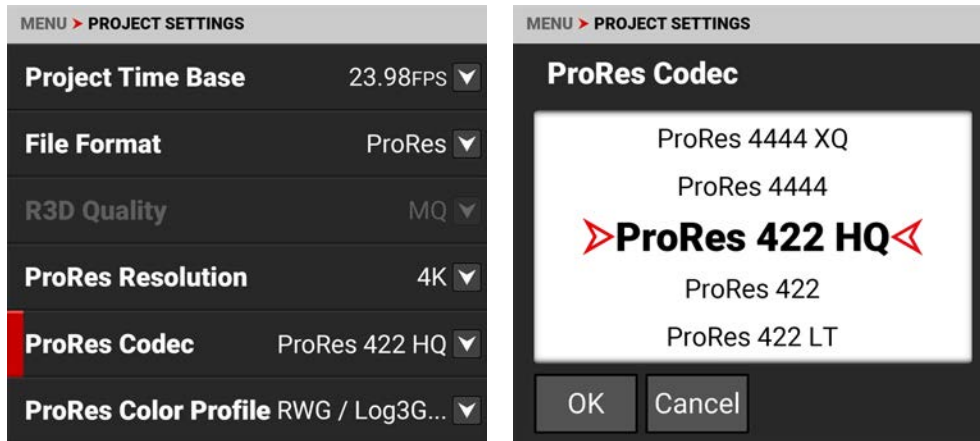

The ProRes Codec selections include:

- ProRes 4444 XQ
- ProRes 4444
- ProRes 422 HQ
- ProRes 422
- ProRes 422 LT

NOTE: Some ProRes codec selections are not available in all frame rates.

PRORES COLOR PROFILE

When you enable ProRes as the **File Format** you can select the color profile.

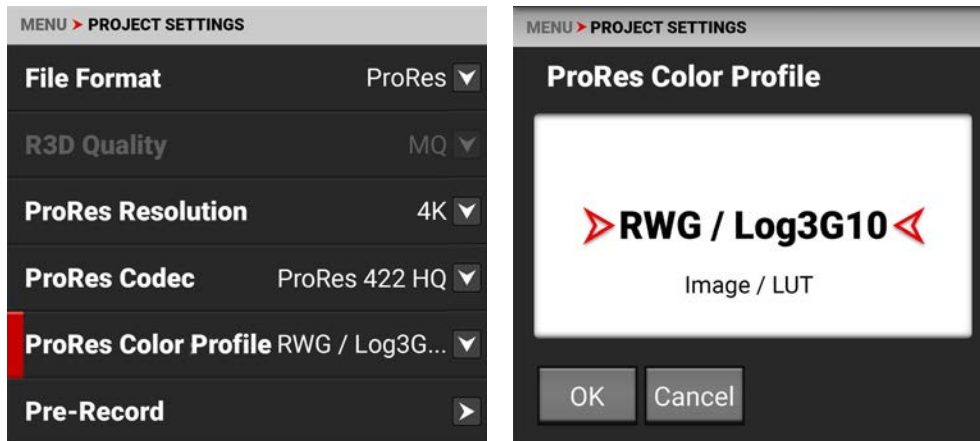

The ProRes Color Profile settings include:

- RWG/Log3G10 - REDWideGamutRGB color space and Log3G10 gamma curve
- Image / LUT - Applies all Image / LUT settings for **Output Color Space**, **Display Preset**, **3D LUT**, and **CDL**.

NOTE: All ProRes Color Profile settings bake in both the ISO and the White Balance settings.

PRE-RECORD

Use the Pre-Record menu to enable or disable Pre-Record, and to adjust the length of the Pre-Recorded clip.

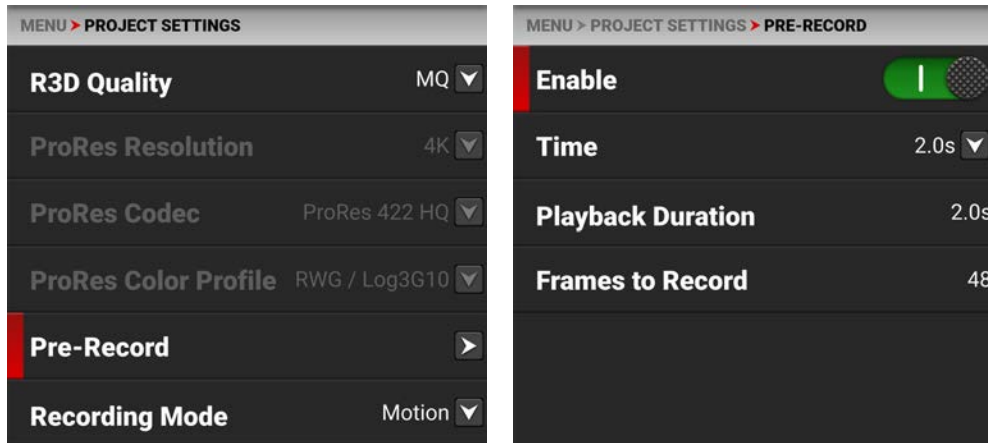

Pre-Record allows you to continually capture images to a small amount of memory while waiting to begin recording. This allows you to capture unexpected events such as, a whale breaching the water, or an athlete scoring a goal. When you finish recording, the pre-recorded clip is added to the beginning of the recording.

You can set the Pre-Record clip to record from half a second up to 30 seconds, depending on the format, file type, resolution, and quality. The default setting is 2 seconds at the default Project Time Base of 23.98 FPS.

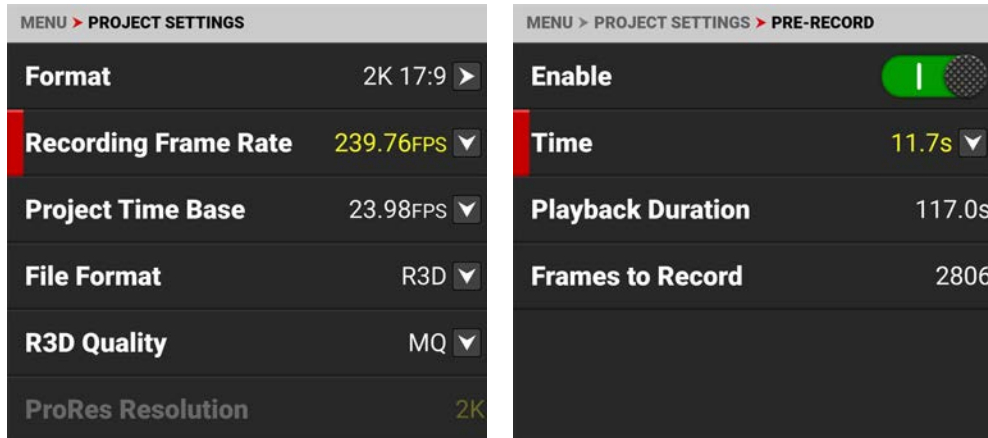

When the selected pre-record time is not possible in the selected format, the closest time available will be shown in **yellow**.

For more information, refer to [Pre-Recording Content](#).

ENABLE

Select Enable to toggle Pre-Record on and off.



TIME

Select Time to choose or enter the number of seconds to pre-record.

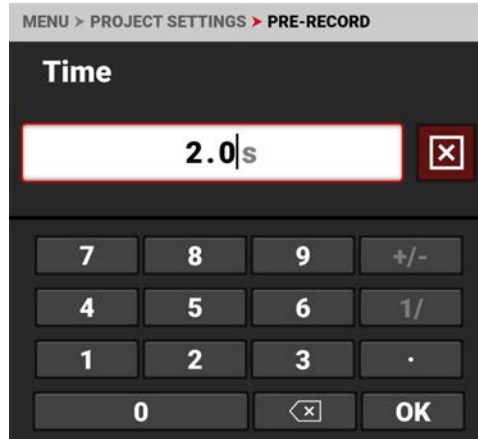
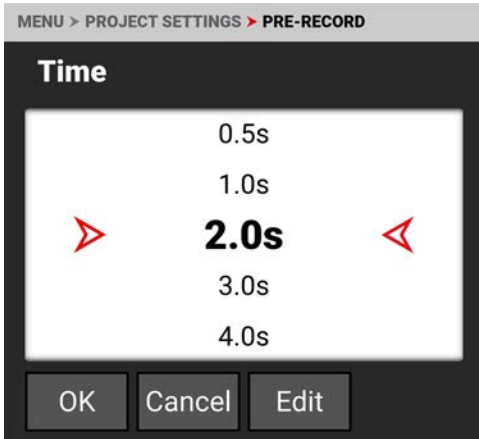

When you select a Time value larger than the current settings allow, the camera changes the Time value to the maximum value it can support and highlights the value in yellow.

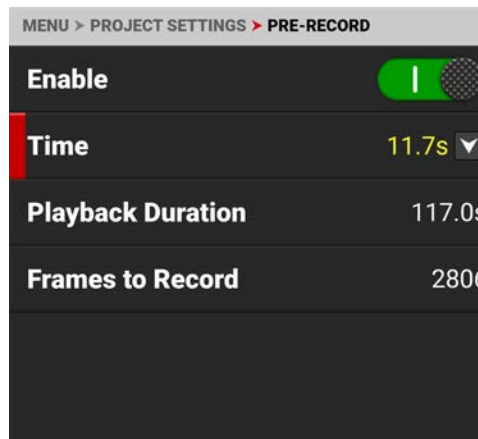
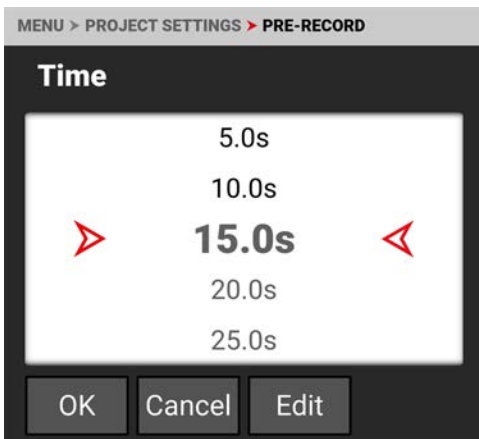

PLAYBACK DURATION

Playback Duration displays the duration in seconds that the pre-record clip will last in playback.

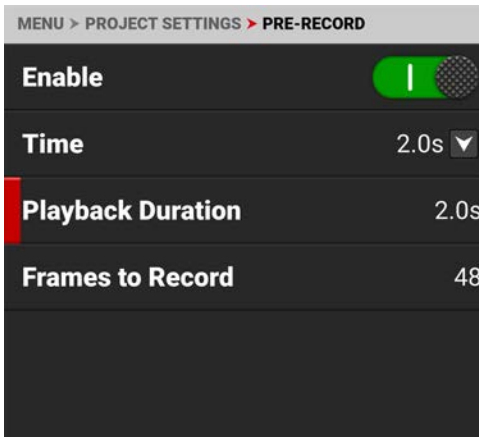

FRAMES TO RECORD

Frames to Record displays the number of frames the pre-recorded clip will contain at the current settings.

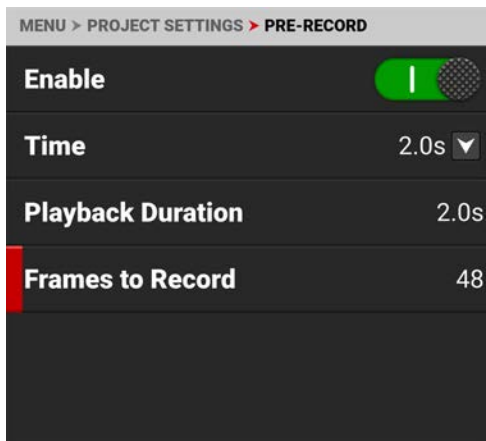

RECORDING MODE

Use Recording Mode to select between normal motion recording or timelapse recording.

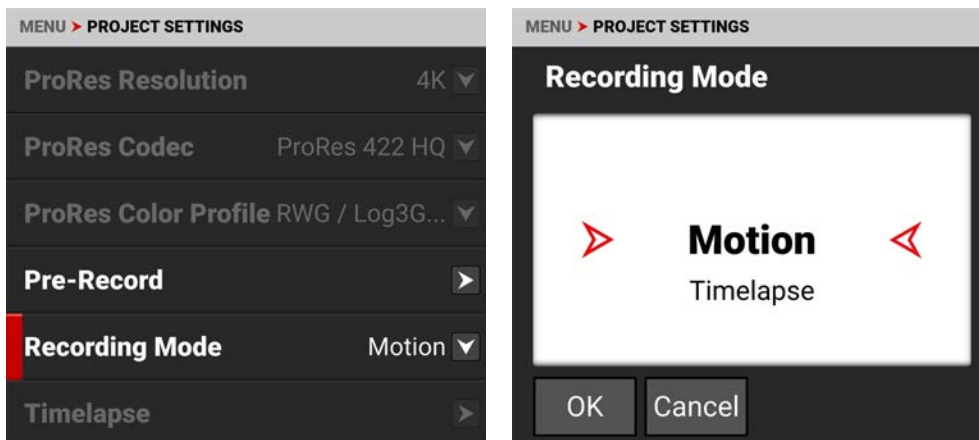

When you select Timelapse, the Timelapse option is enabled on the menu.

TIMELAPSE

Use Timelapse to select the timelapse settings.

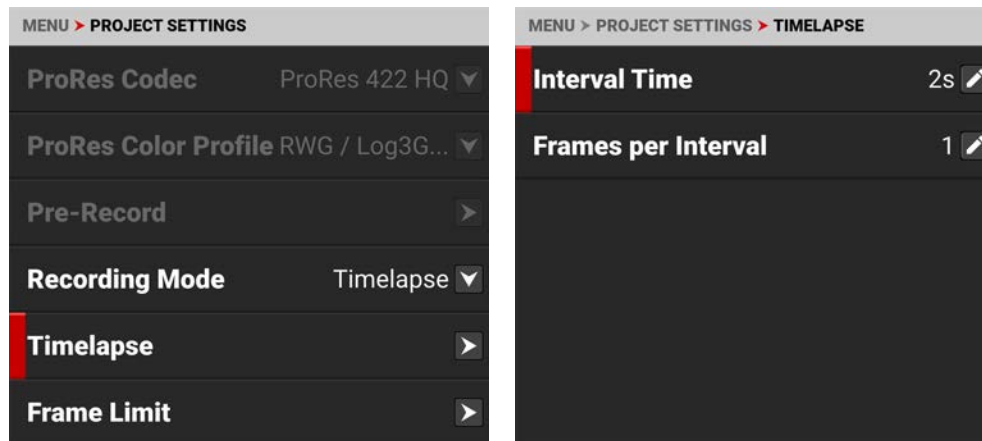

From Timelapse you can select the interval time between the group of frames per interval, and you can select the number of frames captured per interval.

INTERVAL TIME

Select Interval Time to enter the elapsed time between the group of frames per interval.

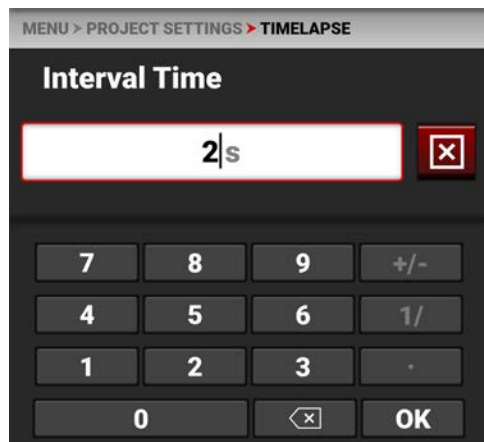

For example:

60s = 1 minute

3600s = 1 hour

86400s = 1 day

FRAMES PER INTERVAL

Select Frames Per Interval to enter the number of frames to record per interval.

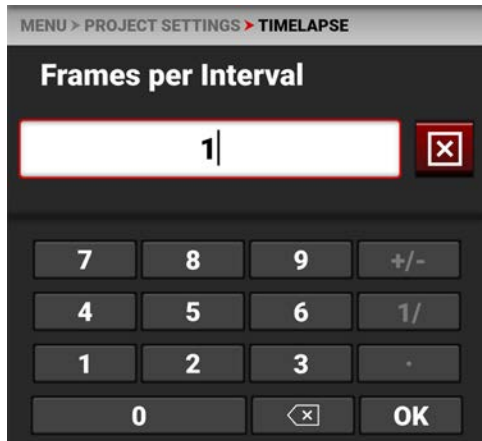

Adding more frames per interval allows you to have more flexibility in post (for example: image stacking).

FRAME LIMIT

Use Frame Limit to limit the total number of frames recorded per clip. Frame limit applies to both Motion and Timelapse recording modes.

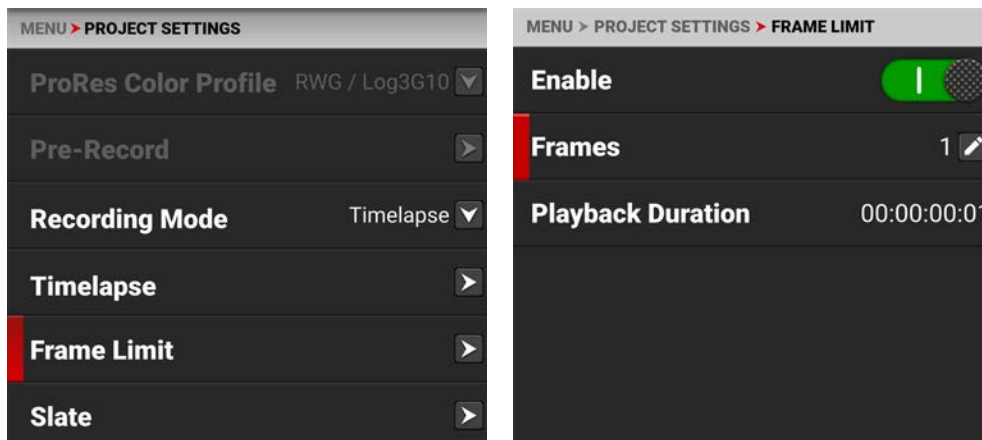

The Frame Limit selections include Enable, Frames, and Playback Duration.

ENABLE

Select Enable to toggle the activation of the Frame Limit feature.



FRAMES

Use frames to enter the maximum number of frames the clip can record.

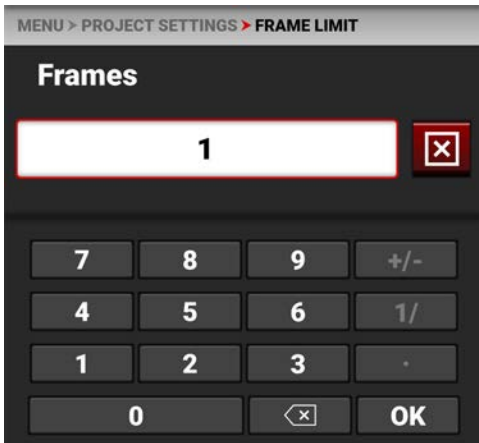

PLAYBACK DURATION

Playback Duration displays the calculated playback duration of the clip with the selected Frame Limit and FPS. For example, using 1440 Frames as a Frame Limit at 24 FPS results in one minute of playback duration.

SLATE

Use the Slate menu to assign a camera ID and camera position to the clip.

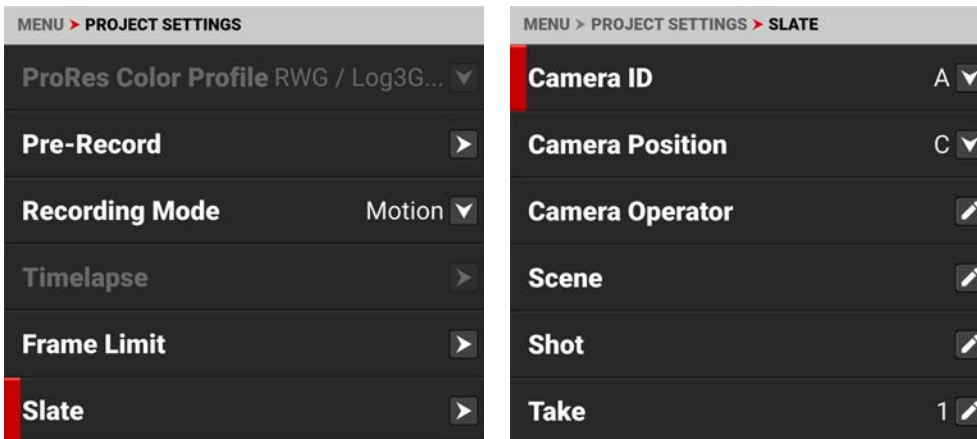

The information you can add to a clip includes:

- Camera ID
- Camera Position
- Camera Operator
- Scene
- Shot
- Take
- Production
- Director
- DoP
- Unit

NOTE: When you set the Camera ID and Camera Position, they are also set in the Media>Secure Format menu items.

CAMERA ID

Use Camera ID to assign a camera ID when the camera records clips.

NOTE: You can also change the Camera ID by using Secure Format (refer to [Secure Format](#)).

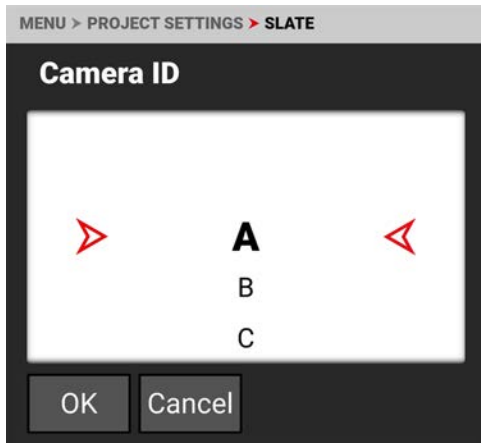

The camera IDs you can assign when recording a clip include the letters A-Z.

CAMERA POSITION

Use Camera Position to assign a camera position letter when the camera records clips.

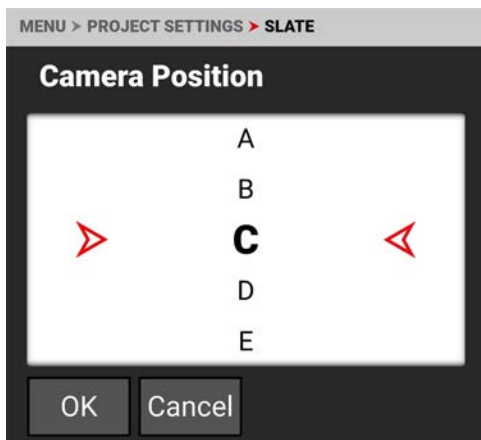

The camera positions you can assign when recording a clip include the letters A-Z.

CAMERA OPERATOR

Use Camera Operator to enter the name of the camera operator.

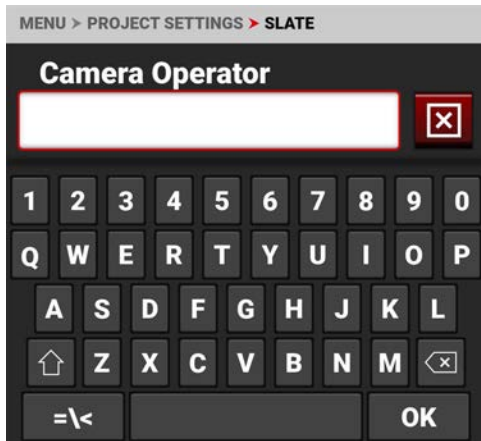

SCENE

Use Scene to enter the scene name.

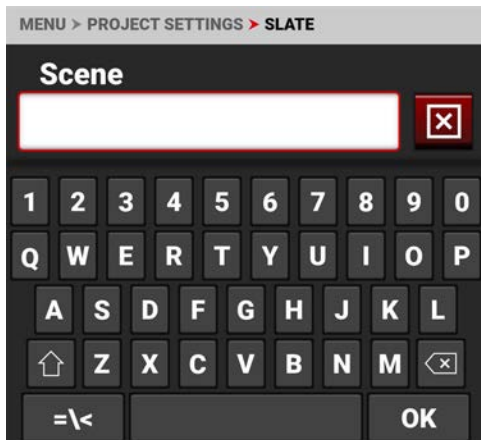

SHOT

Use Shot to enter the number of the shot.

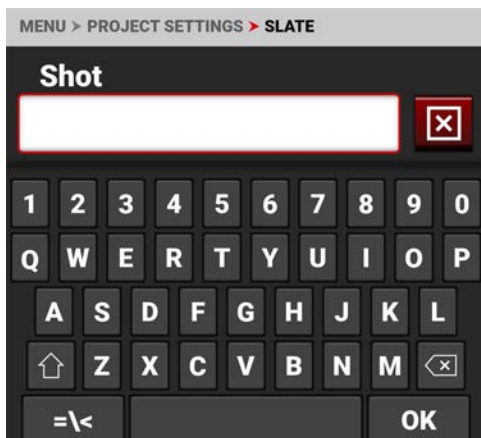

TAKE

Use Take to enter the number of the take.

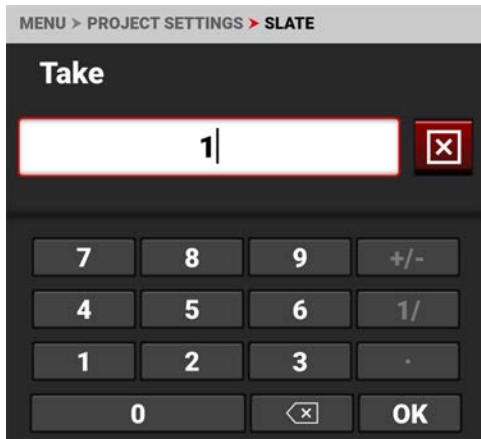

PRODUCTION

Use Production to enter the name of the production.

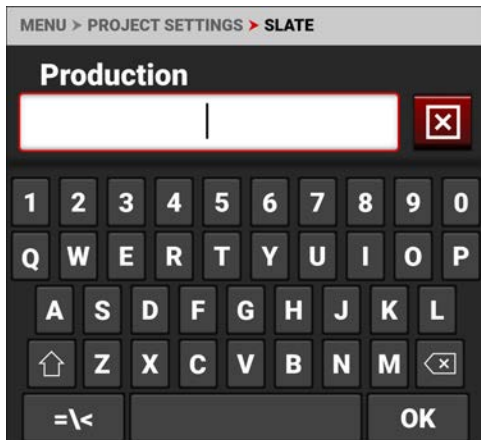

DIRECTOR

Use Director to enter the name of the director.

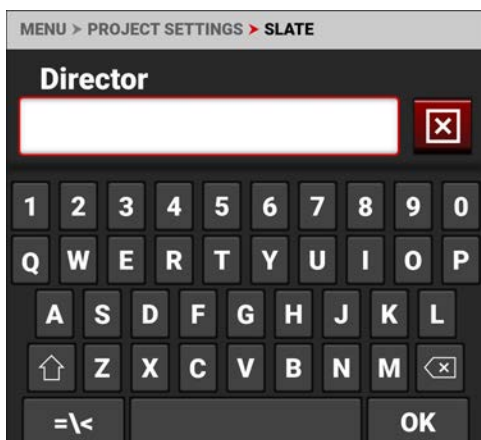

DOP

Use DoP to enter the name of the director of photography.

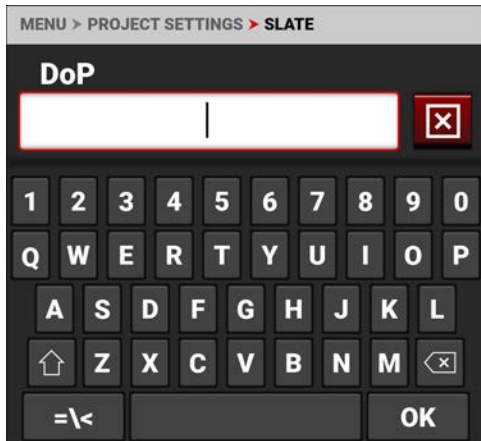

UNIT

Use Unit to enter the name of the production unit.

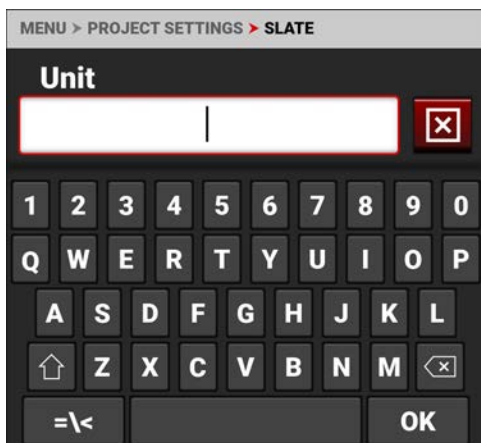

AUDIO / TC MENU

The Audio / TC menu contains the settings you use to configure your camera audio and Timecode.

From the Onboard LCD touchscreen menu, select Audio / TC:

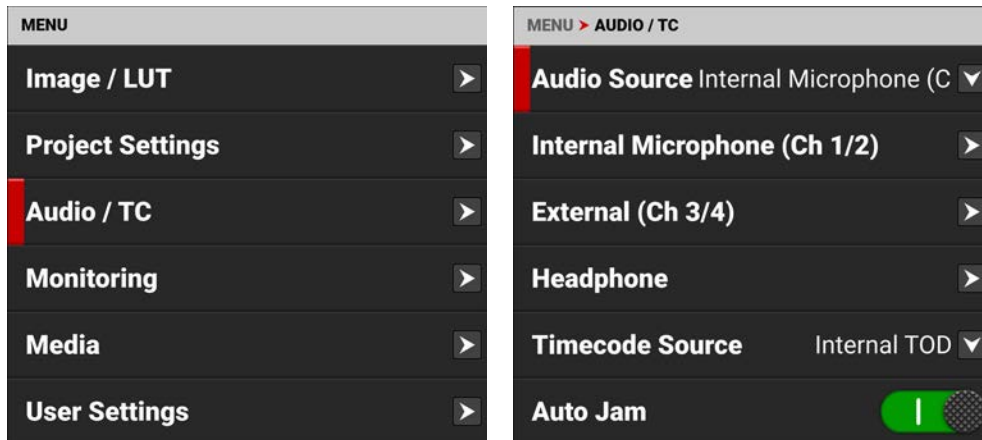

Use the Audio / TC menu to configure the audio and Timecode settings for the camera:

ITEM	DETAILS
Audio Source	Audio input source
Internal Microphone	Left and right internal microphone levels
External (Ch 3/4)	Left and right external audio levels
Headphone	Headphone volume level
Timecode Source	Timecode source
Auto Jam	Button to enable auto-jamming Timecode to time-of-day (TOD) Timecode
Jam Timecode to TOD	Button to jam Timecode to time-of-day (TOD)
Manual Timecode	Button to jam to the camera's internal Timecode generator and edit the Timecode starting number
Timecode Display Mode	Timecode type to display

AUDIO DETAILS

The camera is equipped with two integrated microphones suitable for scratch-track audio (Ch 1 and 2), and it is equipped with a 5-Pin ODU audio connector that accepts 2-channel audio, which is configurable for Line or Mic level inputs, and can provide +48V Phantom power (Ch 3 and 4).

You can link the gain for the two internal channels together and you can link the two external channels together. This allows you to adjust the two internal (or external) channels together as one.

You can record audio from the internal microphones, from the external audio connector (2-channel recording), or from internal and external sources combined as four 24-bit 48 kHz uncompressed audio tracks.

You can adjust the external audio by using the appropriate camera gain-settings. The default camera gain setting is 1 dB.

The camera's audio data is synchronized with video and timecode, and it is embedded in the R3D file. You can export the audio data as separate audio files by using REDCINE-X PRO, if needed. The camera also embeds the audio in the SDI output.

You can monitor the audio during recording and playback by using the equipped 3.5 mm stereo headphone port.

SDI AUDIO

When you select Internal Microphone (Ch 1/2) as the audio source, the camera routes the Internal Microphone signals to SDI channels 1 and 2. When you select External (Ch 3/4), the camera routes the External audio signal to SDI channels 1 and 2. When you select Internal + External, the camera routes the Internal Microphone signal to SDI channels 1 and 2, and the External Audio signal to SDI channels 3 and 4.

VARISPEED AUDIO

This camera has the ability to record audio when the camera's Recording Frame Rate is set to a higher speed than the Project Time Base setting (Varispeed mode).

NOTE: The camera records the audio as a separate WAV file and stores it in the clip's RDC folder on the media drive.

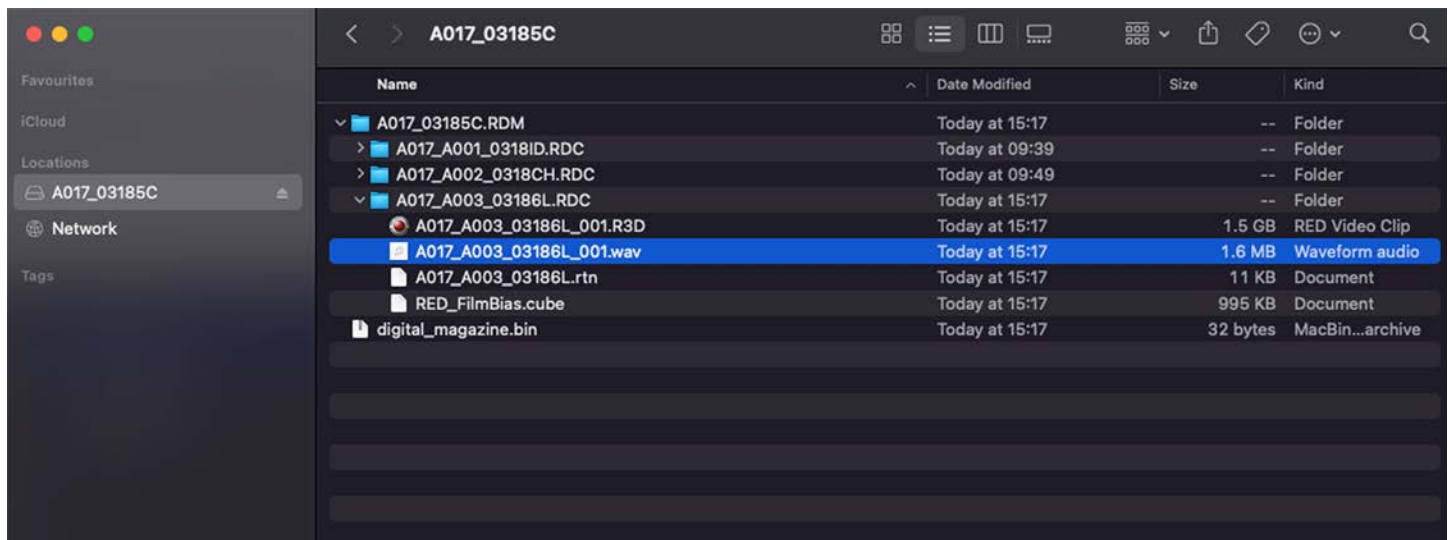

TIMECODE DETAILS

Timecode provides a mechanism to reference frames from the camera's recorded clips to external devices, such as other cameras or audio recorders. Some devices can also gather additional data such as lens metadata, or camera orientation, which Timecode can later use for merging the data back together in post-processing.

The camera provides two separate Timecode formats:

- **Time Of Day (TOD)** - The camera records the time of day as the Timecode for each clip
- **Edgecode** - The camera records elapsed time as the Timecode for each clip. The time is reset to 01:00:00 when a new media card is inserted in the camera. All of the clips on the media will have a continuous Timecode track. However, each new media card will default to a Timecode track starting at 01:00:00. Edgecode is equivalent to RUN RECORD as used on broadcast cameras. You can change the Edgecode to begin at any desired time by using the Media Format menu (refer to [Edgecode](#)).

The camera synchronizes (jams) the TOD Timecode to an external Timecode generator (when one is connected to the camera) or it jams the Timecode to its internal real-time clock.

When using Internal TOD, a jam between the running timecode and a real time clock is required. The time at which this jam occurs will have an effect on the overall timecode drift over a 24-hour period due to the nature of non-drop-frame (NDF) timecode. By enabling Auto-Jam, the camera automatically jams its timecode, ensuring repeatable drift across multiple cameras and days.

When Auto Jam is disabled, you can manually pick the instant in which you want to jam timecode to the real time clock.

The camera stores TOD and Edgecode in the R3D file. You can select which one you want to display on the side [Onboard LCD Touchscreen](#) (refer to [Timecode Display Mode](#)).

AUDIO SOURCE

Use the Audio Source settings to select the audio input source.

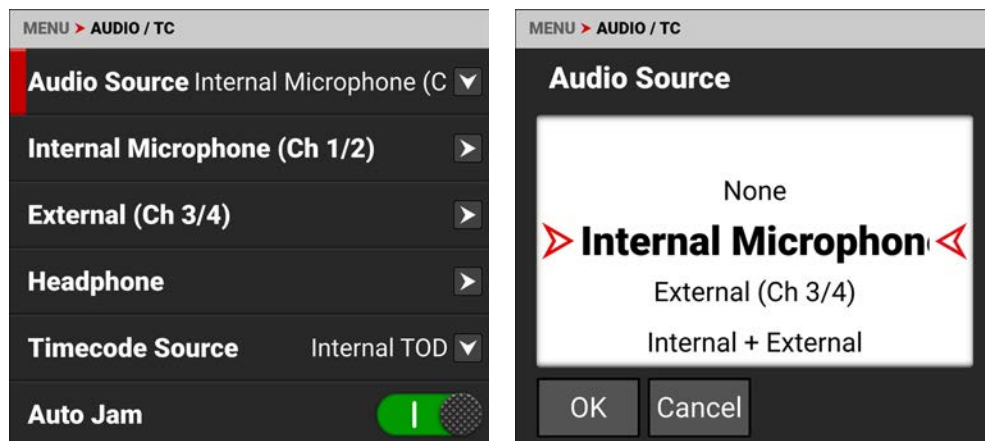

The audio input sources include:

- None
 - Internal Microphone - enables the **Internal Microphone** channels 1 and 2 (default)
 - External - enables the 5-pin 00B Audio Input port for **External Audio** channels 3 and 4
 - Internal and External - enables the Internal Microphone and the 5-pin 00B **Audio Port** for all channels 1 through 4.
- NOTE:** The headphones can only monitor two channels. You can either monitor channels 1 and 2 (internal microphone) or you can monitor channels 3 and 4 (external port). Refer to **Audio Tools** for more information.

INTERNAL MICROPHONE

Use the Internal Microphone settings to set the left and right internal microphone levels. This menu is only enabled when the **Audio Source** is set to Internal Microphone or Internal and External.

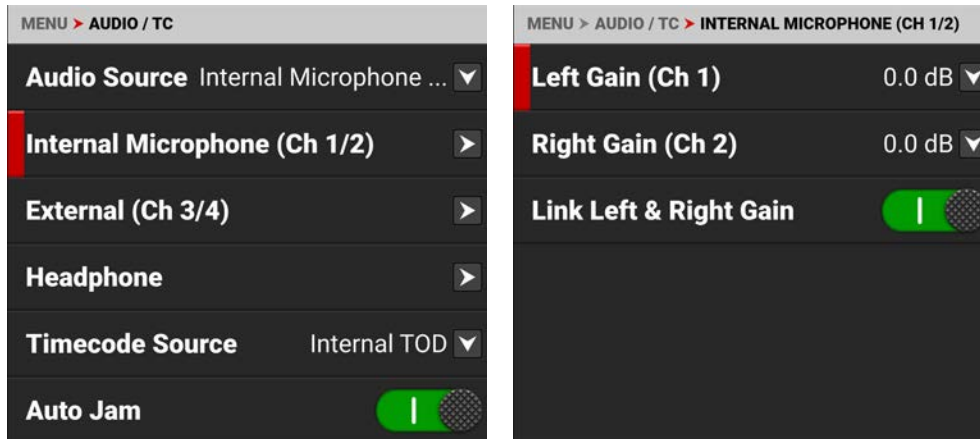

The Internal Microphone is represented as Channels 1 and 2 on the UI VU Meters (refer to **Playback** for more information). The left channel is channel 1 (Ch 1) and the right channel is channel 2 (Ch 2).

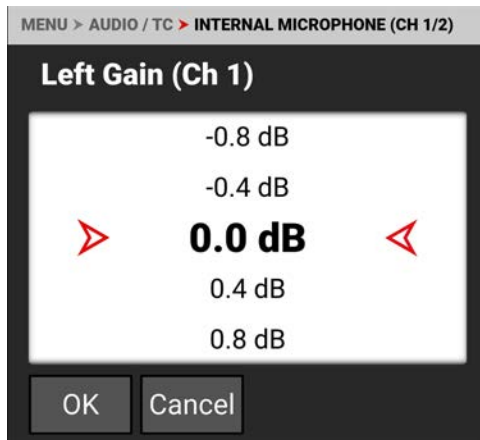

You can adjust the internal audio levels for left and right from -52.5 dB to 36.0 dB.

The default setting is 0 dB.

When you enable Link Left & Right Gain, the adjustments you make to either channel of gain will adjust both channels to the same setting.

EXTERNAL AUDIO

Use the External Audio settings to set the left and right external audio levels. This menu is only enabled when the **Audio Source** is set to External or set to Internal and External.

NOTE: When the Recording Frame Rate is set to a higher speed than the Project Time Base setting, audio is recorded as varisped audio.

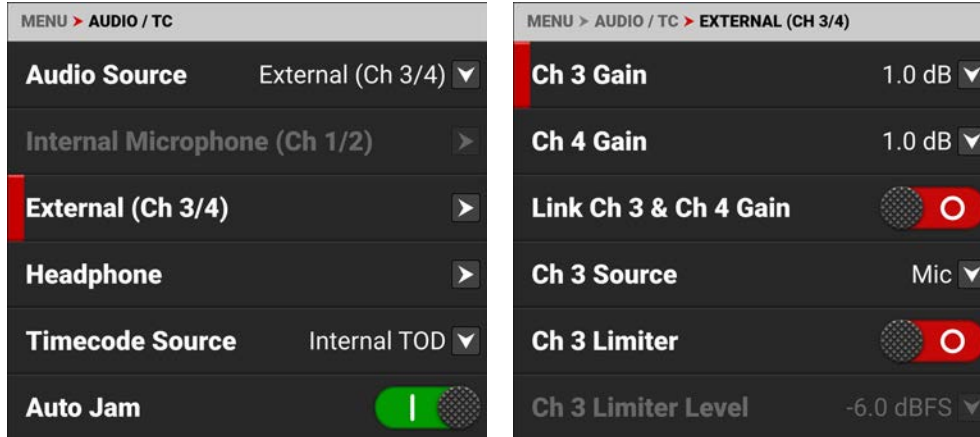

The External Microphone is represented as Channels 3 and 4 on the UI VU Meters (refer to **Playback** for more information).

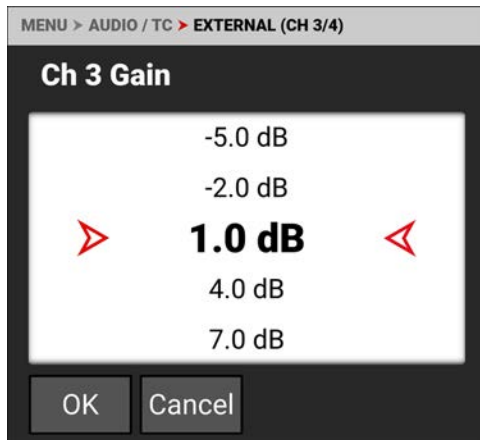

You can adjust the external audio levels for Ch 3 and Ch 4 from -8.0 dB to 34.0 dB.

The default setting is 1.0 dB.

When you enable Link Ch 3 & Ch 4 Gain, the adjustments you make to either channel of gain will adjust both channels to the same setting.

SOURCE

Use Source to select the type of input connected to external audio channel 3 and 4 ports.

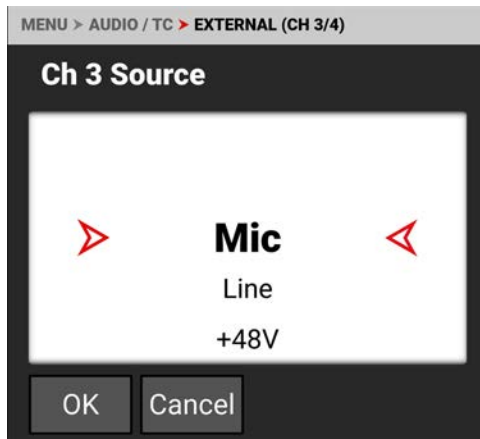

You can select microphone, line, or +48V phantom power.

The default setting is microphone (Mic).

LIMITER

When enabled, use the limiter to place a limit past which the audio level for channels 3 and 4 cannot exceed.

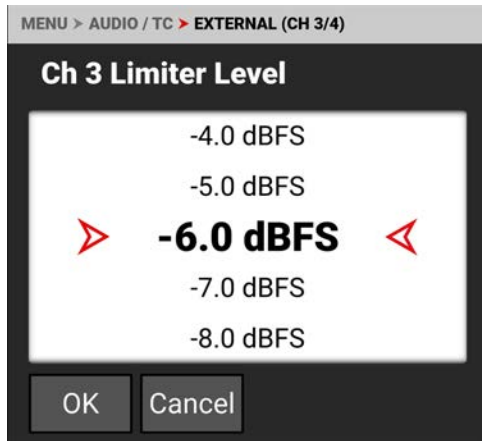

You can select from -2.0 to -12.0 Decibel Full Scale (dBFS) as the limit. The default limit is -6.0 dBFS.

HEADPHONE

Use the Headphone settings to enable the headphone jack and to adjust the headphone volume.

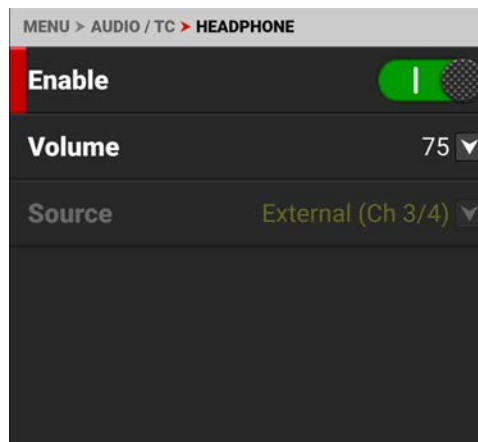
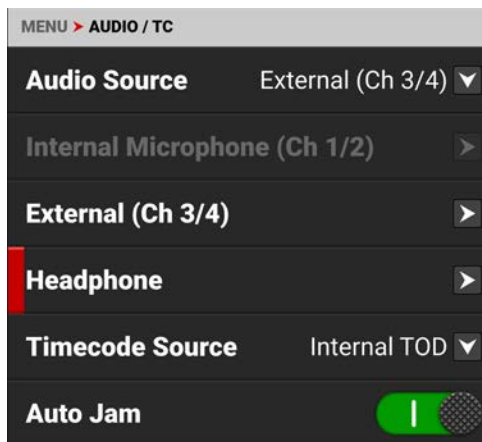

You can enable and disable the headphone audio jack by tapping the Enable toggle to the right (green) and to the left (red).



You can adjust the headphone volume from 0 to 100. The default is 75.

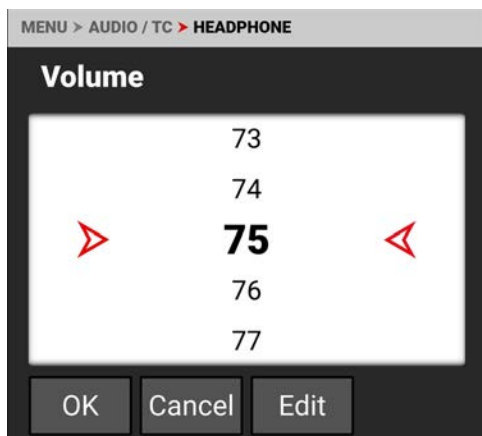

TIMECODE SOURCE

Use Timecode source to configure the Timecode source the camera applies to the recordings.

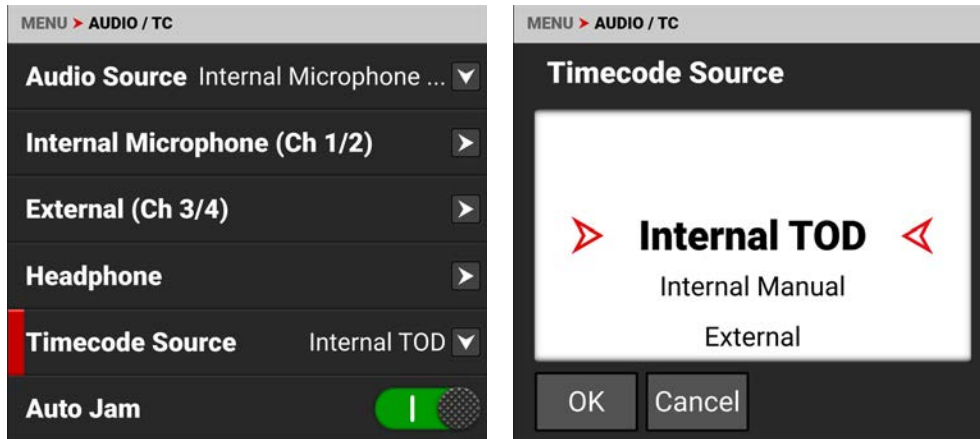

You can select the following Timecode sources:

- Internal Time of Day (TOD)
- Internal Manual
- External
- Precision Time Protocol (PTP)

INTERNAL TOD

Use Internal Time of Day (TOD) to JAM to the camera's internal Timecode generator. When using Internal TOD, a jam between the running timecode and a real time clock is required. The time at which this jam occurs will have an effect on the overall timecode drift over a 24-hour period due to the nature of non-drop-frame (NDF) timecode.

By enabling Auto-Jam, the camera automatically jams its timecode, ensuring repeatable drift across multiple cameras and days. When Auto Jam is disabled, you can manually pick the instant in which you want to jam timecode to the real time clock.

INTERNAL MANUAL

Use Internal Manual to JAM to the camera's internal Timecode generator and edit the Timecode starting number.

Select Manual Timecode OK to open the JAM and editing options:

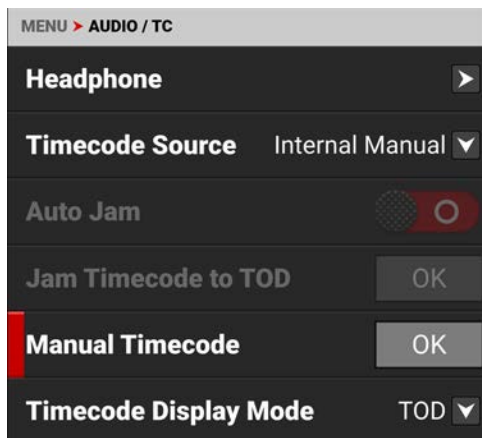

Select JAM to jam to the internal Timecode or select Manual Timecode to open the editing screen:

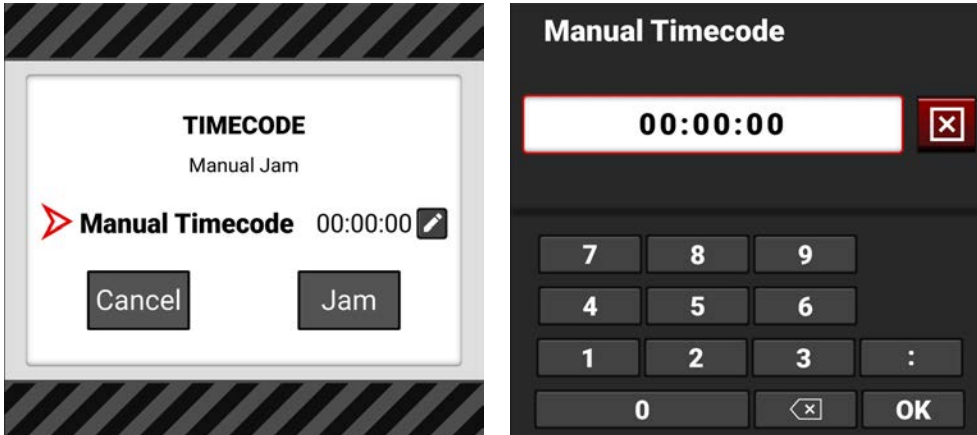

Enter the desired Timecode number and select OK. Select JAM to jam to the edited Timecode number.

EXTERNAL

Use External to connect an external Timecode generator to the 9-contact 0B Extension port (refer to [Camera Body](#) and [Extension Port](#) for more information).

PRECISION TIME PROTOCOL (PTP)

Precision Time Protocol (SMPTE 2059-1) is a network-based synchronization method which when configured using a USB-C to Ethernet adapter offers a level of precision that supports frame-accurate camera synchronization over IP. PTP in the KOMODO-X camera body only offers frame-level precision and therefore cannot be used for sensor scan synchronization. PTP Timecode can be sent over USB-C through an Ethernet adapter.

TIMECODE DISPLAY MODE

Use Timecode Display Mode to configure the Timecode display type that the camera applies to the recordings.

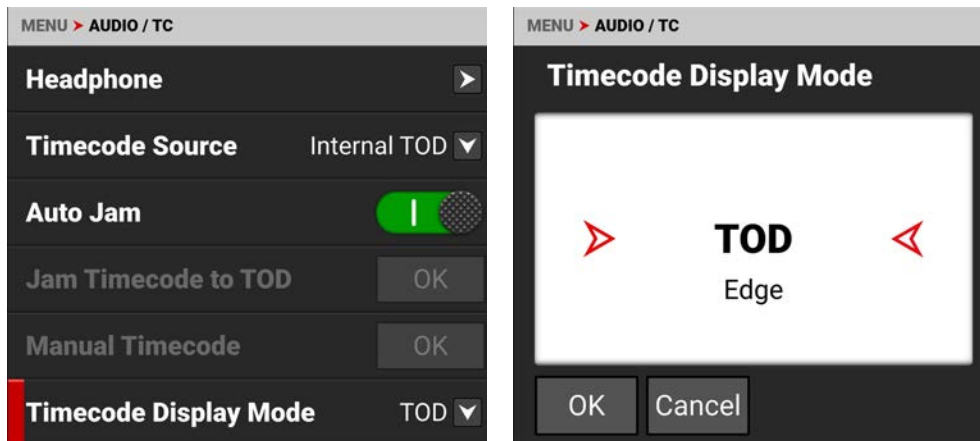

You can set the Timecode Display Mode as Time of Day (TOD) or Edgecode (Edge).

TOD DISPLAY MODE

Time of Day (TOD) display mode displays the Timecode as the time of day that the frame was recorded.

EDGE DISPLAY MODE

Edgecode (Edge) display mode displays the Timecode as the sequential recording time that has elapsed starting with the first frame. In the Media > Secure Format > Edgecode menu, you can enter a unique edgecode number as the starting number on the media.

Edgecode is a SMPTE Timecode track, which by default starts at 01:00:00 on the first frame of each media card. It is a sequential code that is continuous from frame to frame and also between clips. Edgecode is equivalent to RUN RECORD as used on broadcast cameras.

MONITORING MENU

The Monitoring menu contains the settings you use to configure your camera monitoring options.

From the **Onboard LCD Touchscreen** menu, select Monitoring:

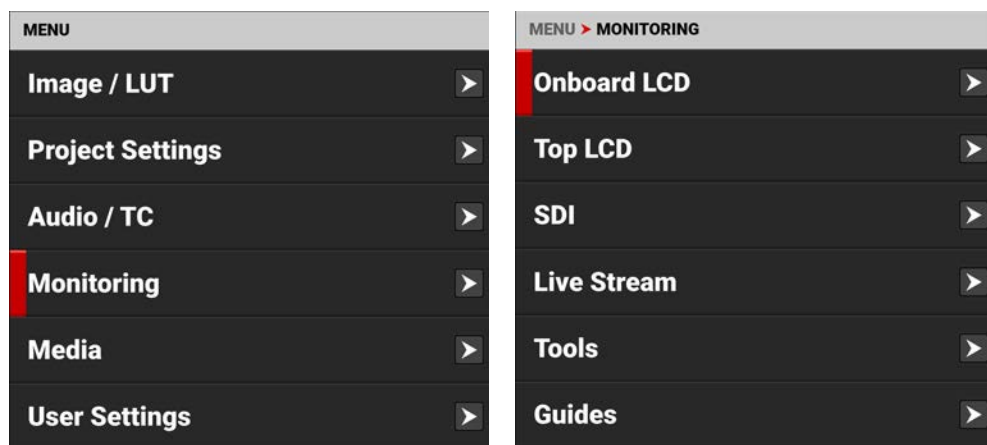

Use the Monitoring menu to configure the monitoring settings:

ITEMS	DETAILS
Onboard LCD	Onboard LCD Touchscreen settings
Top LCD	DSMC3™ RED® Touch 7.0" LCD settings
SDI	SDI port resolution, frequency, look, guides, tools, overlay, and overlay mode
Live Stream	Enable or disable Wi-Fi live streaming
Tools	Various monitoring tools including False Color , Peaking , and Zebra Modes
Guides	Frame guides and a center guide

ONBOARD LCD

Use Onboard LCD to configure the **Onboard LCD Touchscreen** settings.

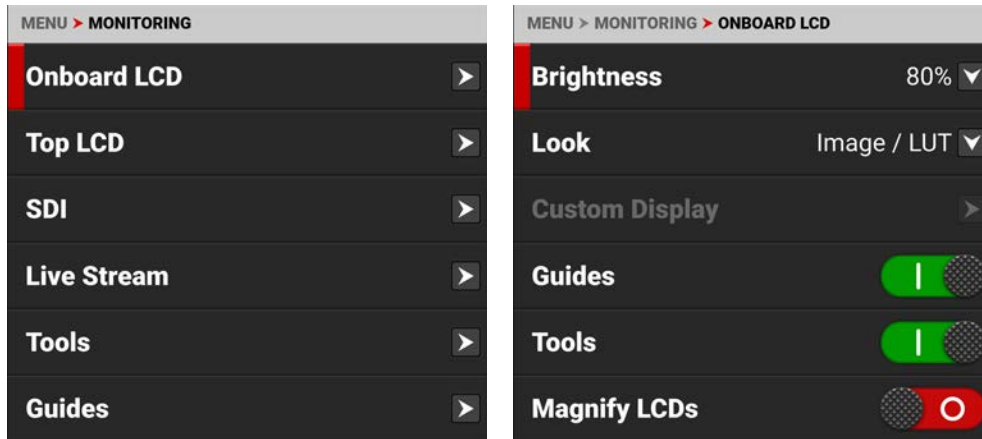

The LCD settings you can configure include:

ITEMS	DETAILS
Brightness	Adjust the Onboard LCD touchscreen brightness
Look	Select the Image / LUT, RWG, Log3G10, or a Custom Display image preview
Custom Display	Configure the Custom Display settings when enabled
Guides	Enable or disable the camera guides
Tools	Enable or disable the camera tools
Magnify LCDs	Enable or disable LCDs magnification
Magnify Position (Global)	Select the magnification area position
Prism Finder Mode	Enable or disable the prism finder mode (horizontally flip the LCD)

BRIGHTNESS

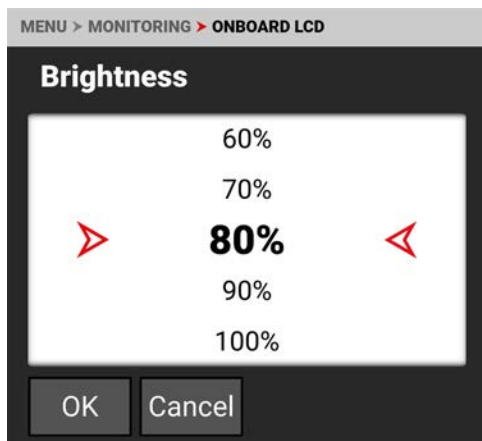

You can adjust the camera's top LCD brightness from 10% to 100%. The default is 80%

LOOK

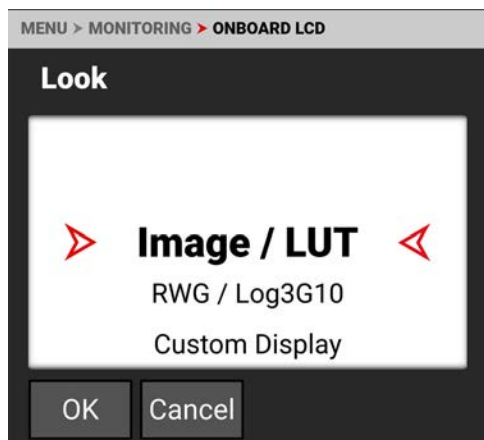

You can select the look of the image preview signal sent to the Top LCD.

The selections include:

- Image / LUT (default)
- REDWideGamutRGB / Log3G10
- Custom Display (enables the Custom Display menu)

CUSTOM DISPLAY

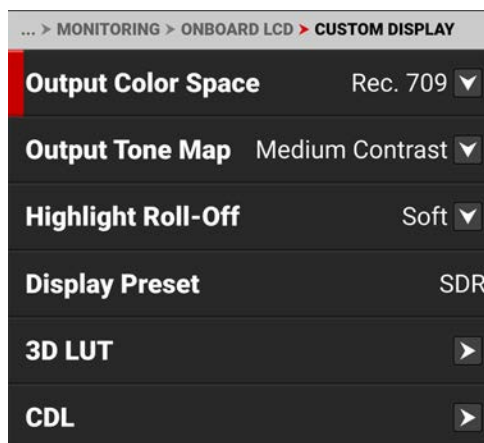

Use Custom Display (enabled from the Look menu) to select the Onboard LCD's Image/LUT settings.

Refer to [Image / LUT Menu](#) for more information about the specific look settings and menus.

GUIDES

Use the toggle to enable (default) or disable the camera guides.



TOOLS

Use the toggle to enable (default) or disable the camera tools.



MAGNIFY LCDS

Use the toggle to enable or disable (default) Onboard LCD and Top LCD magnification.



MAGNIFY POSITION (GLOBAL)

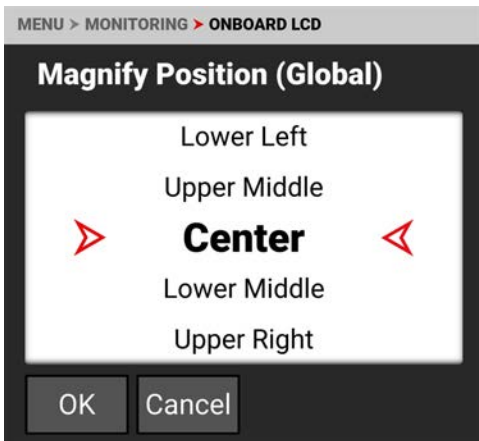

Use Magnify Position (Global) to select the position of the magnified area for all LCD magnification.

PRISM FINDER MODE

Use the toggle to enable or disable (default) the LCD flip view.



TOP LCD

Use Top LCD to configure the **DSMC3™ RED® Touch 7.0" LCD** settings.

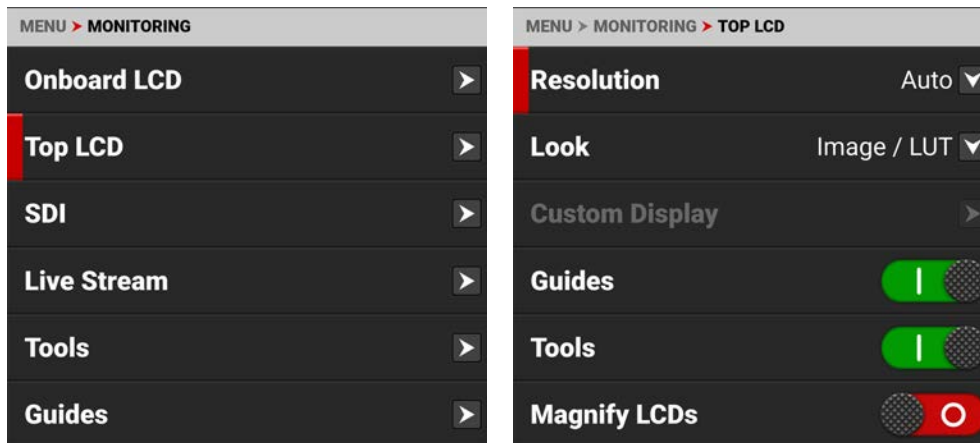

The LCD settings you can configure include:

ITEMS	DETAILS
Resolution	Adjust the RED® Touch 7.0" LCD resolution
Look	Select the Image / LUT, RWG, Log3G10, or a Custom Display image preview
Custom Display	Configure the Custom Display settings when enabled
Guides	Enable or disable the camera guides
Tools	Enable or disable the camera tools
Magnify LCDs	Enable or disable LCD magnification
Magnify Position (Global)	Select the LCD magnification area position
Prism Finder Mode	Enable or disable the prism finder mode (horizontally flip the LCD)

RESOLUTION

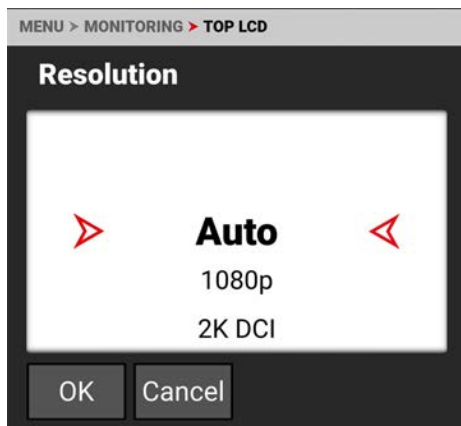

You can select the resolution of the Top LCD.

The selections include:

- Auto (default)
- 1080p
- 2K DCI

LOOK

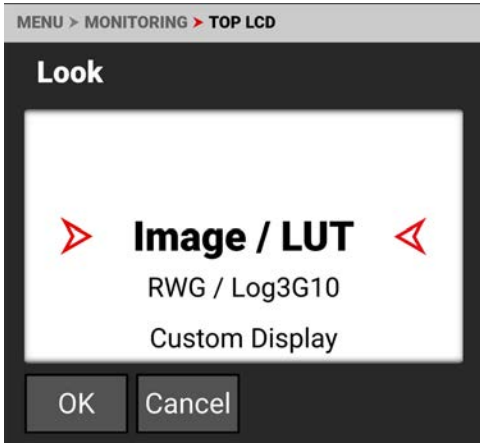

You can select the look of the image preview signal sent to the Top LCD.

The selections include:

- Image / LUT (default)
- REDWideGamutRGB / Log3G10
- Custom Display (enables the Custom Display menu)

CUSTOM DISPLAY

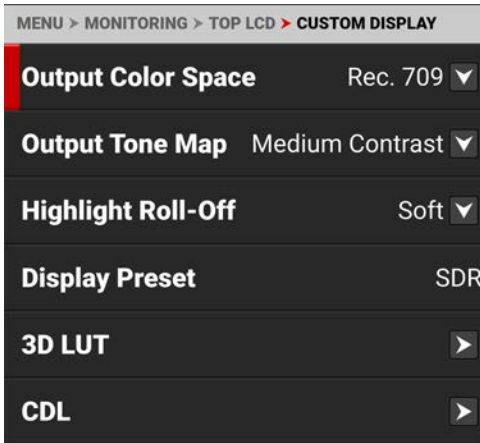

Use Custom Display to configure the Top LCD independently of the camera's Image / LUT settings or other monitor output configurations.

Refer to [Image / LUT Menu](#) for more information about the Image/LUT settings and menus.

GUIDES

Use the toggle to enable (default) or disable the camera guides.



TOOLS

Use the toggle to enable (default) or disable the camera tools.



MAGNIFY LCDS

Use the toggle to enable or disable (default) LCD magnification.



MAGNIFY POSITION (GLOBAL)

Use Magnify Position (Global) to select the position of the magnified area for all LCD magnification.

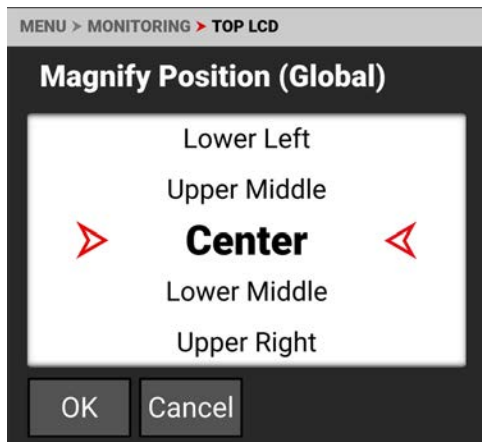

Use Magnify Position to globally select the area of the image you want to magnify.

The selections include:

- Left
- Upper Middle
- Upper Right
- Upper Left
- Center (default)
- Lower Right
- Lower Left
- Lower Middle
- Right

PRISM FINDER MODE

Use the toggle to enable or disable (default) the LCD flip view.



SDI

Use SDI to configure the SDI port settings.

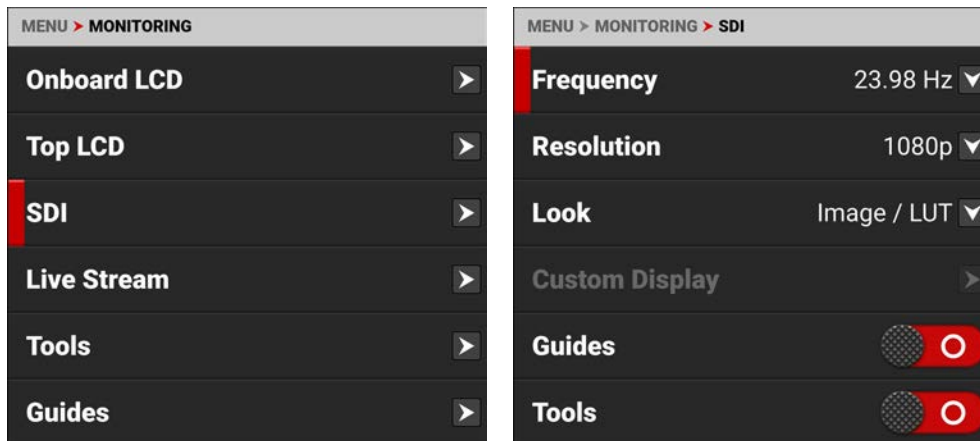

The SDI port settings you can configure include:

ITEMS	DETAILS
Frequency	Select the SDI port frequency
Resolution	Select the SDI port resolution
Look	Select the Image / LUT, RWG, Log3G10, or a Custom Display image preview
Custom Display	Configure the Custom Display settings when enabled
Guides	Enable or disable the monitor guides
Tools	Enable or disable the monitor tools
Magnify	Enable or disable monitor magnification
Magnify Position (Global)	Select the magnification area position
Overlay	Enable or disable the monitor overlay
Overlay Mode	Select the overlay type
Overlay Opacity	Select the opacity of the overlay
Flip / Mirror	Flip and mirror the image output to the monitor

WARNING: Under certain circumstances, it is possible for an SDI connector to incur damage when connected to an accessory and powered without using shielded cables. RED recommends only using high quality, shielded BNC cables that are rated for 12G-SDI signals and only using shielded power cables for powering SDI accessories.

Make sure power is connected to the SDI accessory at all times before you connect the BNC to the camera. Ungrounded power from SDI accessories can damage the camera's SDI port. To avoid this possible damage, attach the power source to the accessory before attaching it to the BNC cable. When using RED Approved Third Party battery plates, unplug the BNC cable prior to hot swapping.

When possible, avoid using P-Tap (also known as D-Tap) cables to power accessories. To avoid damage when using P-Tap/D-Tap, it's imperative that the connect/disconnect sequence (below) is followed precisely.

BNC ATTACHMENT INSTRUCTIONS

When attaching SDI accessories:

1. Connect a power source to the SDI accessory; power on the SDI accessory.
2. Ensure a power source is connected to the camera. This ensures both are grounded prior to connecting the BNC. The camera's power state does not have an impact on SDI attachment sequence.
3. Connect the BNC cable to the accessory, then to the camera.

When detaching an accessory mounted to an SDI output, ensure that you remove the BNC connection to the camera before removing power to the SDI device:

1. Shutdown the SDI accessory.
2. Disconnect the BNC cable from the camera.
3. Disconnect the power source from the SDI accessory.

When you need to swap out a battery on an accessory mounted to the camera's SDI port, you must:

1. Shutdown the SDI accessory.
2. Disconnect the BNC cable from the camera.
3. Replace the battery on the SDI accessory.
4. Connect the BNC cable to the camera.
5. Power on the SDI accessory.

For more information, refer to [Preventing Damage to SDI Outputs](#).

FREQUENCY

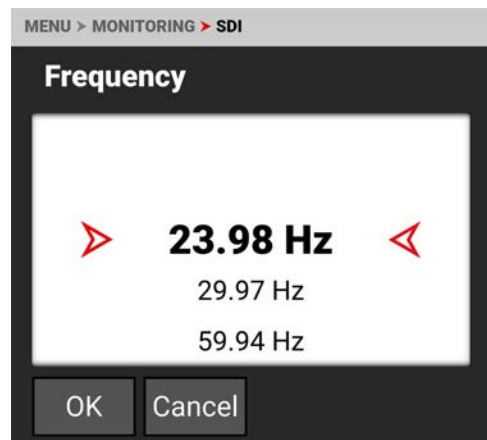

Use Frequency to select one of the following SDI port frequency settings:

- 23.98 Hz (default)
- 29.97 Hz
- 59.94 Hz

RESOLUTION



Use resolution to select one of the following SDI port resolution settings:

- 1080p (default)
- 2K DCI
- 4K UHD
- 4K DCI

The resolution selected here controls the SDI output resolution of the preview page.

SCALING PREVIEW

When monitoring in 1080p or 4K UHD while capturing in a 17:9 format, the entire 17:9 image will be down-scaled to the 16:9 aspect ratio of 1080p or 4K UHD. Small black bars will only appear on the top and bottom of the frame in the monitor path and not on the recorded image.

LOOK

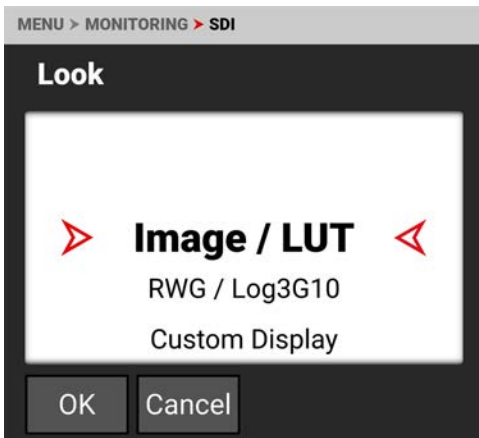

You can select the look of the image preview signal sent to the SDI port.

The selections include:

- Image / LUT (default)
- REDWideGamutRGB / Log3G10
- Custom Display (enables the Custom Display menu)

CUSTOM DISPLAY

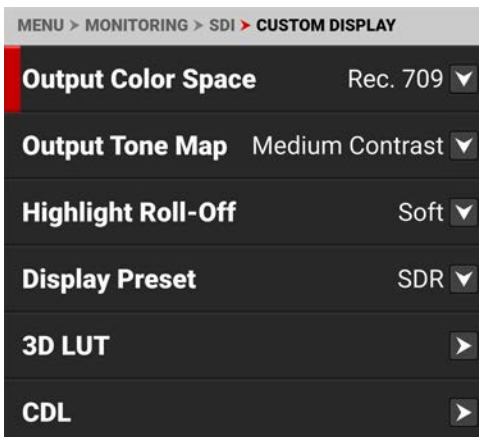

Use Custom Display (enabled from the Look menu) to select the SDI's isolated look settings.

Refer to [Image / LUT Menu](#) for more information about the specific look settings and menus.

GUIDES

Use Guides to enable or disable (default) the viewing of guides. Tap the switch to toggle between enabled and disabled.



TOOLS

Use Tools to enable or disable (default) the viewing of tools. Tap the switch to toggle between enabled and disabled.



MAGNIFY

Use Magnify to enable or disable (default) monitor magnification. Tap the switch to toggle between enabled and disabled.



MAGNIFY POSITION (GLOBAL)

Use Magnify Position (Global) to select the position of the magnified area for all magnification.

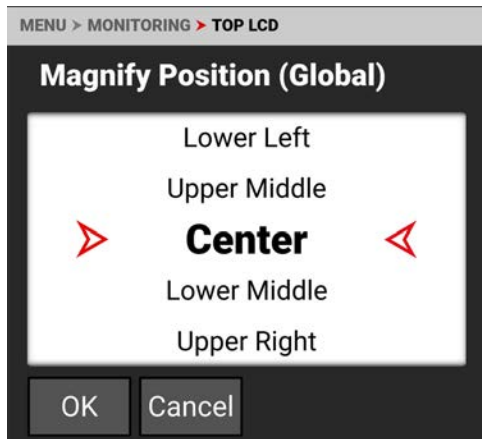

Use Magnify Position to globally select the area of the image you want to magnify.

The selections include:

- Left
- Upper Middle
- Upper Right
- Upper Left
- Center (default)
- Lower Right
- Lower Left
- Lower Middle
- Right

OVERLAY

Use Overlay to enable (default) or disable the viewing of the overlay. Tap the switch to toggle between enabled and disabled.



OVERLAY MODE

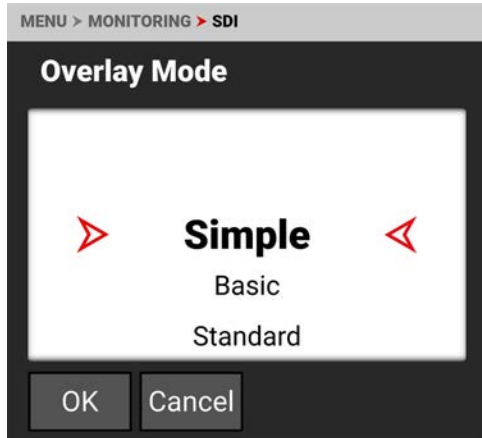

Use Overlay Mode to select one of the following SDI port overlay modes:

- Simple - Minimal image information is displayed (refer to **Simple Mode**)
- Basic - Simple plus time sensitive media and battery information (refer to **Basic Mode**)
- Standard - Industry standard image and camera details are displayed (refer to **Standard Mode**)
- Advanced - Standard plus exposure and audio meters (refer to **Advanced Mode**)
- Technical - Advanced plus lens focus distance and monitor look status (refer to **Technical Mode**)

SIMPLE MODE



Simple mode displays the clip name and the current Timecode. When the camera is recording, the Timecode turns red, and a red dot appears in the top right corner.

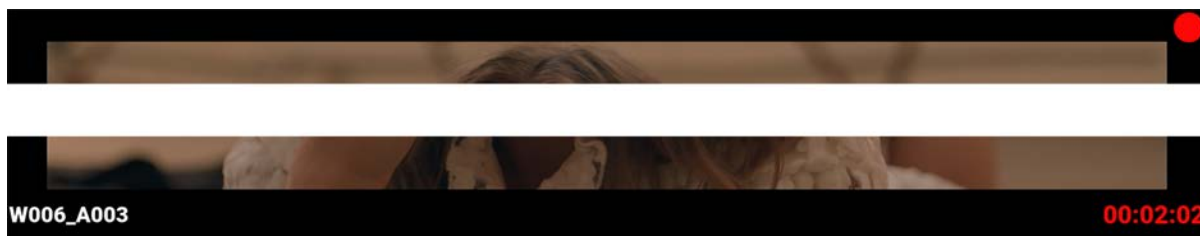

BASIC MODE



Basic mode displays the following:

- Clip Name
- CFexpress Time Remaining (at the current settings)
- Timecode
- Battery percentage remaining (at the current settings)
- DC-IN

When the camera is recording, the Timecode turns red, and a red dot appears in the top right corner.



STANDARD MODE

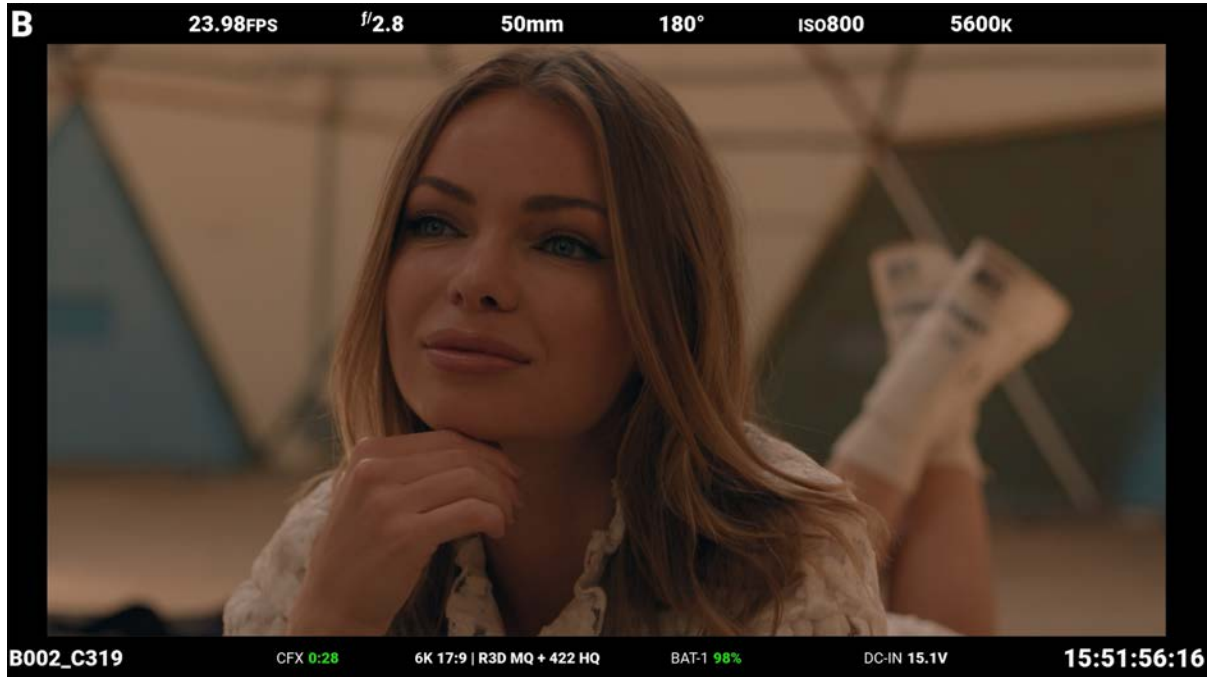

Standard mode displays the following:

TOP	BOTTOM
<ul style="list-style-type: none"> • Camera ID • Recording Frame Rate • f-Stop • Focus Length • Shutter Angle • ISO • White Balance 	<ul style="list-style-type: none"> • Clip Name • CFexpress Time Remaining • Format, File Type, Rate • Battery • DC-IN • Timecode

Lens items such as Focal Length and f-Stop will adaptively display depending on whether the lens data is available. When the camera is recording, the Timecode turns red, and a red dot appears in the top right corner.



ADVANCED MODE



Advanced mode displays the following:

TOP

- Camera Number
- Recording Frame Rate
- f-Stop
- Focus Length
- Shutter Angle
- ISO
- White Balance

BOTTOM

- Clip Name
- Exposure Meter
- Histogram
- CFexpress Time Remaining
- Temperature / Exposure Calibration
- Timecode, Genlock, Synch
- DC-In, Battery
- Format, File Type, Rate
- VU Meter
- Timecode

When the camera is recording, the Timecode turns red, and a red dot appears in the top right corner.



TECHNICAL MODE



Technical mode displays the following:

TOP

- Camera ID
- Recording Frame Rate
- f-Stop
- Focus Length
- Shutter Angle
- ISO
- White Balance
- SDI Look

BOTTOM

- Exposure Meter
- Histogram
- Clip Name
- CFexpress Time Remaining
- Temperature / Exposure Calibration
- Timecode, Genlock, Synch
- Camera Name
- DC-In, Battery
- Format, File Type, Rate
- Timecode
- VU Meter

When the camera is recording, the Timecode turns red, and a red dot appears in the top right corner.

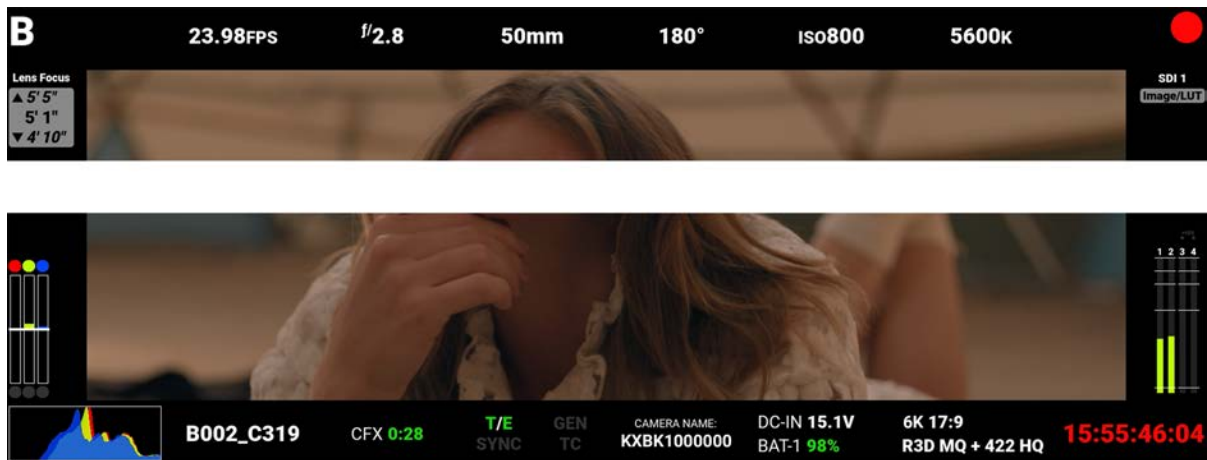

OVERLAY OPACITY

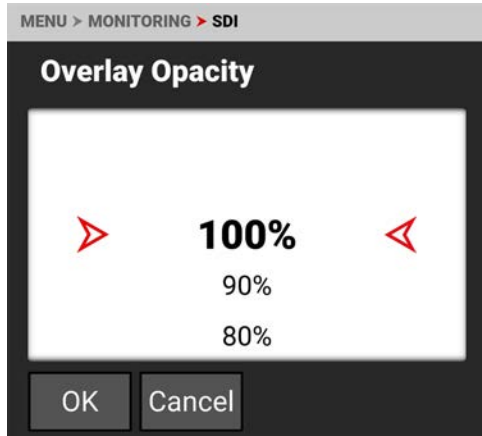

Use Overlay Opacity to select the percentage of opacity you want the overlay to display on the SDI output. The opacity values the camera can display are between 100% and 0%.

FLIP / MIRROR

Use Flip / Mirror to enable or disable the flipped mirrored orientation of the SDI output. Press SEL to toggle between enabled and disabled (default).



SDI PORT DESCRIPTION

The Serial Digital Interface (SDI) port allows the camera to deliver 12 Gbps of image bandwidth with greater resolution, frame rates, and color fidelity. This single BNC cable solution makes it ideal for the 4Kp60 format. The output signal bit depth is 10-bit 4:2:2.

WARNING: Under certain circumstances, it is possible for an SDI connector to incur damage when connected to an accessory and powered without using shielded cables. RED recommends only using high quality, shielded BNC cables that are rated for 12G-SDI signals and only using shielded power cables for powering SDI accessories.

Make sure power is connected to the SDI accessory at all times before you connect the BNC to the camera.

Ungrounded power from SDI accessories can damage the camera's SDI port. To avoid this possible damage, attach the power source to the accessory before attaching it to the BNC cable. When using RED Approved Third Party battery plates, unplug the BNC cable prior to hot swapping.

When possible, avoid using P-Tap (also known as D-Tap) cables to power accessories. To avoid damage when using P-Tap/D-Tap, it's imperative that the connect/disconnect sequence (below) is followed precisely.

BNC ATTACHMENT INSTRUCTIONS

When attaching SDI accessories:

1. Connect a power source to the SDI accessory; power on the SDI accessory.
2. Ensure a power source is connected to the camera. This ensures both are grounded prior to connecting the BNC. The camera's power state does not have an impact on SDI attachment sequence.
3. Connect the BNC cable to the accessory, then to the camera.

When detaching an accessory mounted to an SDI output, ensure that you remove the BNC connection to the camera before removing power to the SDI device:

1. Shutdown the SDI accessory.
2. Disconnect the BNC cable from the camera.
3. Disconnect the power source from the SDI accessory.

When you need to swap out a battery on an accessory mounted to the camera's SDI port, you must:

1. Shutdown the SDI accessory.
2. Disconnect the BNC cable from the camera.
3. Replace the battery on the SDI accessory.
4. Connect the BNC cable to the camera.
5. Power on the SDI accessory.

For more information, refer to [Preventing Damage to SDI Outputs](#).



For more information about the SDI standard, refer to the SMPTE (Society of Motion Picture and Television Engineers) standard SMPTE ST-2082.

LIVE STREAM

Use Live Stream to enable or disable live streaming over Wi-Fi. The Live Stream image is controlled by the LCD monitoring tools (the Guides are not displayed). Refer to [Monitoring Tools](#) for more information.

NOTE: When live streaming, select 5 GHz as the Wi-Fi band (refer to [Ad-Hoc](#)).

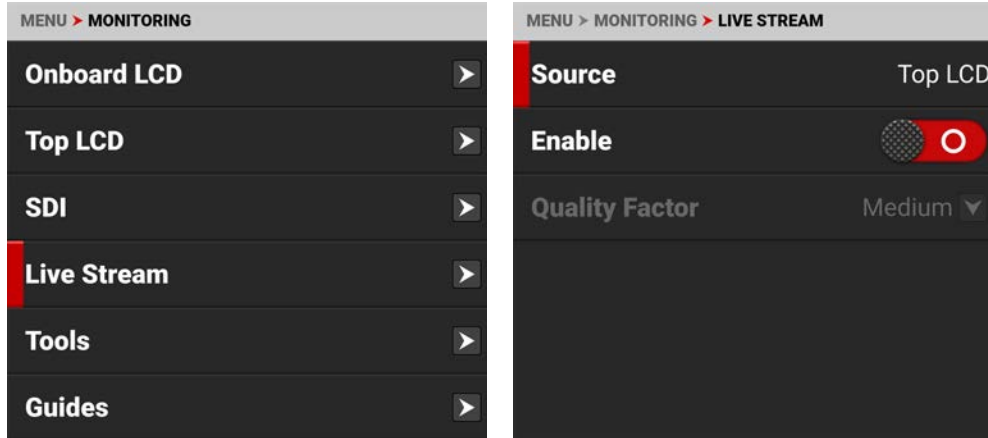

SOURCE

Source displays the source of the Live Stream image. Live stream displays the looks, tools, and magnification enabled for that source.

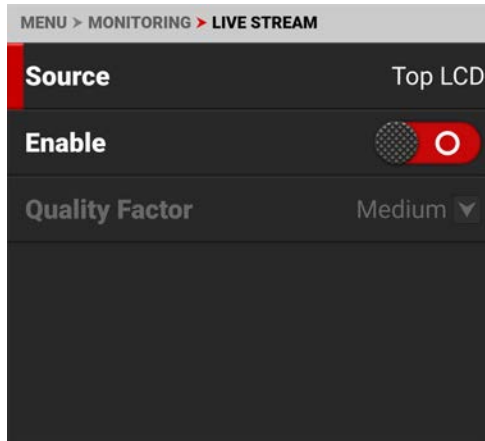

ENABLE

Use Enable to enable or disable (default) the Live Stream feature.



QUALITY FACTOR

Use Quality Factor, when Live Streaming is enabled, to control the video quality the camera's output stream. Lower quality can stream over a longer distance.

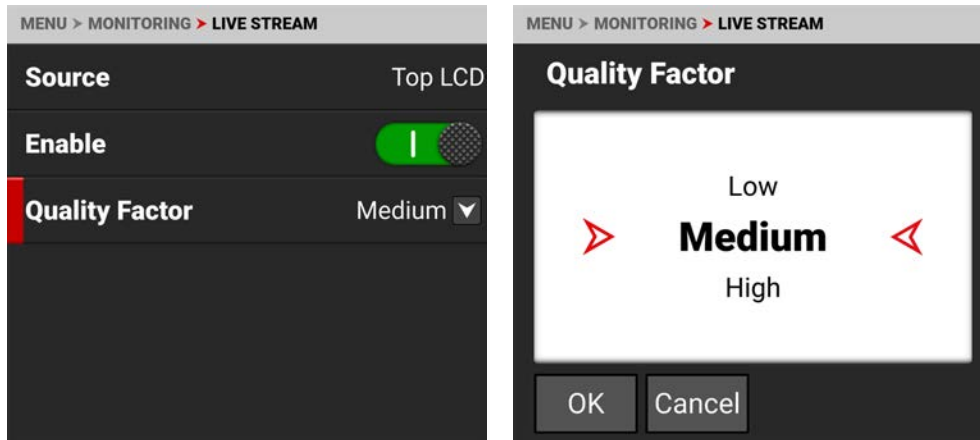

TOOLS

The Tools menu provides access to the monitoring tools you use to monitor image exposure and focus.

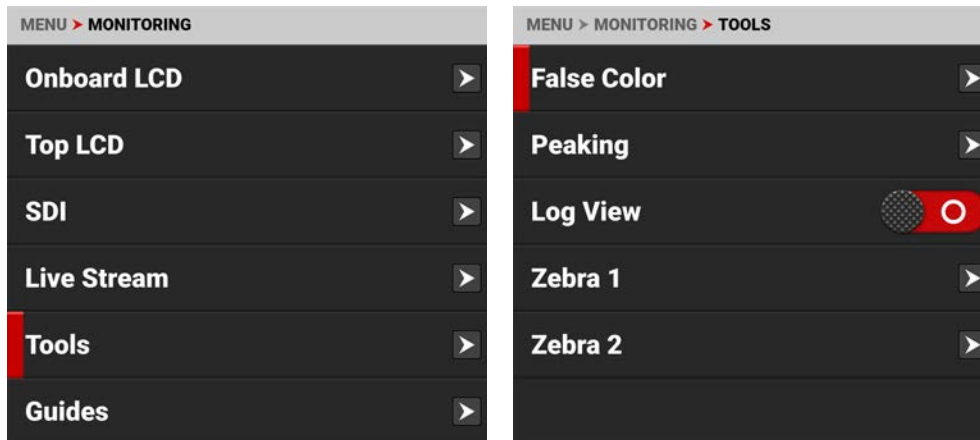

The monitoring tools that you can use include:

ITEMS	DETAILS
False Color	Enable and configure the False Color Exposure Mode , False Color Video Mode , and the False Color Video Mode
Peaking	Enable and configure focus indicating modes
Log View	Enable or disable (default) Log View
Zebra 1	Enable and configure Zebra 1 settings
Zebra 2	Enable and configure Zebra 2 settings

FALSE COLOR

Use False Color to configure the False Color tool settings.

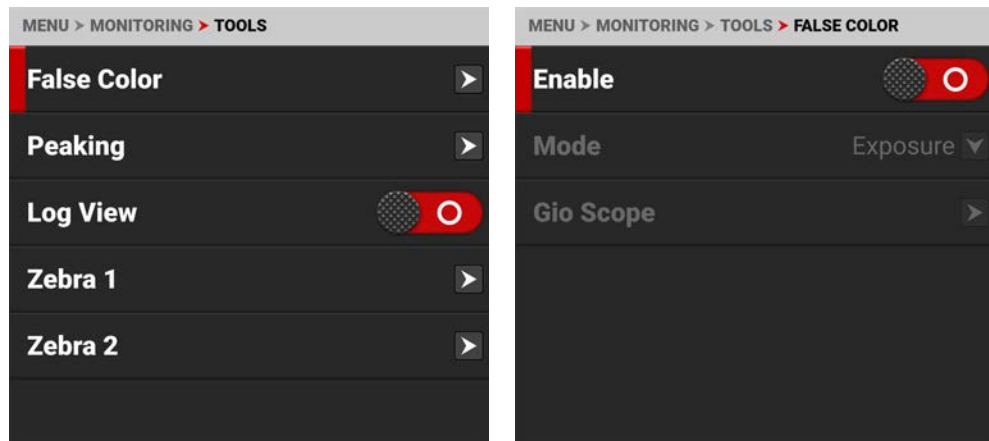

The False Color tool settings you can configure include:

ITEMS	DETAILS
Enable	Enable or disable the False Color tool modes
False Color Mode	Select the False Color tool mode
False Color Gio Scope Mode	Identify 16+ increments within the dynamic range of the RAW sensor image.

ENABLE

Use Enable to enable or disable the False Color tool.



FALSE COLOR MODE

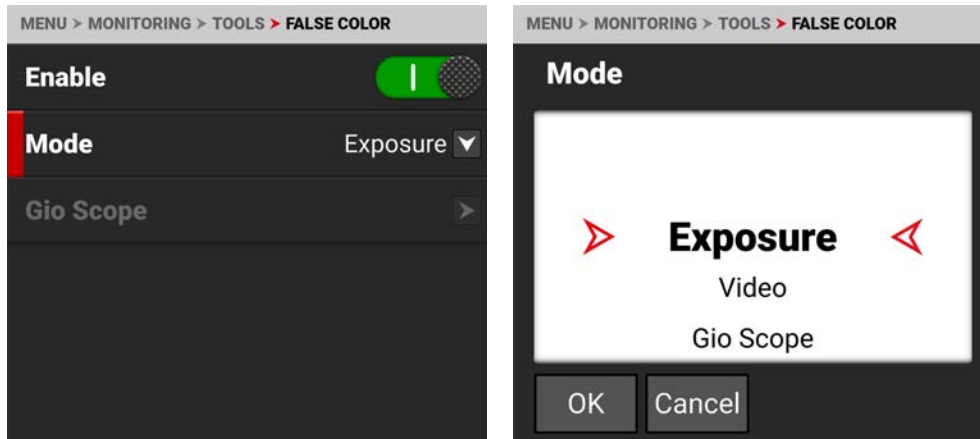

False Color Modes include:

ITEMS	DETAILS
False Color Exposure Mode	Use false colors to determine an optimal balance between overexposure and underexposure.
False Color Video Mode	Access scene exposure in varying light without relying on the LCD image brightness.
False Color Gio Scope Mode	Identify 16+ increments within the dynamic range of the RAW sensor image.

NOTE: False Color modes display on video recorded through SDI to an external recorder when the Tools are enabled in the Monitor menu. When recording through SDI, use False Color modes only to help determine scene exposure settings, and then disable the mode before recording.

FALSE COLOR EXPOSURE MODE

When this monitoring **False Color** mode is activated, most of the tonal range will appear in monochrome.

The Exposure Mode is able to indicate exactly where middle gray is falling, and indicate which highlights or shadows are problematic in the logarithmic representation of the image. Exposure mode is judging the exposure after ISO and White Balance adjustments are made, and before any sort of LUT or transform is applied to the Log3G10 image.

RED FALSE COLOR OVERLAY

When the False Color Mode overlays the color red within the subject of interest, or anywhere except bright lights and direct reflections, then the image is likely overexposed. When the False Color Mode does not overlay the color red on the image, then the exposure is likely okay for the selected ISO.

PURPLE FALSE COLOR OVERLAY

When the False Color Mode overlays the color purple on key image detail that is not located in the shadows, then the scene is likely underexposed. When the False Color Mode does not overlay the color purple on the image, then the exposure is likely okay for the selected ISO.

For more information, refer to **Exposure** in the How To section.

FALSE COLOR VIDEO MODE

NOTE: For best results, Video Mode should be viewed at or above ISO 800.

Video Mode displays a color overlay that indicates the video level of the RGB monitor path (calibrated to the SMPTE test signal).

The colors used are based on the RGB levels of the video out signal (that is, the “cooked” look, and not RAW data). The camera's RGB settings can change the appearance of the Video Mode colors.

The Video Mode colors represent the following IRE values (at all other values, the desaturated image represents the luminance value of the ISO adjusted image):

- Purple: IRE 0–4
- Blue: IRE 5
- Teal: IRE 10–12
- Green: IRE 41–48
- Pink: IRE 61–70
- Straw: IRE 92–93
- Yellow: IRE 94–95
- Orange: IRE 96–98
- Red: IRE 99–100

For more information, refer to [Exposure](#) in the How To section.

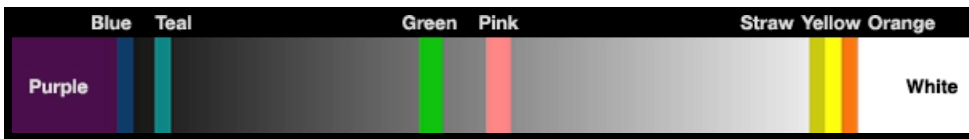

Green is where you will want 18% gray, Pink is typically the brightness of Caucasian skin tones, Straw, Yellow, and Orange are strong highlights and increasingly closer to white, Teal is deep shadows and Blue is on the verge of becoming untextured black. In general, Pink and Green are most helpful when calibrating based on a known reference, whereas the other colors indicate the extremes of a tonal range.

A potential disadvantage of False Color Video mode is that all the false colors can distract from the underlying preview. Many prefer to use this mode only during initial set-up, and then they use [False Color Exposure Mode](#) under a wider range of scenarios.

IN PRACTICE

In [False Color Exposure Mode](#), use the purple and red indicators to adjust your lighting or lens aperture. Use this strategy to achieve an optimal balance between clipping from overexposure and image noise from underexposure. With most scenes, you can often have a surprising range of exposure latitude before excessive red or purple indicators begin to appear.

If necessary, use False Color Video mode or [Zebra Modes](#) to fine-tune how the scene will appear over SDI, or use it to adjust your suggested look when sending footage for post-production.

The Zebra and Video modes are also an objective way to assess the scene exposure under varying ambient light without relying on the LCD image to evaluate brightness.

FALSE COLOR GIO SCOPE MODE

Gio Scope mode displays a color overlay on top of a desaturated RAW sensor image, identifying 16 increments within the dynamic range of the sensor. The RGB settings (color temperature, ISO, LUT, etc.) are not used by this mode.

Each number (1 to 16) indicates a different increment of dynamic range. Number 16 represents the top increment, and is broken up into 1/8th sub-increments to show highlight roll-off. Each 1/8th increment is represented by a different shade of red, ranging from light red (less light) to dark red (most light, clipping).

PEAKING

The Peaking tools display contrast, outlines, or colors to assist with focusing.

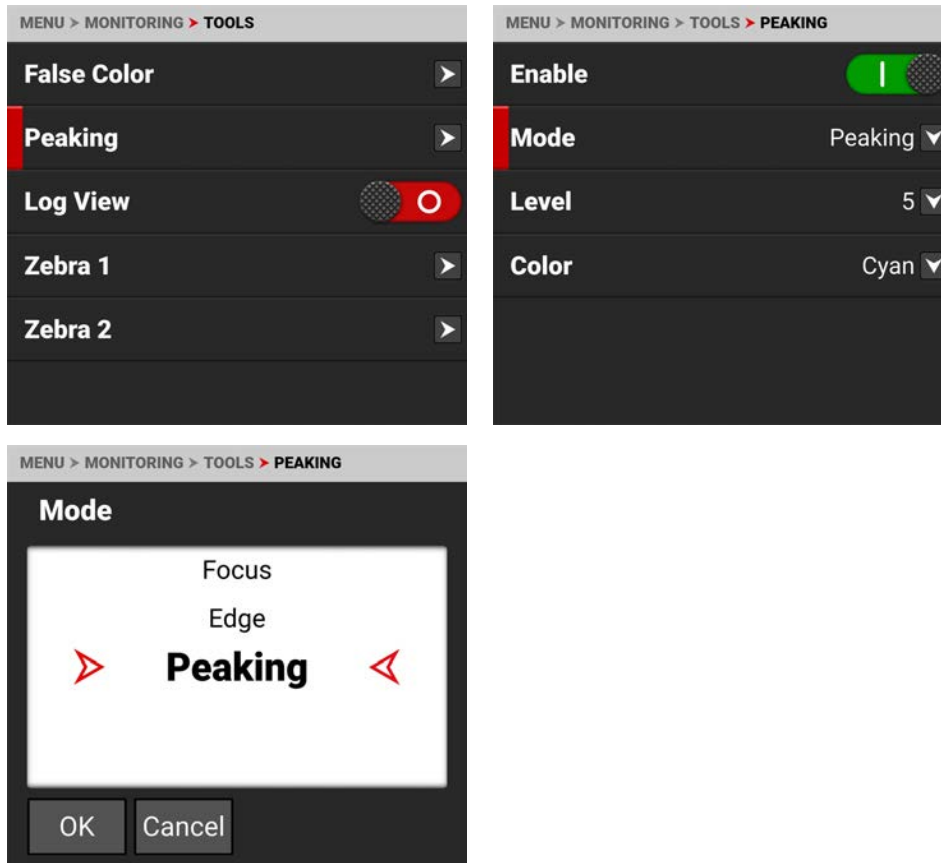

The Peaking modes you can use include:

ITEMS	DETAILS
Focus	Use enhanced contrast and edges for focusing
Edge	Show outlines of focused objects
Peaking	Select a colored overlay to indicate objects in focus

FOCUS PEAKING MODE

Focus Peaking mode emphasizes contrast and edges in the image without changing the brightness or the image content. This mode makes it easier to judge focus. Adjust the zoom and focus to easily see which objects are coming into focus.

EDGE PEAKING MODE

When you enable Edge Peaking mode, the display shows the edges or outlines of objects that are in focus.

PEAKING PEAKING MODE

The Peaking Peaking mode displays a color overlay on top of in-focus edges. Select a Level of 1 to 10 (weak to strong) for the intensity of the color overlay. The RGB settings can change the appearance of the selected color overlay.

The Peaking Peaking mode indicator is applied after the image is scaled to a monitor, making the indicators appear differently on various monitors.

For more information about Peaking, refer to **Focus** in the How To section.

LOG VIEW

Use Log View to display camera images in REDWideGamutRGB and Log3G10 for the ISO, Exposure Adjust, Color Temperature, and Tint settings. This allows you to quickly see ungraded footage that remains unaffected by creative decisions such as the choice of 3D LUT or CDL.

Log View is passed through the SDI port when recording to an external recorder. You can view the Log image in playback on the LCD and on the monitor. However, Log View is not recorded to the file recorded on the media card.

NOTE: Log View is only enabled on R3D files and not on ProRes files.

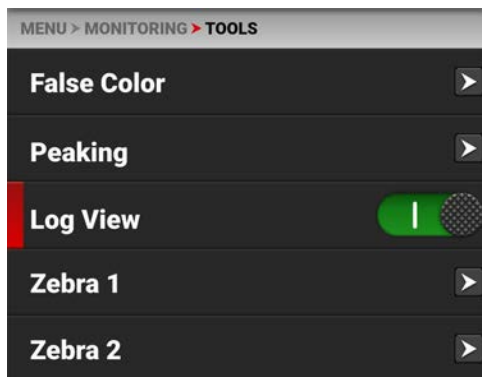

Use the toggle to switch from Enabled to Disabled:



ZEBRA 1

Use Zebra 1 to display one set of diagonal stripes to indicate highlight exposure levels. For more information, refer to [Zebra Modes](#).

Zebra 1 is disabled by default.

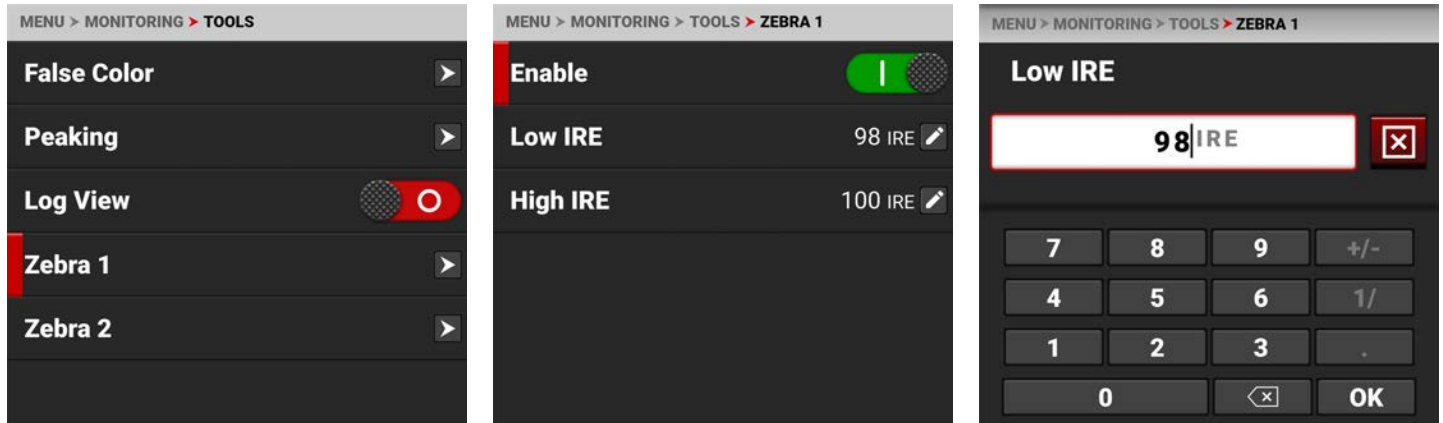

The Zebra 1 mode includes:

ITEMS	DETAILS
Enable	Enables red zebra stripes to indicate highlight exposure
Low IRE	Sets the lower threshold for the indicator
High IRE	Sets the higher threshold for the indicator

ENABLE

The Enable toggle switch allows you to enable or disable the Zebra 1 stripes.

LOW IRE

Provides a keypad that allows you to set the low threshold for the Zebra stripe. The default setting is 98 IRE.

HIGH IRE

Provides a keypad that allows you to set the high threshold for the Zebra stripe. The default setting is 100 IRE.

NORMAL VIEW

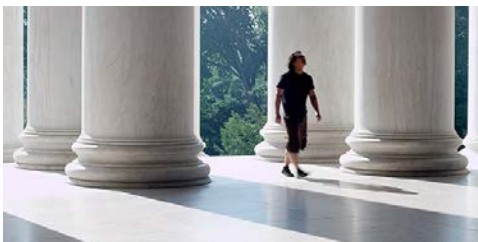

ZEBRA 1 VIEW

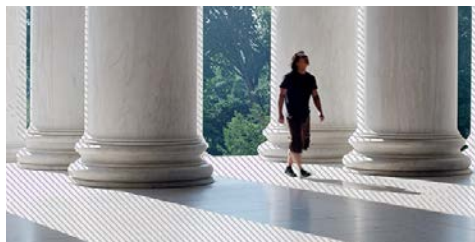

ZEBRA 2

Use Zebra 2 to display a second set of diagonal stripes to indicate mid-tone and shadow levels. For more information, refer to [Zebra Modes](#).

Zebra 2 is disabled by default.

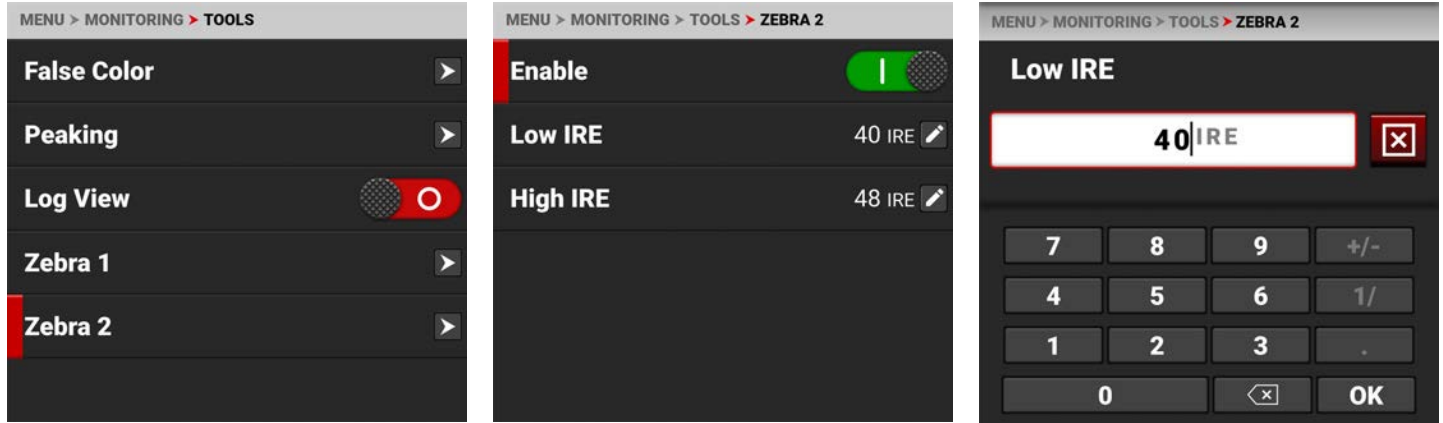

The Zebra 2 mode includes:

ITEMS	DETAILS
Enable	Enables green zebra stripes to indicate mid-tone and shadow exposure
Low IRE	Sets the lower threshold for the indicator
High IRE	Sets the higher threshold for the indicator

ENABLE

The Enable toggle switch allows you to enable or disable the Zebra 2 stripes.

LOW IRE

Provides a keypad that allows you to set the low threshold for the Zebra stripe. The default setting is 40 IRE.

HIGH IRE

Provides a keypad that allows you to set the high threshold for the Zebra stripe. The default setting is 48 IRE.

NORMAL VIEW

ZEBRA 1 VIEW

ZEBRA 2 VIEW

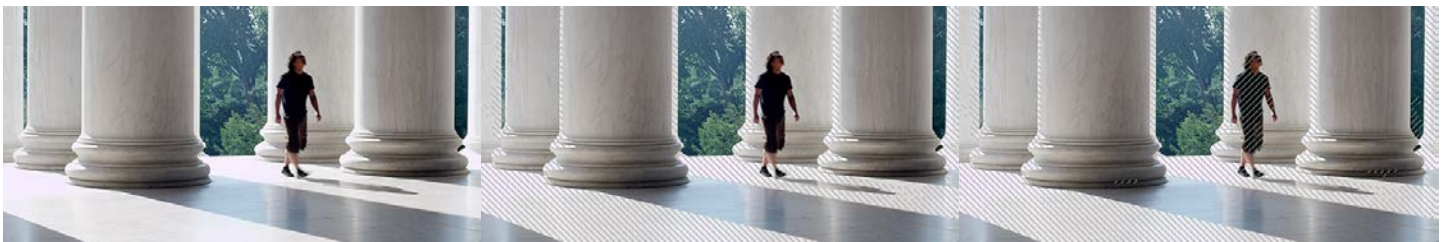

GUIDES

Use Guides to enable and configure the camera's monitoring guides.

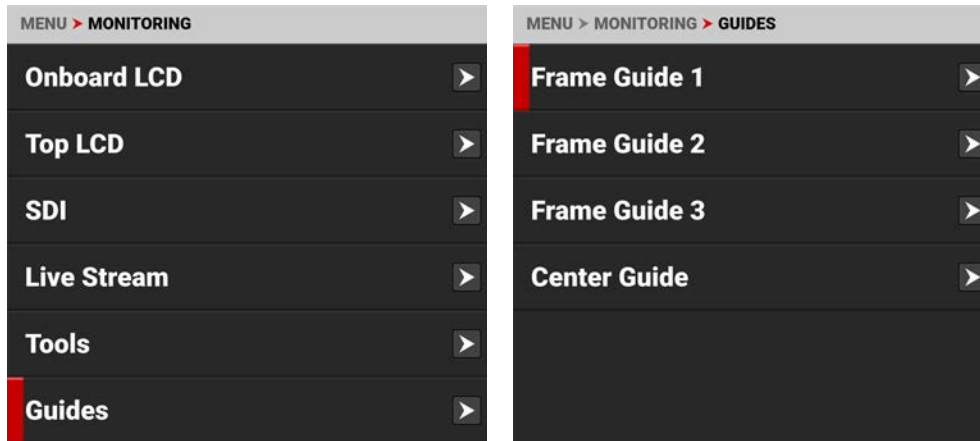

The monitoring Guides that you can use include:

ITEMS	DETAILS
Frame Guides	Guides you can configure to aid in framing a shot
Center Guide	A center cross hair or dot you can use to center your shot

FRAME GUIDES

Use Frame Guides to frame the scene using various shapes and sizes. You can configure up to 3 Frame Guides to display on your monitor.

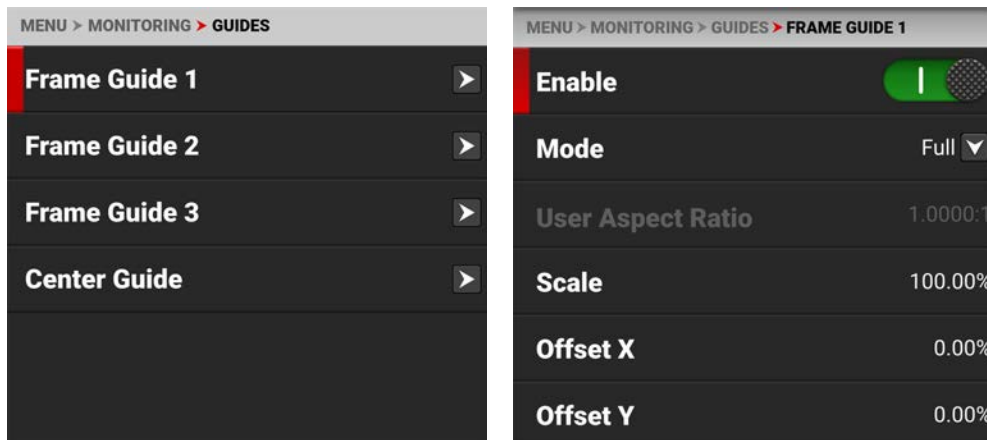

Configure the Frame Guides using the following:

ITEMS	DETAILS
Enable	Enables the Frame Guide
Mode	Select aspect ratios, User, and Absolute modes
User Aspect Ratio	Enabled by selecting User mode
Scale	Percentage of the image the Frame Guide occupies
Offset X, Y	Percentage of horizontal and vertical offset
Absolute X, Y, W, H	Absolute mode - set the exact number of size and offset pixels

ITEMS	DETAILS
Line Style	Select the Frame Guide line type - solid, dashed or bracket
Line Color	Select the Frame Guide line color
Line Opacity	Select the Frame Guide line opacity percentage
Shade Outside	Enables shading outside of the Frame Guide
Shade Color	Select the shading color
Shade Opacity	Select the shading opacity

MODE

Use Mode to select the Frame Guide mode you want to use to configure the frame guide.

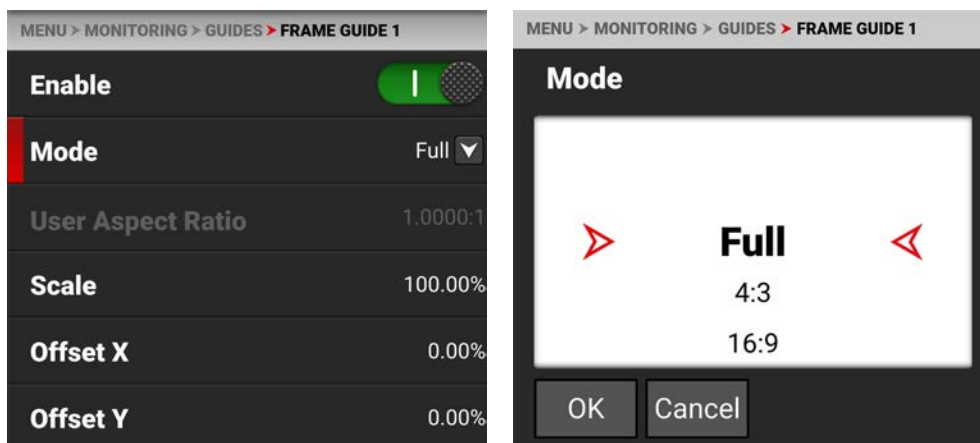

The modes you can select include aspect ratios from Full to 2.4:1, User, and Absolute. The User and Absolute modes enable settings that are specific to those modes.

USER ASPECT RATIO

This item is enabled when the User mode is selected.

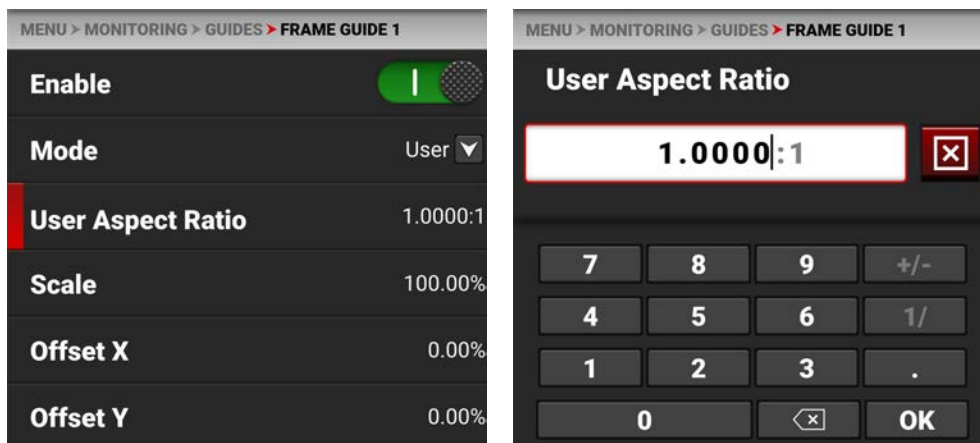

Use the keypad to enter your desired aspect ratio.

SCALE

Use scale to configure the percentage of the image area that the Frame Guide will frame.

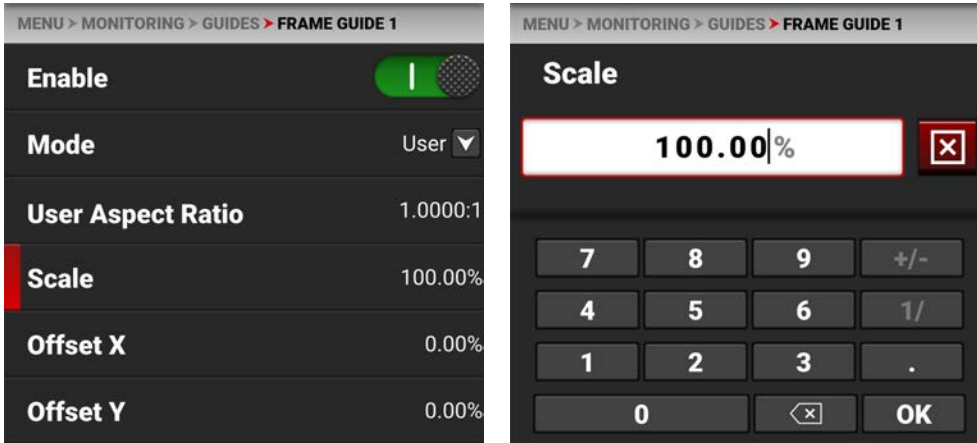

Use the keypad to enter the percentage of the image the Frame Guide contains.

OFFSET X, Y

Use offset to configure the X and Y offset of the Frame Guide.

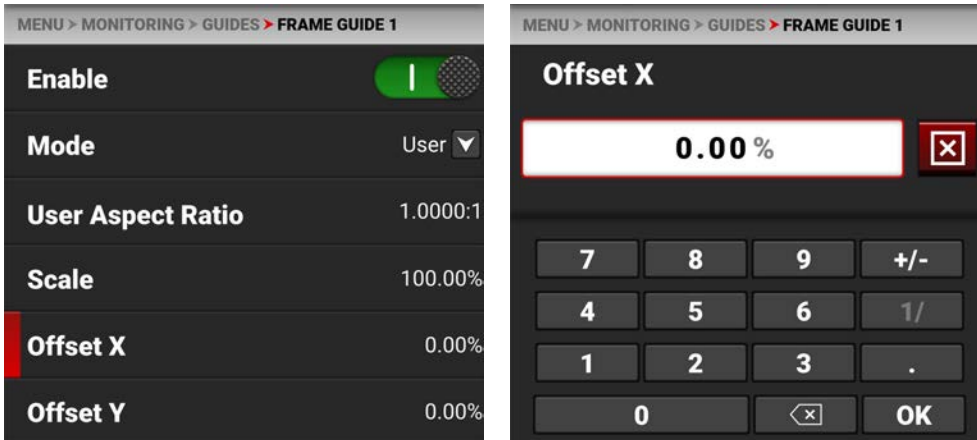

Use the keypad to enter the percentage of offset from center you want to apply to the Frame Guide.

ABSOLUTE X, Y, W, H

Use the Absolute settings to configure the absolute dimensions and position of the Frame Guide.

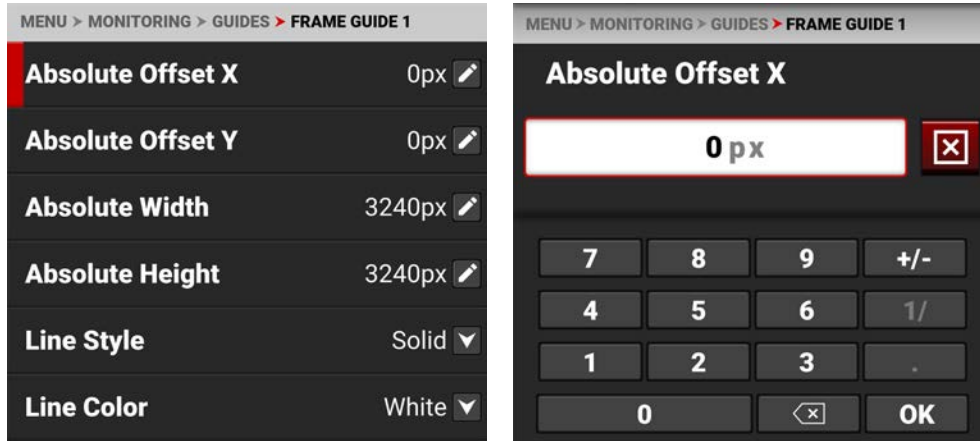

Use the keypad to enter the number of pixels for X/Y offset and for the width and height of the Frame Guide. The Absolute items are only enabled when you select Absolute **Mode**.

LINE STYLE

Use Line Style to select the type of line the Frame Guide uses.

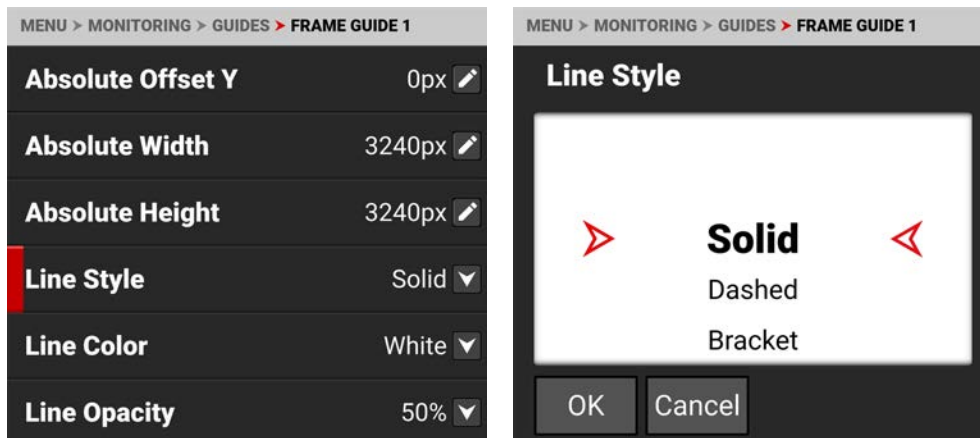

Select Solid (default), Dashed, or Bracket for the Frame Guide line style.

LINE COLOR

Use Line Color to select the color of the Frame Guide line.

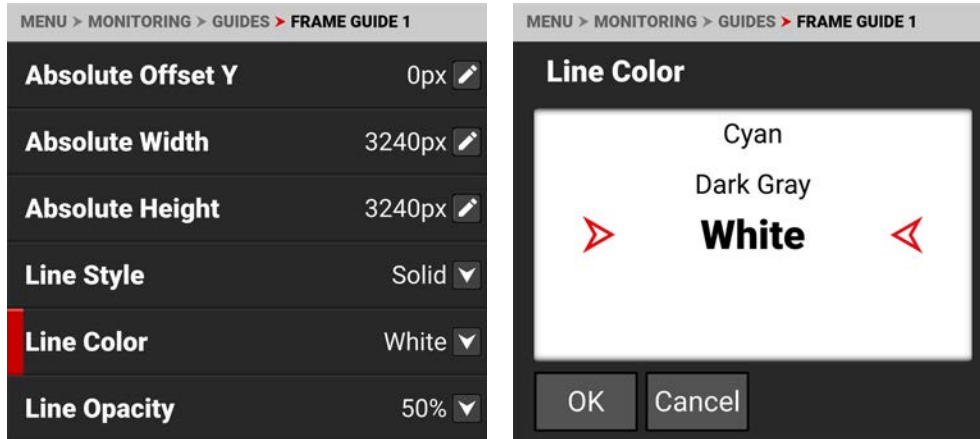

Use Line Color to select one of the following colors for the Frame Guide line:

- Black
- Red
- Blue
- Green
- Yellow
- Magenta
- Cyan
- Dark Gray
- White (default)

LINE OPACITY

Use Line Opacity to select how transparent the Frame Guide line appears.

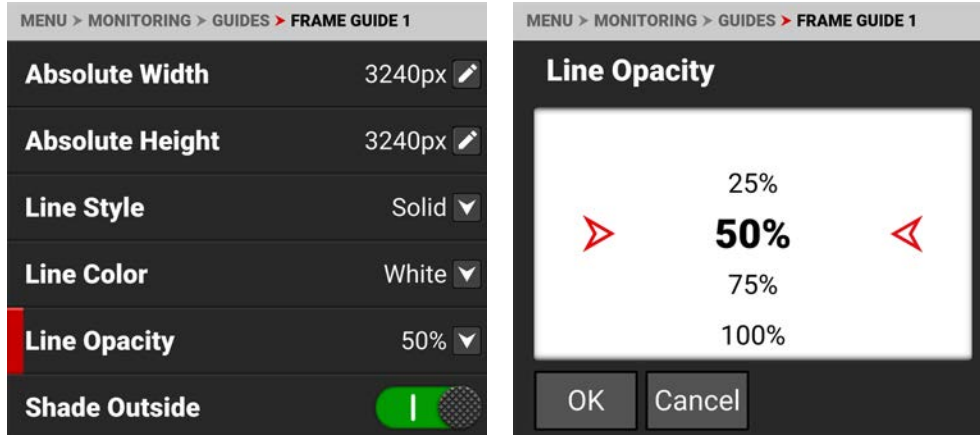

Use Line Opacity to select the percentage of opacity for the Frame Guide line:

- 25%
- 50% (default)
- 75%
- 100%

SHADE COLOR

Use Shade Color to select the color of shading to use outside of the Frame guide.

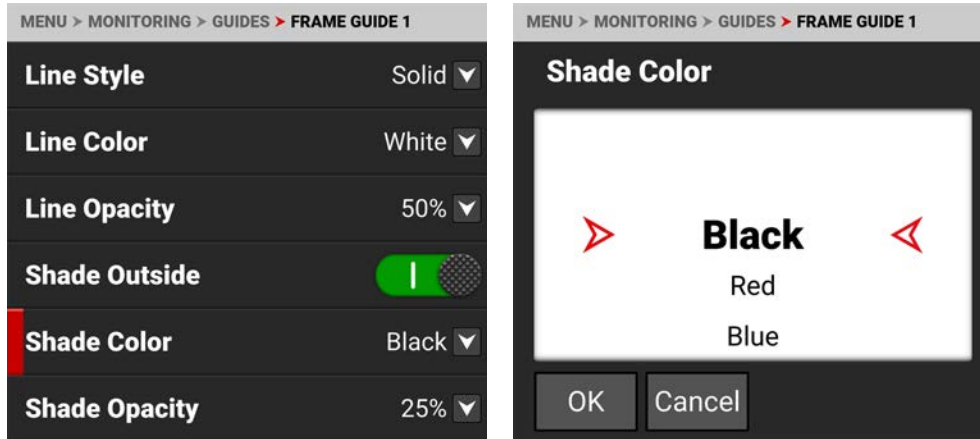

Use Shade Color to select one of the following colors for the outside shading:

- Black (default)
- Red
- Blue
- Green
- Yellow
- Magenta
- Cyan
- Dark Gray
- White

SHADE OPACITY

Use Shade Opacity to select the opacity of the shading outside of the Frame guide.

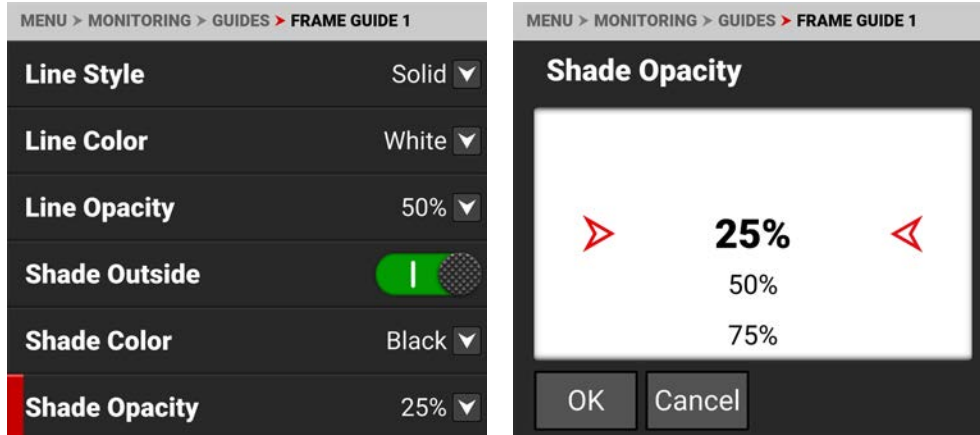

Use Shade Opacity to select the percentage of opacity for the shading outside of the Frame Guide:

- 25% (default)
- 50%
- 75%
- 100%

CENTER GUIDE

Use Center Guide to enable and configure the Center Guide.

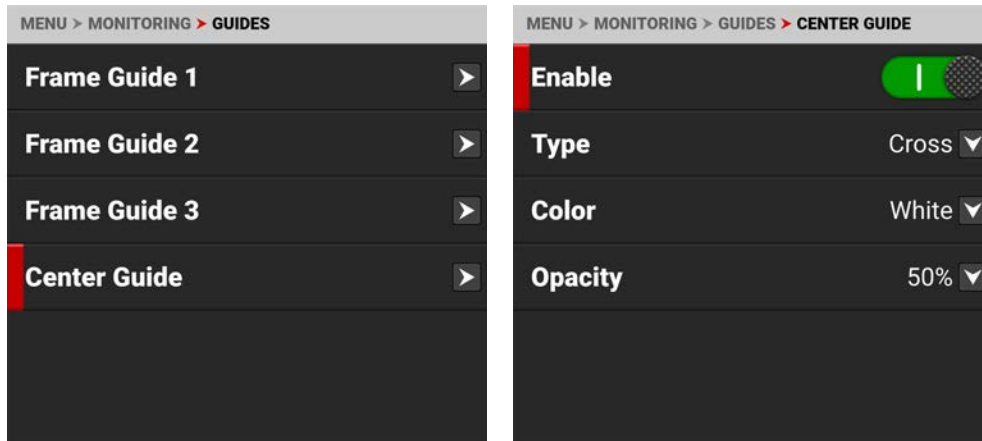

Configure the Center Guide by using the following:

ITEMS	DETAILS
Enable	Enables the Center Guide
Type	Select Center Guide type - dot or cross
Color	Select a color for the Center Guide
Opacity	Percentage of opacity of the guide color

TYPE

Use Type to select the type of Center Guide to display.

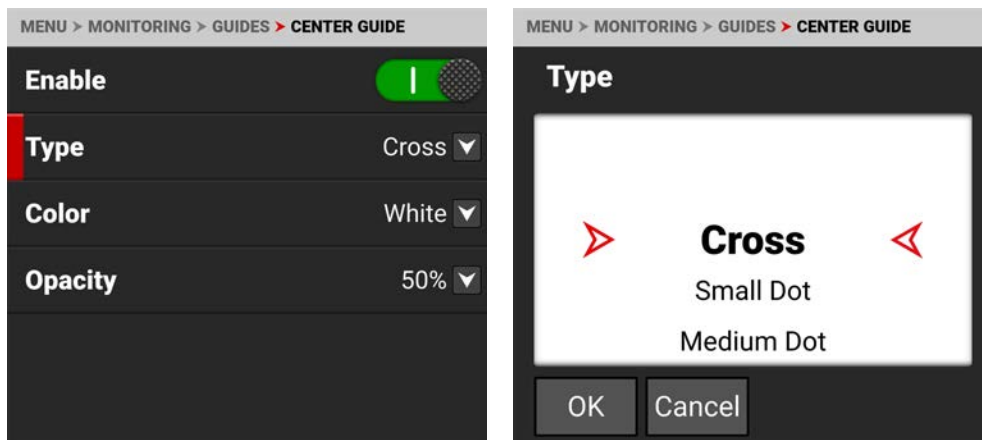

Use Type to select a center dot or cross (default) for the Center Guide.

COLOR

Use Color to select the color used by the Center Guide.

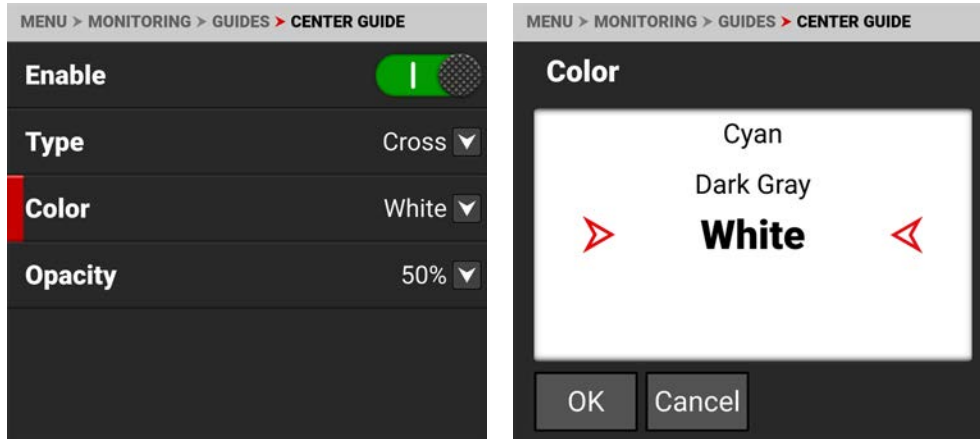

Use Color to select one of the following colors for the Center Guide:

- Black
- Green
- Cyan
- Red
- Yellow
- Dark Gray
- Blue
- Magenta
- White (default)

OPACITY

Use Opacity to select how transparent the Center Guide appears.

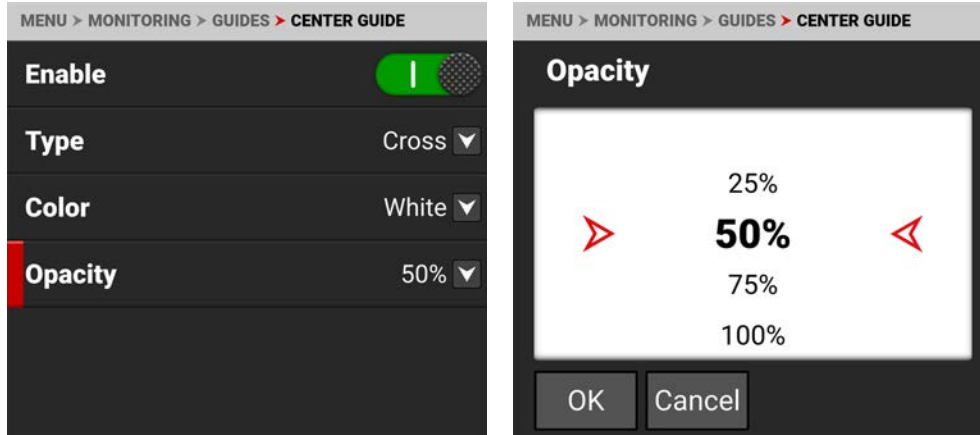

Use Opacity to select the percentage of opacity for the Center Guide:

- 25%
- 50% (default)
- 75%
- 100%

MEDIA MENU

The Media menu contains the settings you use to configure your media.

From the Onboard LCD touchscreen menu, tap Media:

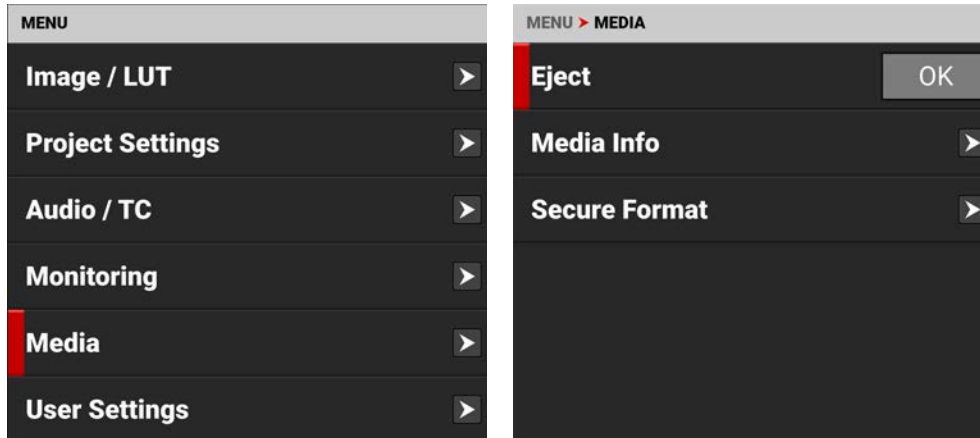

Use the Media menu to configure the camera's storage media settings and to view the media information:

ITEMS	DETAILS
Eject	Eject the media card
Media Info	View the media card information
Secure Format	Performs a secure format of the media card

EJECT

Use Eject to safely unmount the media card electronically from the camera before removing it physically.

WARNING: The media can get extremely hot. Use caution when removing media.

WARNING: Do not attach a label to the media card. The heat generated by the media can weaken the label's adhesive, causing the label to detach inside of the camera. Labels can also diminish heat dissipation and cause excessive wear to the internal components. Removing a label from a media card can possibly deform the card body.

Access Eject from the [Onboard LCD Touchscreen](#) Media menu:

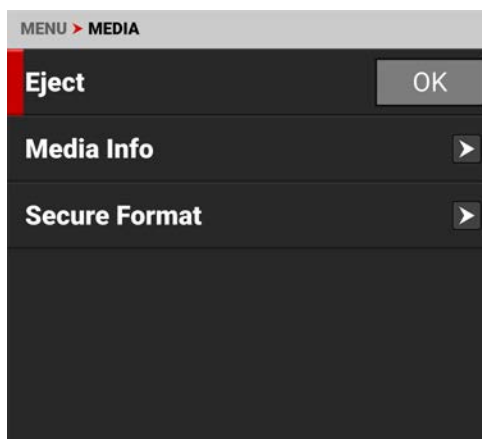

For more information, refer to [Media Management](#).

MEDIA INFO

Use Media Info to display the media card information.

Access Media Info from the **Onboard LCD Touchscreen** Media menu:

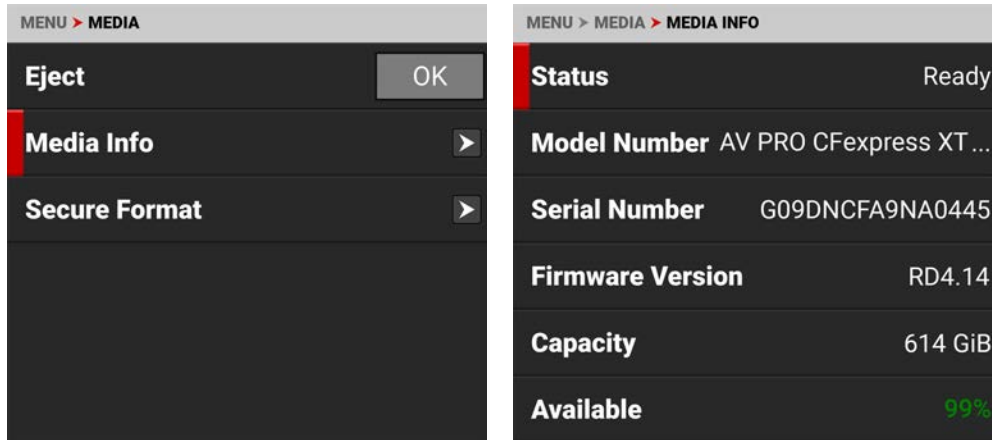

Media Info displays the following:

SETTING	DETAILS
Status	Displays the media card status
Model Number	Displays the media card model number
Serial Number	Displays the media card serial number
Firmware Version	Displays the media card firmware version
Capacity	Displays the media card total capacity
Available	Displays the media card's remaining storage
Time Remaining	Displays the recording time remaining on the media card

SECURE FORMAT

Use Secure Format to format the media card down to the file system level.

A secure format allows you to rebuild the card file system.

WARNING: Secure Format permanently deletes all information from the media card. Data cannot be recovered after a Secure Format.

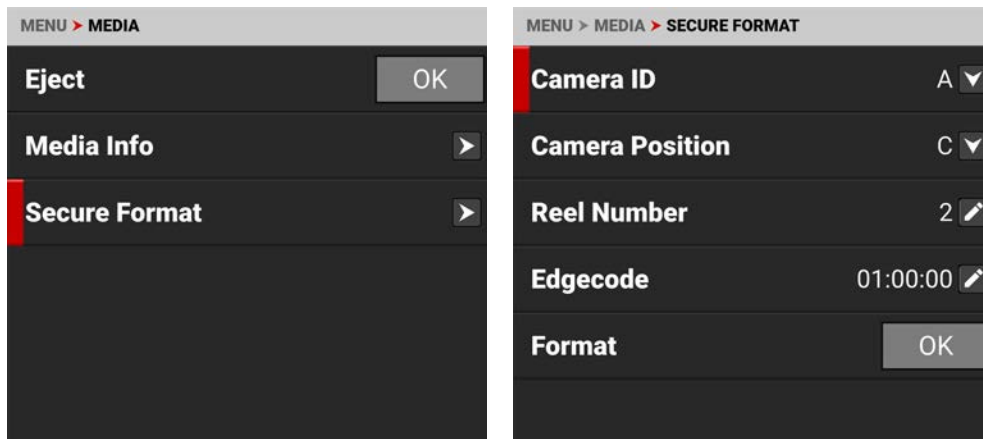

Use the Secure Format menu to update the following information:

SETTING	DETAILS
Camera ID	Select the camera ID (default is A)
Camera Position	Select the camera position (default is C)
Reel Number	Select the reel number (default is 1)
Edgecode	Enter the time number (default is 01:00:00)
Format	Starts the Secure formatting process

For more information, refer to [Secure Format](#).

CAMERA ID

Use Camera ID to assign a camera ID letter to the media.

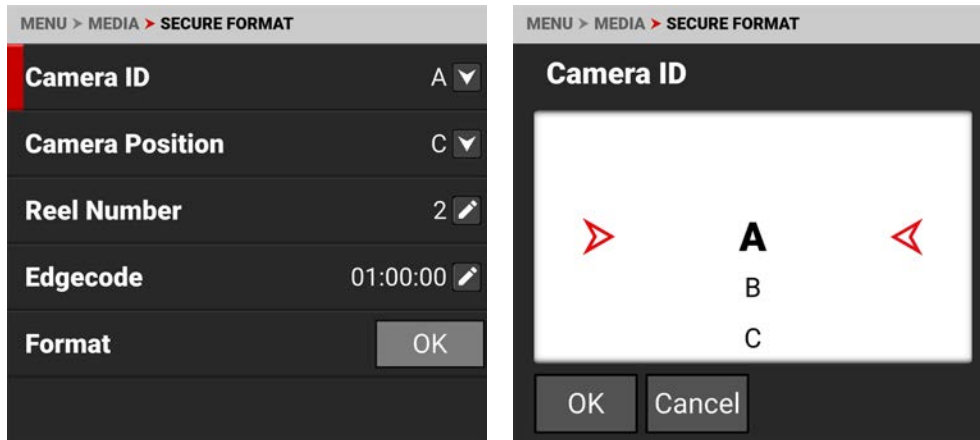

The Camera ID letters you can assign range from A-Z. For more information, refer to [Secure Format](#).

CAMERA POSITION

Use Camera Position to select the camera position label for the media card.

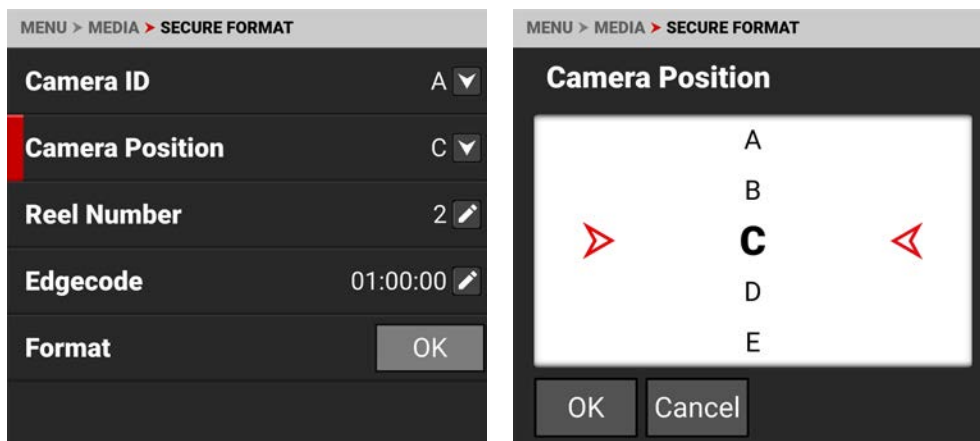

The Camera Position letters you can assign range from A-Z. For more information, refer to [Secure Format](#).

REEL NUMBER

Use Reel Number to assign a reel number to the media.

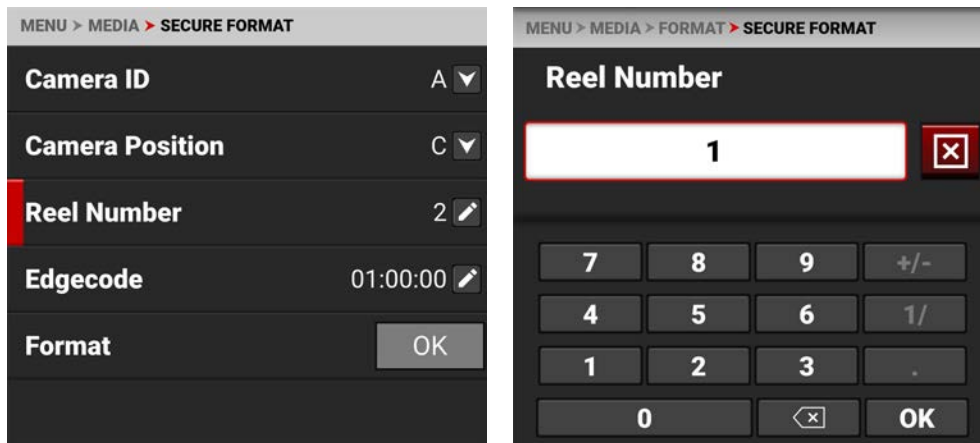

Use the keypad to enter a unique reel number to the media.

NOTE: It is best practice to keep your reel numbers to no longer than seven characters in length to conform with all edit decision list (EDL) formats.

For more information, refer to [Secure Format](#).

EDGECODE

Use Edgecode to assign an edgecode to the media.

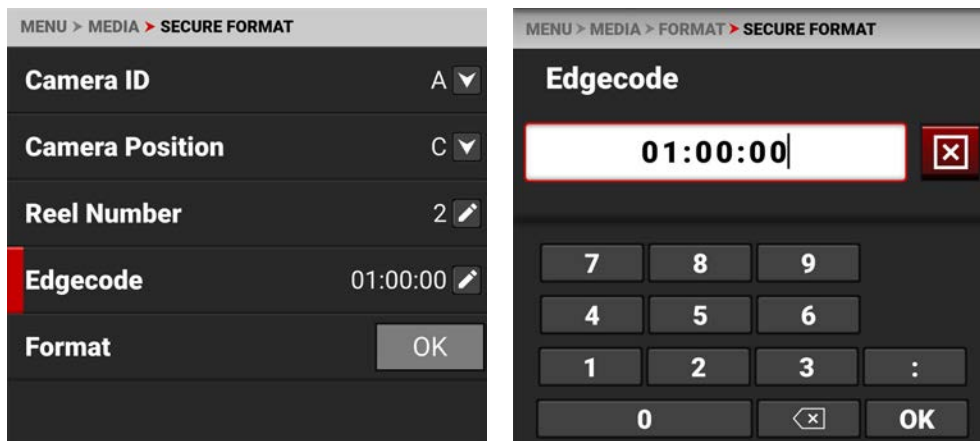

Use the keypad to enter a unique edgecode number to the media.

Edgecode is a SMPTE Timecode track, which by default starts at 01:00:00 on the first frame of each media card. It is a sequential code that is continuous from frame to frame and also between clips. Edgecode is equivalent to RUN RECORD as used on broadcast cameras.

For more information, refer to [Secure Format](#).

FORMAT

Use Format to execute a secure format of the media.

WARNING: Formatting permanently deletes all information from the media card. Data cannot be recovered after a format.

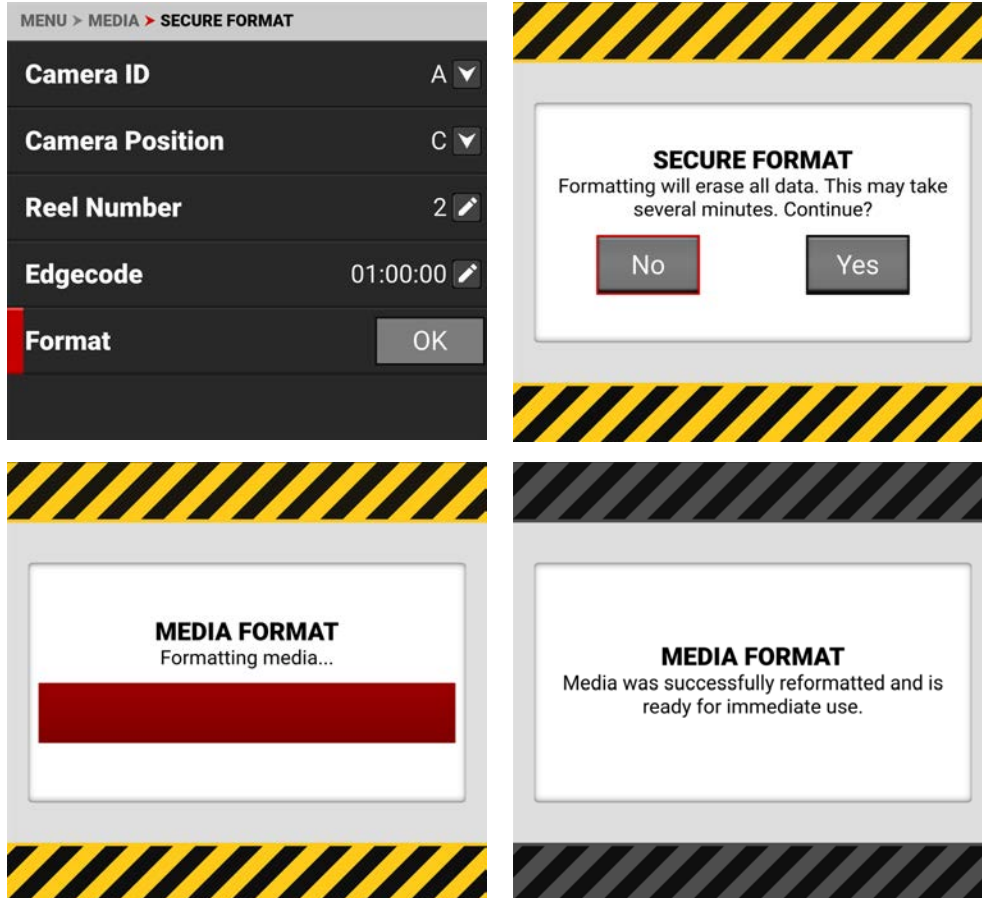

For more information, refer to [Secure Format](#).

USER SETTINGS MENU

The User Settings menu contains the settings you use to create presets and assign User button functions. From the Onboard LCD touchscreen menu, select User Settings:

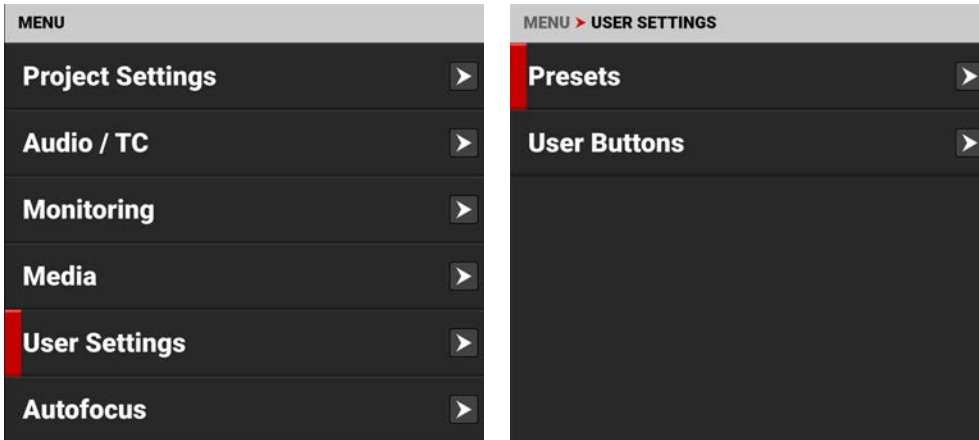

Use the User Settings menu to configure presets and User buttons:

ITEMS	DETAILS
Presets	Configure and manage presets
User Buttons	Assign functions to the user buttons

PRESETS

Use Presets to build and select pre-configured settings for the camera.

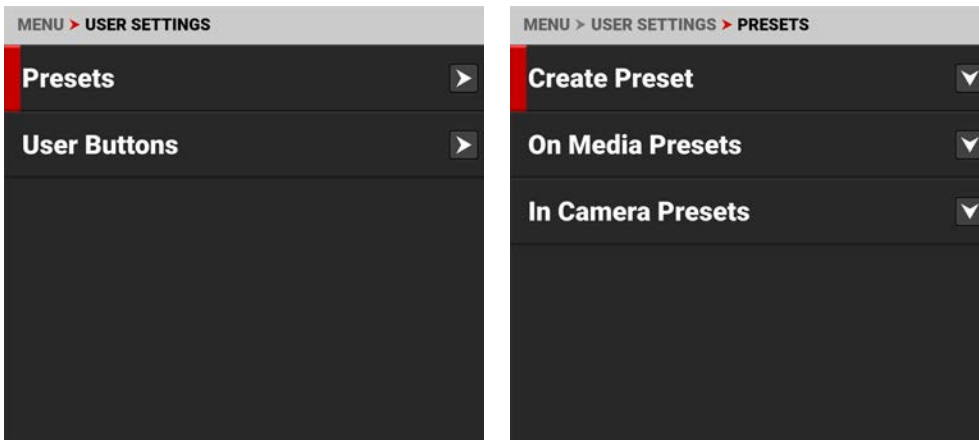

The Presets menu contains the following:

ITEMS	DETAILS
Create Preset	Create camera setting presets
On Media Presets	Manage presets stored on the media
In Camera Presets	Manage presets stored in the camera

CREATE PRESET

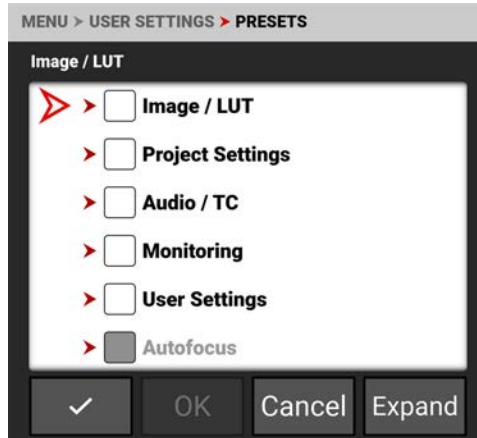
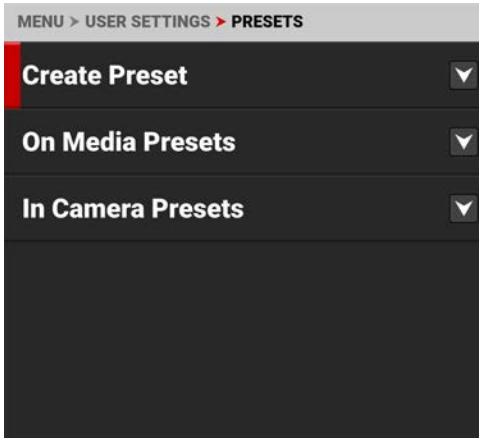

Use Create Preset to select the current camera settings you want to use to create a preset list of settings. You can select settings individually:

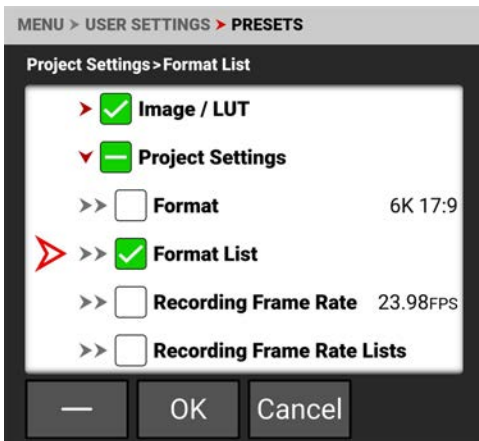

You can also use the menu checkmark button to select all of a menu's settings as a preset:

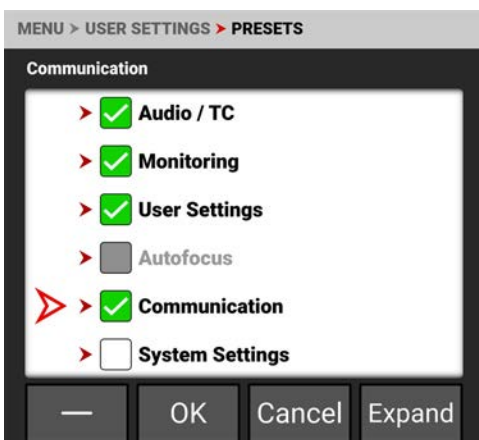

Click OK to create the preset. The Create Preset screen opens. Enter your Preset name and tap OK. The Preset is saved to the camera.



Enter your Preset name and tap OK. The Preset is saved to the camera (refer to [In Camera Presets](#)).



ON MEDIA PRESETS

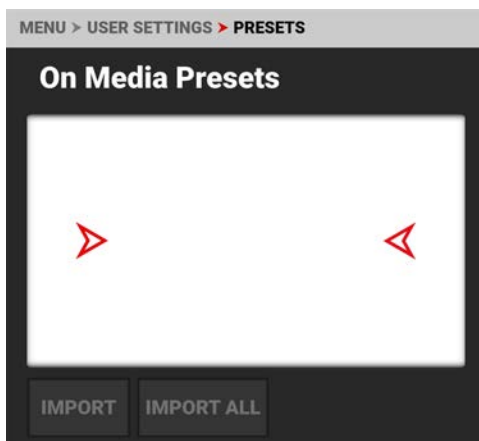

You can import presets from the media to the camera. When importing presets from the media to the camera, the presets are saved to a folder on the camera called “presets”.

From On Media Presets, you can import the selected preset from the media to the camera or import all of the presets from the media to the camera.

IN CAMERA PRESETS



You can export presets from the camera to the media. When exporting presets from the camera to the media, the presets are saved to a folder on the media called “presets”.

From In Camera Presets, you can apply the selected preset to the camera, delete the selected preset from the camera, export the selected preset from the camera to the media, or export all of the presets from the camera to the media.

USER BUTTONS

Use User Buttons to assign functions to the front and side user buttons.

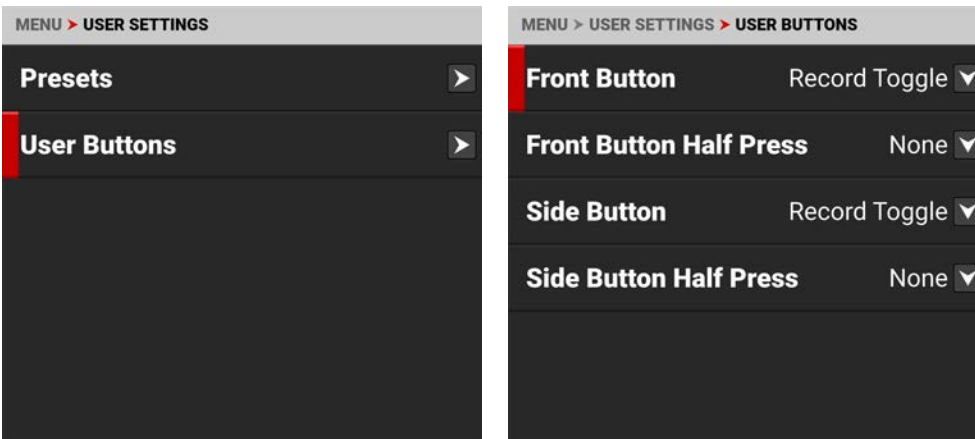

The User Buttons menu contains the following:

ITEMS	DETAILS
Front Button	Assign functions to the front user button
Front Button Half Press	Assign functions to the front button half press
Side Button	Assign functions to the side user button
Front Button Half Press	Assign functions to the side user button half press

FRONT BUTTON

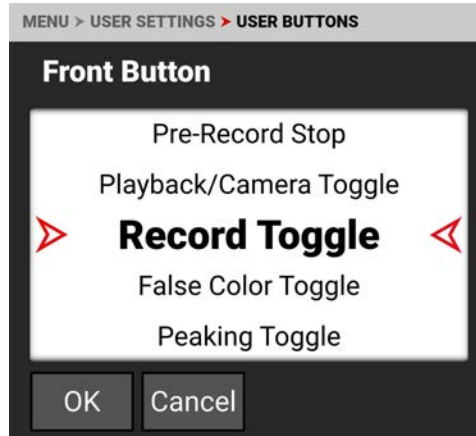
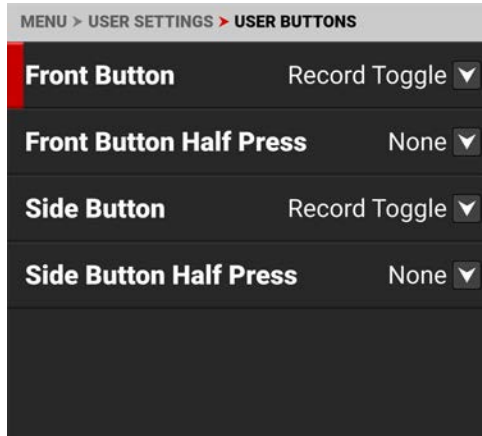

Use Front Button to select the function you want assigned to the front camera button.

The default setting is Record Toggle.

Refer to [User Button Assignable Functions](#) for the options.

FRONT BUTTON HALF PRESS

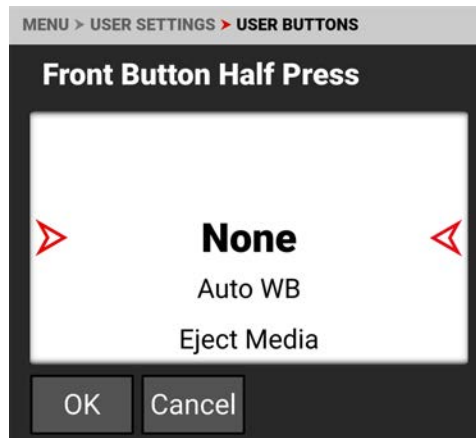
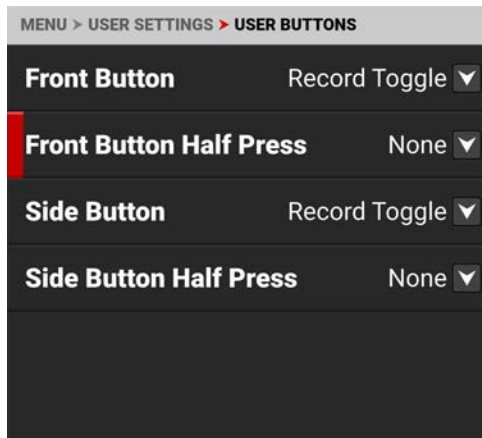

Use Front Button Half Press to select the function you want assigned to the front camera button for a half press.

The default setting is None.

Refer to [User Button Assignable Functions](#) for the options.

SIDE BUTTON

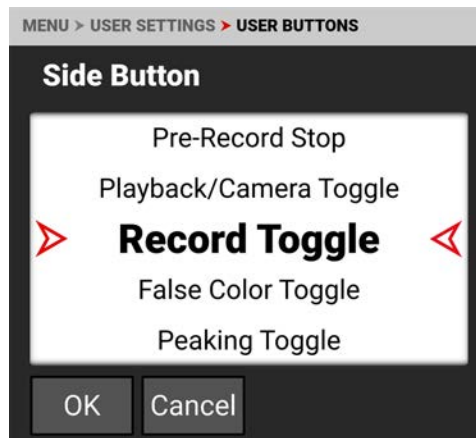
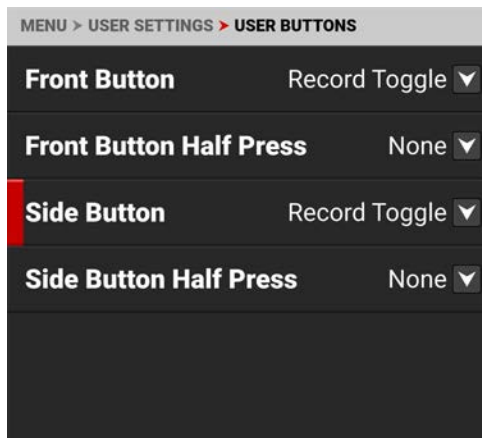

Use Side Button to select the function you want assigned to the side camera button.

The default setting is Record Toggle.

Refer to [User Button Assignable Functions](#) for the options.

SIDE BUTTON HALF PRESS

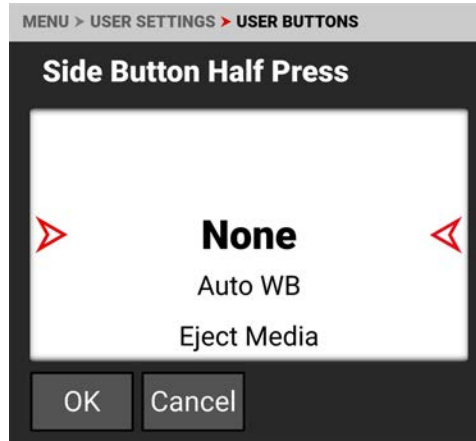
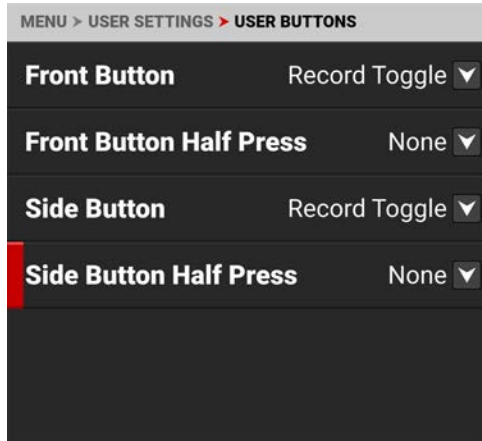

Use Side Button Half Press to select the function you want assigned to the side camera button for a half press.

The default setting is None.

Refer to [User Button Assignable Functions](#) for the options.

USER BUTTON ASSIGNABLE FUNCTIONS

ITEM	DETAILS
None	Nothing is assigned to the User Slot
Apply Preset	Apply the presets stored on the camera
Auto WB	Camera automatically adjusts the White Balance
Eject Media	Unmount the media in preparation for removal
Secure Format	Format the media
Eject USB-C Drive	Eject device connected to USB-C port
Jam TC to TOD	Jam Timecode to time of day
AF Toggle	Toggle the selected autofocus mode
AF Hold	Activates autofocus while pressed
Save Log	Save the log file to the media
LCDs Magnify Toggle	Toggle the magnification feature on and off for all LCDs
SDI Magnify Toggle	Toggle the SDI port magnification feature on and off
Pre-Record Toggle	Toggle the Pre-Record feature on and off
Pre-Record Stop	Stop the Pre-Record feature
Playback/Camera Toggle	Toggle between camera output and clip playback
Record Toggle (default)	Toggle record on and off
False Color Toggle	Toggle the False Color tools on and off
Peaking Toggle	Toggle the Peaking tools on and off
Log View Toggle	Toggle Log view on and off
Zebra 1 Toggle	Toggle Zebra 1 on and off
Zebra 2 Toggle	Toggle Zebra 2 on and off
LCD Guides Toggle	Toggle the Guides on and off on the Onboard LCD

ITEM	DETAILS
LCD Tools Toggle	Toggle the Tools on and off on the Onboard LCD
SDI Guides Toggle	Toggle the Guides on and off on SDI output
SDI Tools Toggle	Toggle the Tools on and off on the SDI output
SDI Overlay Toggle	Toggle between the simple and advanced Overlay on the SDI output
Top LCD Guides Toggle	Toggle the Guides on and off on the DSMC3™ RED® Touch 7.0" LCD
Top LCD Tools Toggle	Toggle the Tools on and off on the DSMC3™ RED® Touch 7.0" LCD
Frame Guide 1 Toggle	Toggle Frame Guide 1 on and off
Frame Guide 2 Toggle	Toggle Frame Guide 2 on and off
Frame Guide 3 Toggle	Toggle Frame Guide 3 on and off
Center Guide Toggle	Toggle the Center Guide on and off
Iris Open	Open the iris
Iris Close	Close the iris
ND Increment	Increase the ND setting by one increment
ND Decrement	Decrease the ND setting by one increment
Shutter Decrement	Decrease the shutter setting by one increment
Shutter Increment	Increase the shutter setting by one increment
Sync Shift Increment (1)	Increase the sync shift setting by one increment
Sync Shift Decrement (1)	Decrease the sync shift setting by one increment
Sync Shift Increment (100)	Increase the sync shift setting by 100 increments
Sync Shift Decrement (100)	Decrease the sync shift setting by 100 increments
Sync Shift Increment (1000)	Increase the sync shift setting by 1000 increments
Sync Shift Decrement (1000)	Decrease the sync shift setting by 1000 increments

AUTOFOCUS MENU

Use Autofocus to enable and configure the camera's Autofocus feature. The lens must support autofocus for this feature to work.

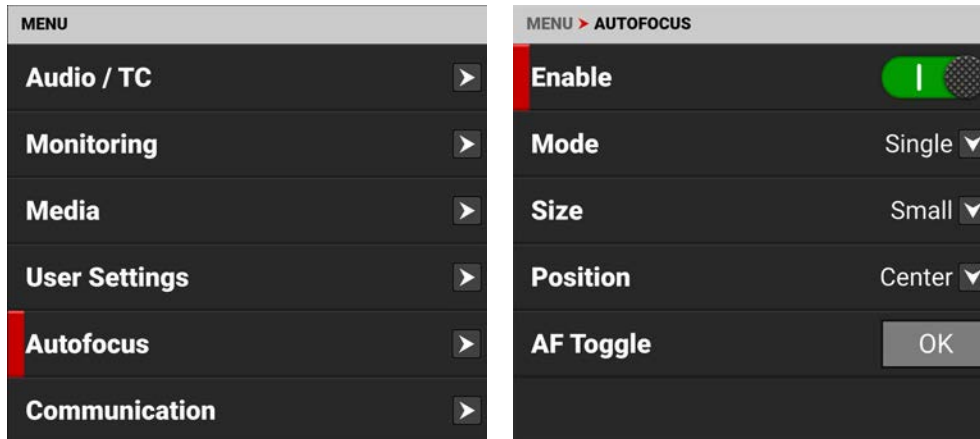

Use the Autofocus menu to perform camera autofocus tasks:

ITEM	DETAILS
Enable	Enable/Disable the Autofocus feature
Mode	Select the Autofocus mode
Size	Select the size of the Autofocus area
Position	Select the position of the Autofocus area
AF Toggle	Toggle the selected Autofocus mode off and on

ENABLE

Use Enable to enable or disable the **Autofocus Menu** feature. The lens must support autofocus for the camera to use this feature.

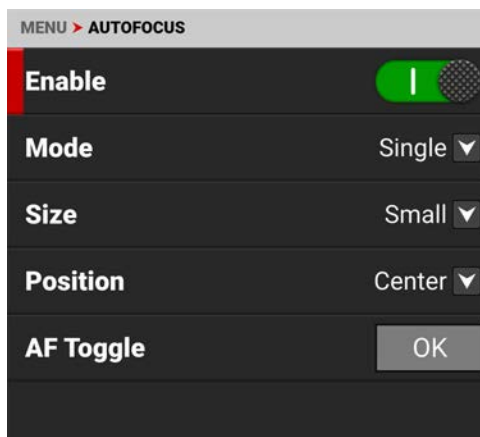

MODE

Use Mode to select the autofocus mode for the camera. The lens must support autofocus for the camera to use this feature.

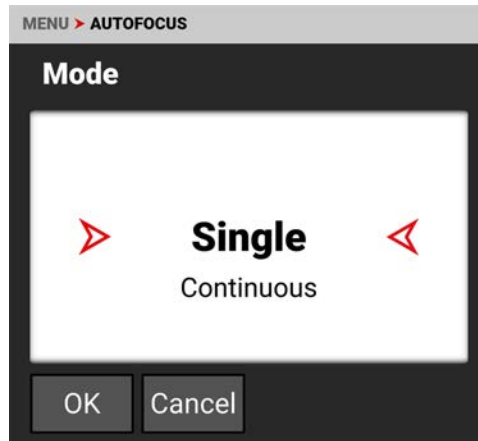
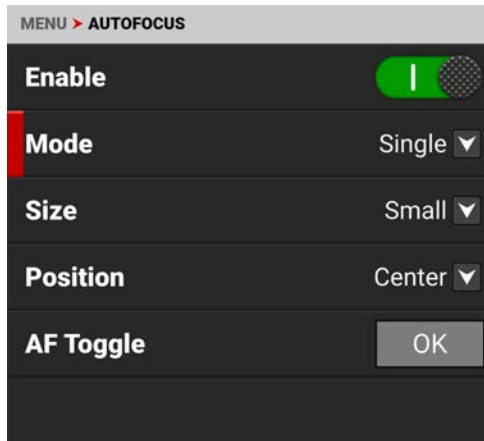

SINGLE MODE (DEFAULT)

Use single mode to autofocus and then stop at that focus position.

CONTINUOUS MODE

Use Continuous mode to continue to change focus to keep a moving subject in focus.

SIZE

Use Size to choose what size area you want the camera to use for the autofocus feature. The lens must support autofocus for the camera to use this feature.

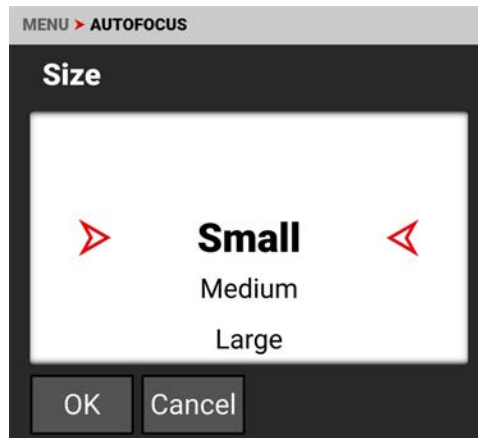
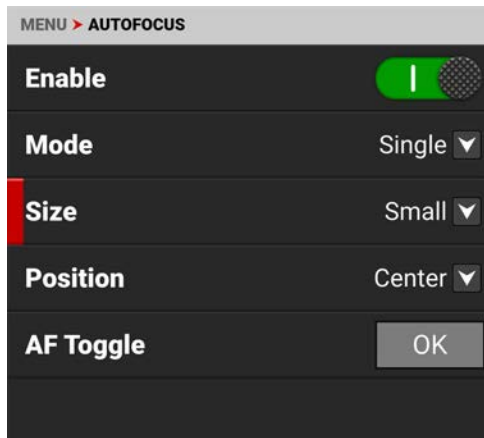

The Size selections for the autofocus area are Small (default), Medium, Large, Wide, and Vertical.

POSITION

Use Position to specify the position of the autofocus area on the sensor. The lens must support autofocus for the camera to use this feature.

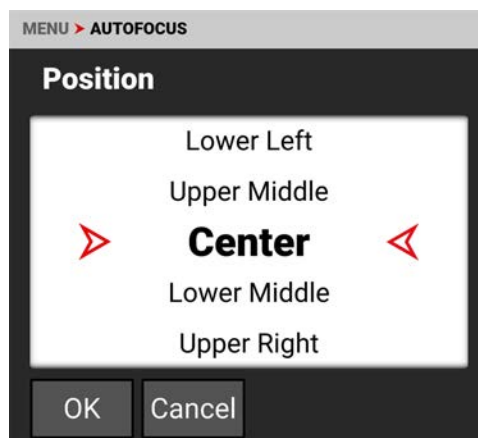
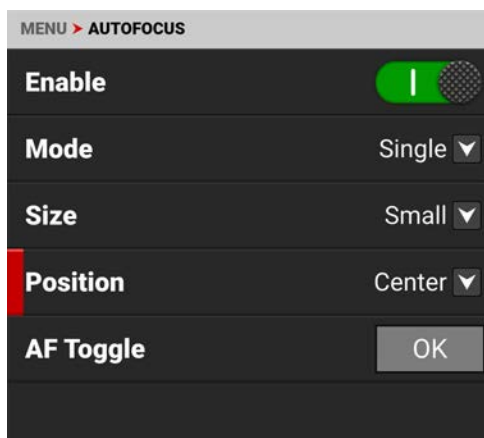

The Position selections include:

- Left
- Upper Middle
- Upper Right
- Upper Left
- Center (default)
- Lower Right
- Lower Left
- Lower Middle
- Right

The Autofocus Position rectangle displays on the screen:



You can move the position manually on the LCD screen. The menu will change to display Custom.

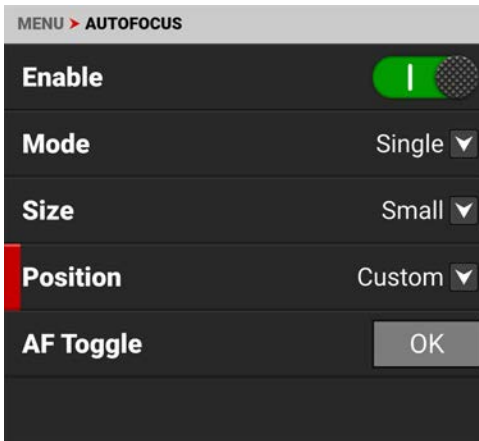

AF TOGGLE

AF Toggle will have different behaviors depending on the Autofocus Mode.

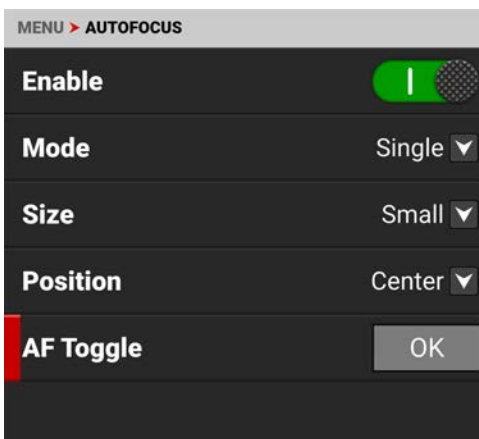

Single Mode: AF Toggle activates a single autofocus command to focus on the subject in the Autofocus box, and then it stops. Each activation of AF Toggle repeats this process.

Continuous Mode: Continuous mode continuously focuses the camera on the subject in the Autofocus box. AF Toggle allows you to stop and start this feature. This control is helpful when you are moving the camera, such as when panning from one subject to another. Tap AF Toggle to disable Continuous autofocus during the pan, to ensure the camera does not attempt to focus during the panning action, and then tap AF Toggle again once the AF Box is over the subject on which you want focus.

COMMUNICATION MENU

The Communication menu contains the settings you use to configure your camera to communicate with other devices. From the camera LCD menu, navigate to, and tap, Communication:

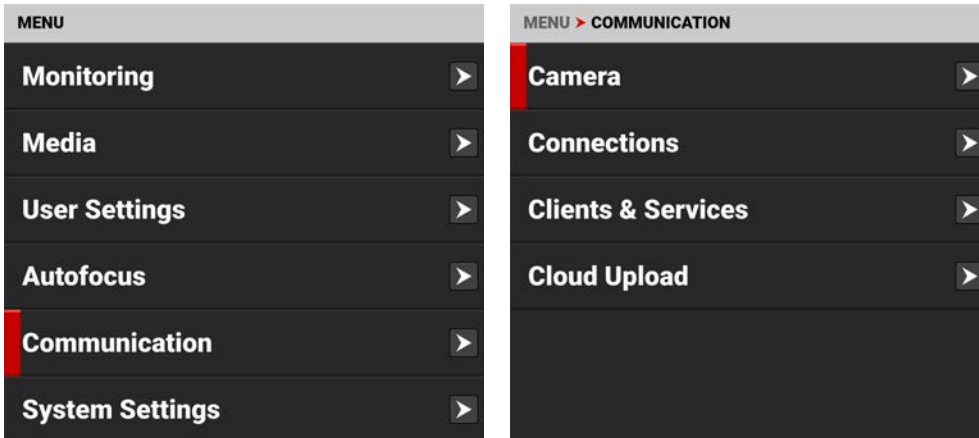

Use the Communication menu to configure the camera's communication settings:

ITEM	DETAILS
Camera	Setting for the camera name
Connections	Settings for USB-C, Wi-Fi, and Serial communication
Clients & Services	Settings for FTPS and PTP communication
Cloud Upload	Settings for Frame.io and AWS S3 communication

CAMERA

Use the Camera menu to view and edit the camera name. Select Camera Name to open the Camera Name editor.

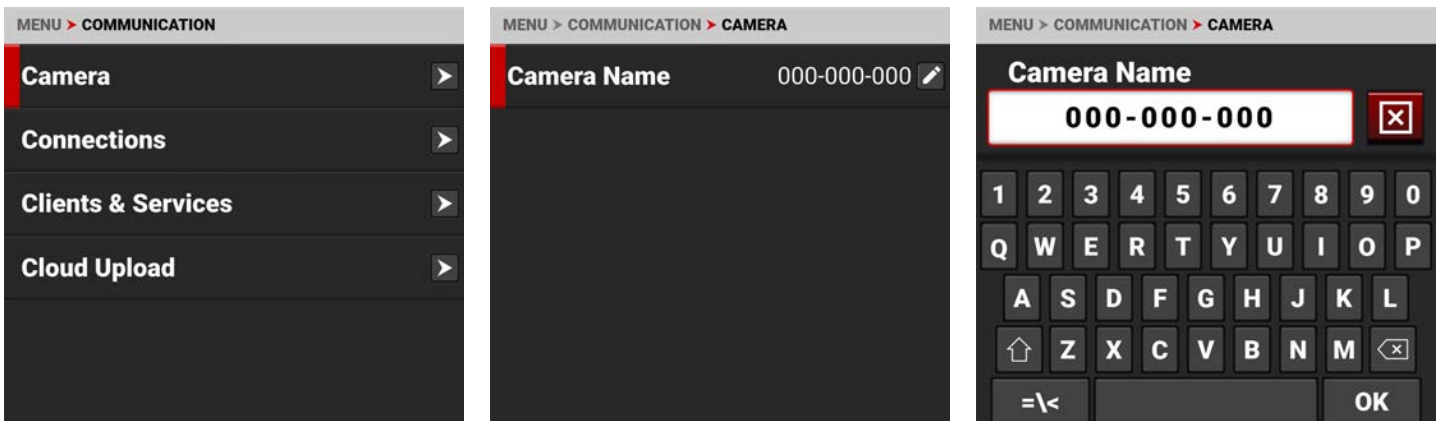

CONNECTIONS

Use the Connections menu to select the connection you want to configure.

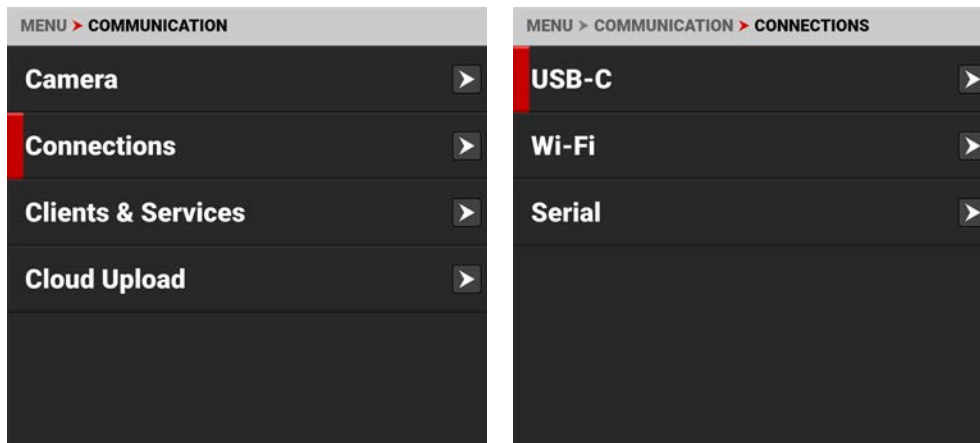

Use the Connections menu to configure the camera's connection settings:

ITEM	DETAILS
USB-C	Select the camera USB-C connection settings
Wi-Fi	Configure the camera Wi-Fi connection settings
Serial	Configure the camera serial connection settings

USB-C

Use USB-C to configure the connection to the USB-C port.

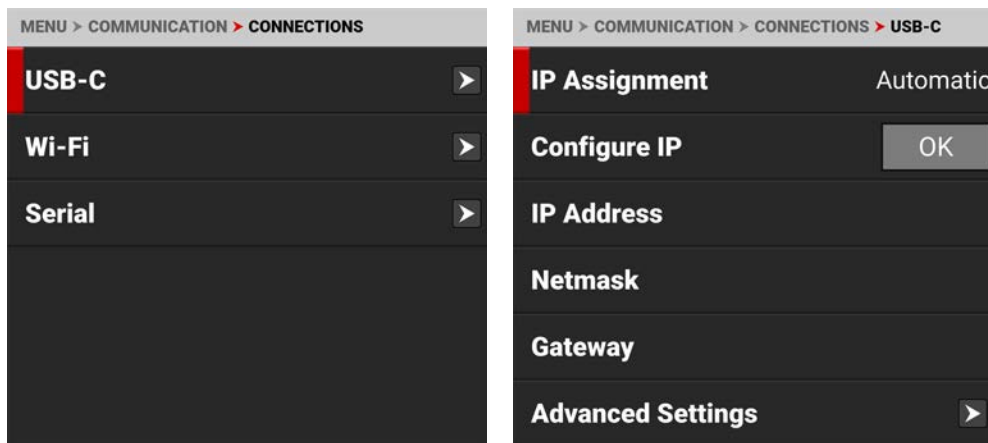

The settings you can configure for the USB-C port include:

ITEM	DETAILS
IP Assignment	Displays the IP address assignment method
Configure IP	IP Address modes and configuration settings
IP Address	View or enter the network IP address
Netmask	View or enter the network Netmask
Gateway	View or enter the network Gateway
Advanced Settings	Change the MTU size

CONFIGURE IP

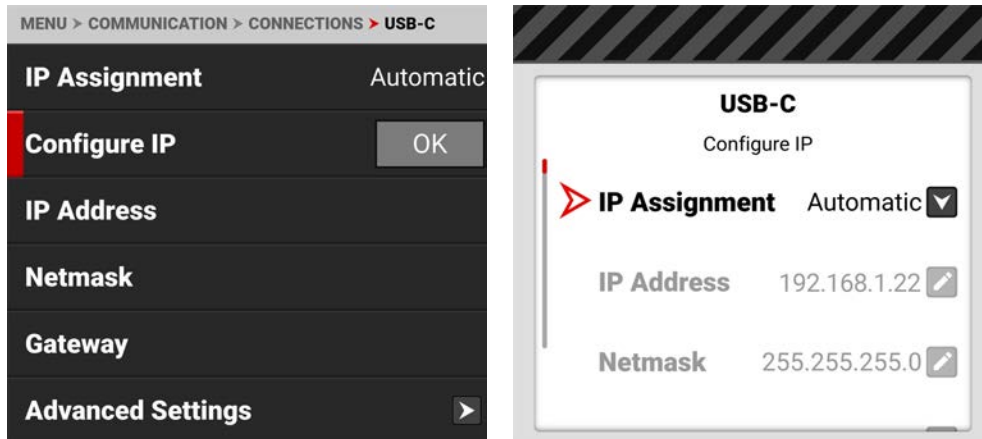

When connected to an Ethernet network, this allows you to automatically detect an IP address or to manually enter an IP address, Netmask address, and Gateway (router) address.

IP ADDRESS

When connected to an Ethernet network and Automatic IP Assignment is enabled, IP Address displays the network IP address.

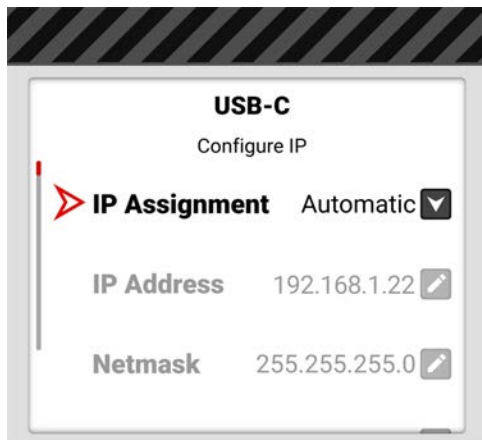

When Manual IP Assignment is enabled, you can select IP Address and manually enter a static IP address.



NETMASK

When connected to an Ethernet network and Automatic IP Assignment is enabled, Netmask displays the network Netmask address.

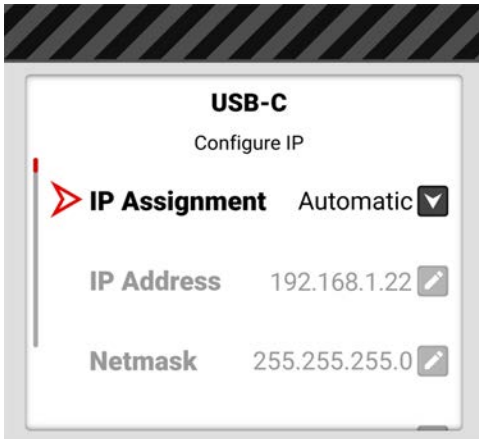

When Manual IP Assignment is enabled, 255.255.255.0 is automatically populated as the Netmask address.



GATEWAY

When connected to an Ethernet network and Automatic IP Assignment is enabled, Gateway displays the network Gateway address (router address).

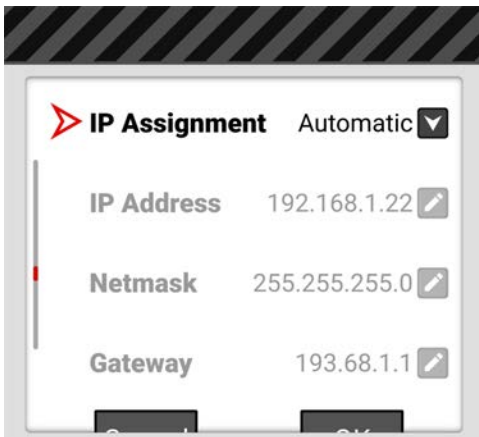

When Manual IP Assignment is enabled, you can select Gateway and manually enter a Gateway (router) address.

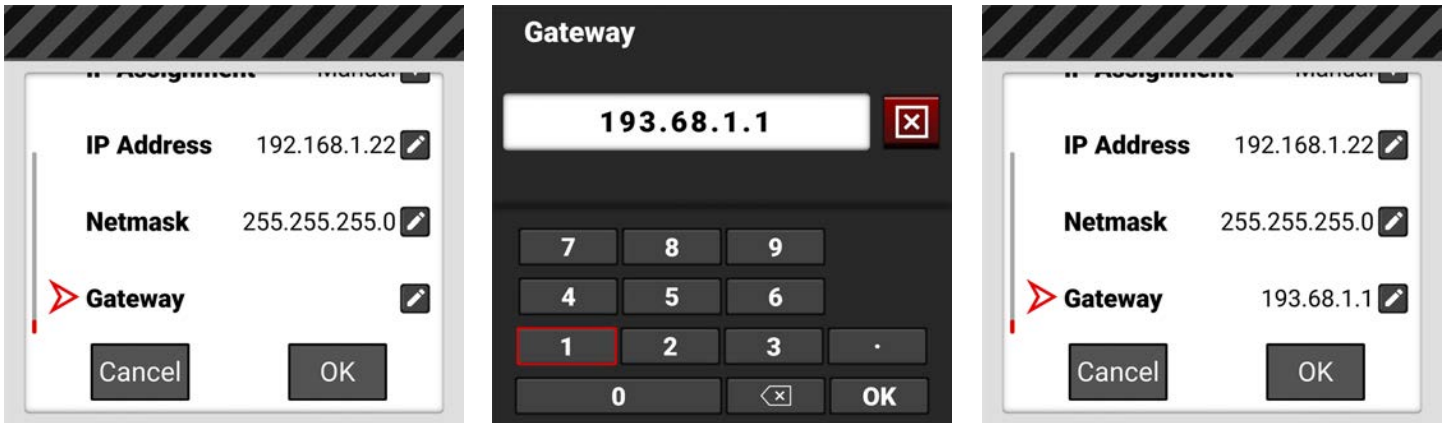

ADVANCED SETTINGS

The USB-C Advanced Settings menu allows you to change the MTU size.

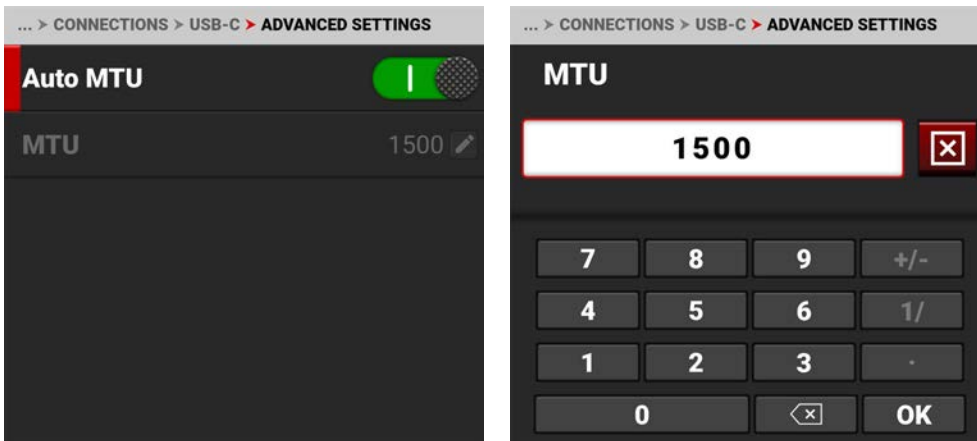

The Auto setting MTU size is 1500 bytes. You can set the MTU to a size larger than the standard 1500 bytes. This works best on fast Ethernet connections like Gigabit LAN. These large MTUs are known as Jumbo frames (as large as 9000 bytes) and they can increase data transmission efficiency and reduce overhead. However, Jumbo frame error correction is slower as a result of re-sending larger packets.

WI-FI

Use Wi-Fi to configure the camera to work with a Wi-Fi connection.

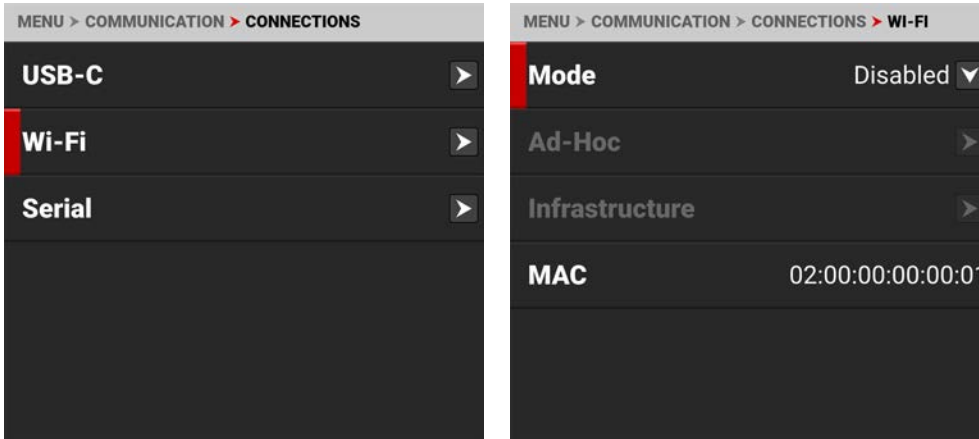

Use the Wi-Fi menu to configure the camera's Wi-Fi settings:

ITEM	DETAILS
Mode	Disable Wi-Fi or select the camera Wi-Fi settings
Ad-Hoc	Configure the camera as a Wi-Fi hot spot
Infrastructure	Settings for connecting to an existing Wi-Fi network
MAC	Displays the camera device MAC address

MODE

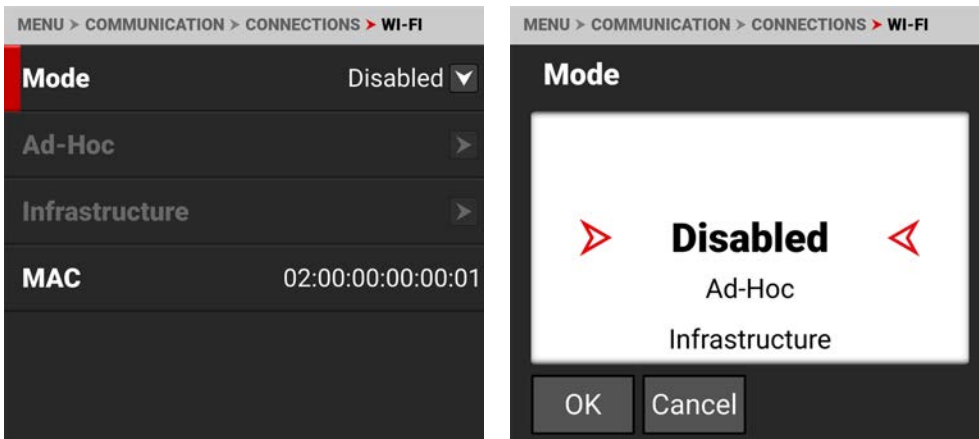

From Mode you can disable the Wi-Fi network, or you can enable the camera's **Ad-Hoc** or **Infrastructure** Wi-Fi settings. The default setting is Disabled.

AD-HOC

Use Ad-Hoc to configure the camera as a Wi-Fi hot spot.

NOTE: The Ad-Hoc menu is enabled when the **Wi-Fi Mode** is set to **Ad-Hoc**.

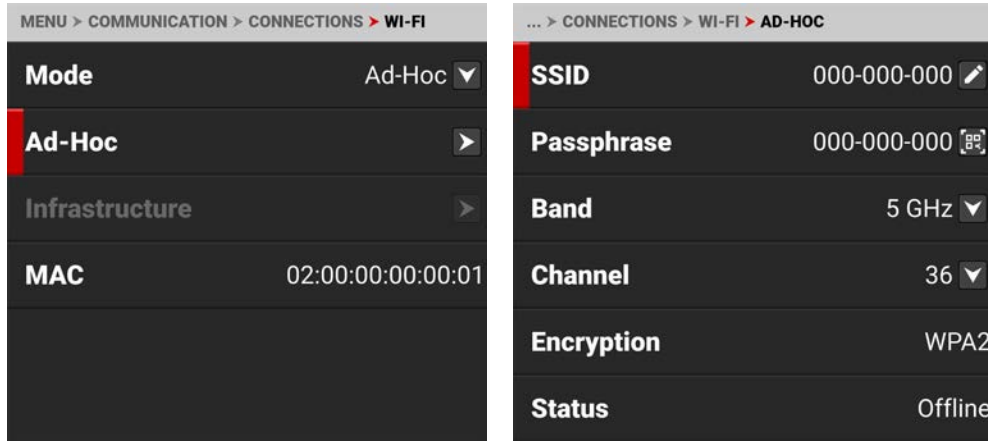

Use the Ad-Hoc menu to configure the Wi-Fi hot spot settings:

ITEM	DETAILS
SSID	Enter the name of the Wi-Fi network the camera generates
Passphrase	Enter the password for the Wi-Fi network
Band	Select the Wi-Fi frequency band
Channel	Select the optimal channel for the Wi-Fi band
Encryption	Displays the encryption type
Status	Displays the connection status
IP Address	Displays the IP address
Netmask	Displays the Netmask

SSID

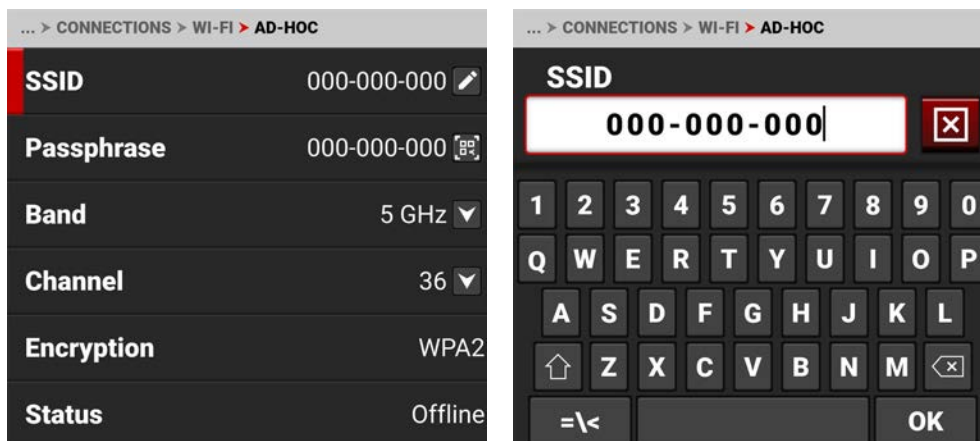

Use the keypad to enter the camera's Wi-Fi network name.

PASSPHRASE

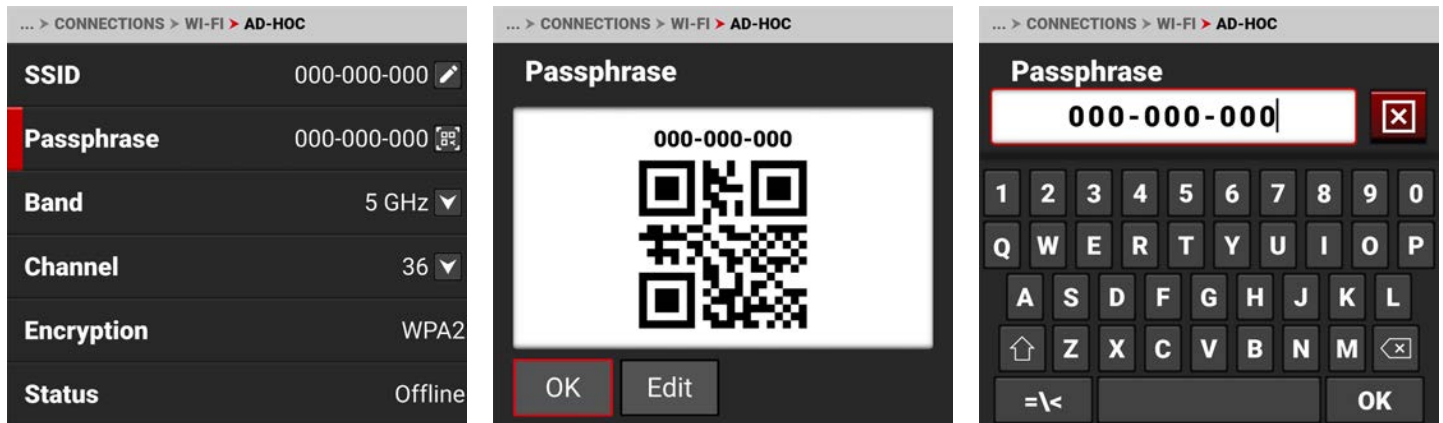

Use the keypad to enter the camera's Wi-Fi passphrase. The camera creates a QR code version of the passphrase.

BAND

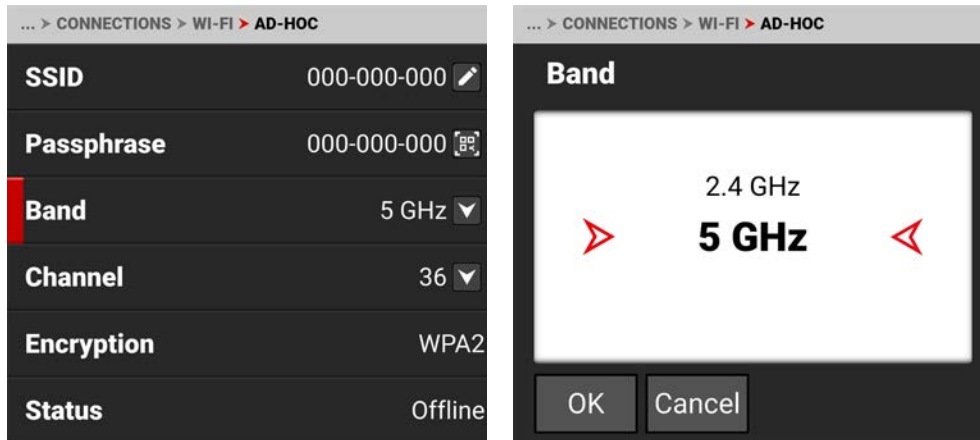

Select the camera's Wi-Fi network frequency band.



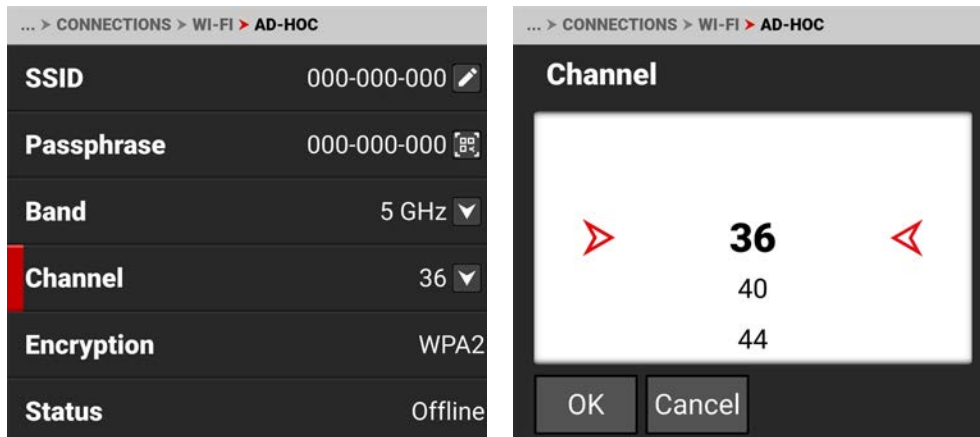

- Use 5 GHz for optimal wireless video streaming performance (default)
- Use 2.4 GHz for extended range remote control (when not utilizing wireless video streaming)

CHANNEL





Select the optimal channel for the selected band, one which receives the least interference from the surrounding Wi-Fi signals.

ENCRYPTION

... > CONNECTIONS > WI-FI > AD-HOC	
SSID	000-000-000 
Passphrase	000-000-000 
Band	5 GHz 
Channel	36 
Encryption	WPA2
Status	Offline

The camera uses WPA2 security encryption.

STATUS

... > CONNECTIONS > WI-FI > AD-HOC	
Passphrase	000-000-000 
Band	5 GHz 
Channel	36 
Encryption	WPA2
Status	Offline
IP Address	

Status displays the camera's Ad-Hoc Wi-Fi connection status.

The Ad-Hoc status includes Offline and Online.

IP ADDRESS

When online and broadcasting a network, the camera displays an IP address.

NETMASK

When online and broadcasting a network, the camera displays the Netmask for the IP address.

INFRASTRUCTURE

Use Infrastructure to configure the camera to connect to an existing Wi-Fi network.

NOTE: The Infrastructure menu is enabled when the Wi-Fi Mode is set to **Infrastructure**. Refer to the [Wi-Fi](#) section for more information.

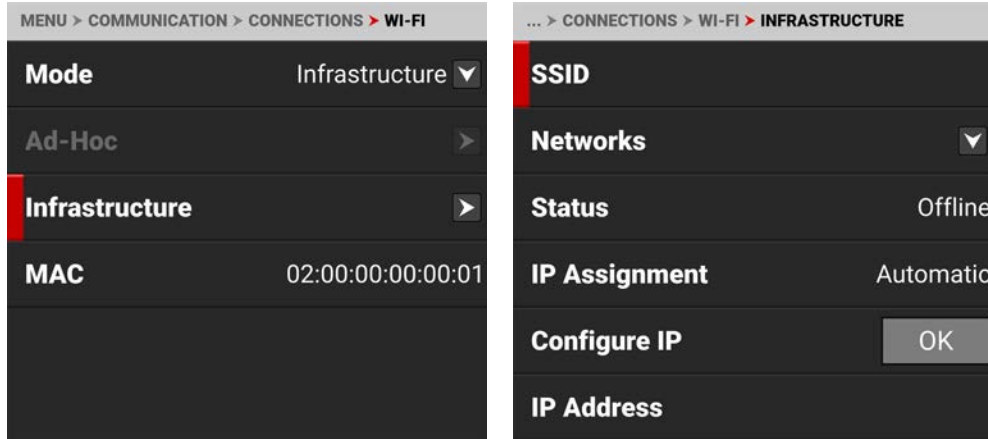

Use the Infrastructure menu to configure the Wi-Fi settings to connect to an existing Wi-Fi infrastructure:

ITEM	DETAILS
SSID	Displays the name of the connected Wi-Fi network
Networks	Scan for, select, or enter the Wi-Fi network
Status	Displays the Wi-Fi connection status
IP Assignment	Displays the IP assignment method
Configure IP	Select the IP Assignment mode and manually enter IP, Netmask, and Gateway addresses
IP Address	View or enter the Wi-Fi network IP address
Netmask	View or enter the Wi-Fi network Netmask
Gateway	View or enter the Wi-Fi network Gateway

SSID

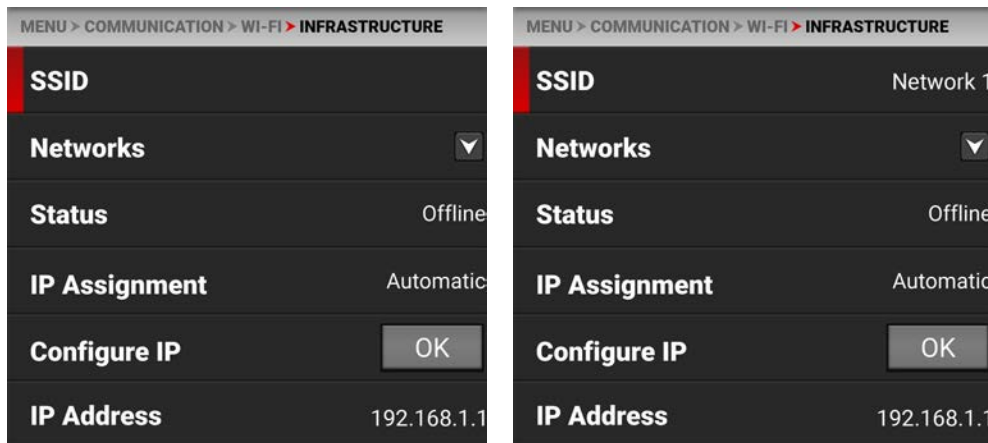

When a network is selected, the SSID displays the Wi-Fi network name (SSID).

NETWORKS

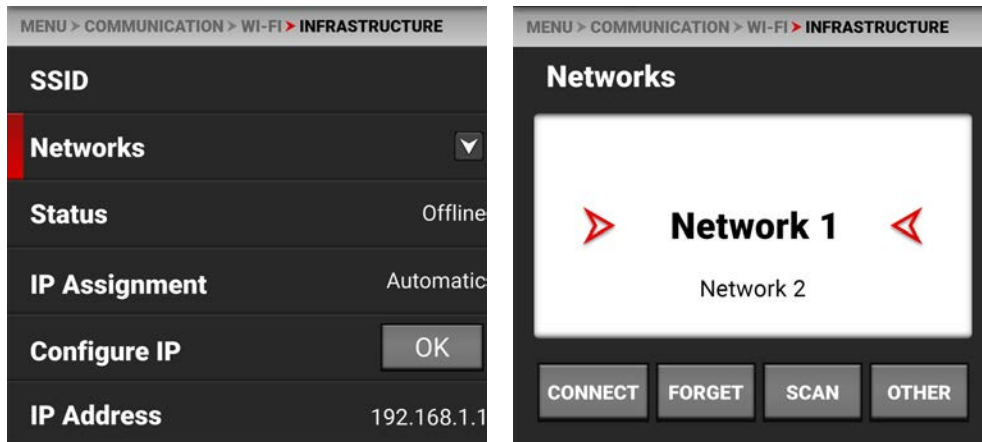

Use Networks to select an existing network, scan for an available network, or to configure a new network.

- **CONNECT:** The CONNECT button connects the camera to the selected network.
- **FORGET:** The FORGET button erases the connection information for the selected network.
- **SCAN:** The SCAN button searches for available networks.
- **OTHER:** The OTHER button opens the OTHER NETWORKS screen where you can manually enter an SSID and a Passphrase.

Tap SSID to open the SSID editing screen and enter the desired network SSID:



Tap Passphrase to open the Passphrase editing screen and enter the desired passphrase for the network:



Tap Connect to connect to the new network:

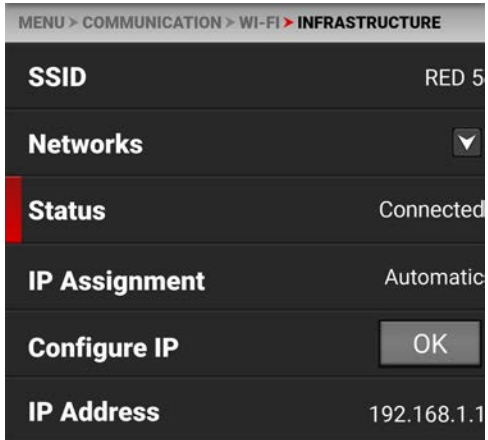

STATUS

Displays the connection status of the camera to the selected Wi-Fi network.

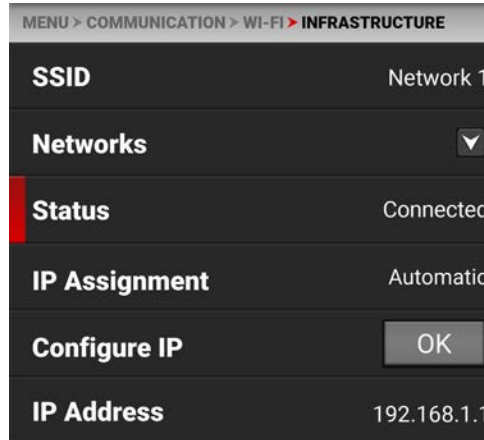
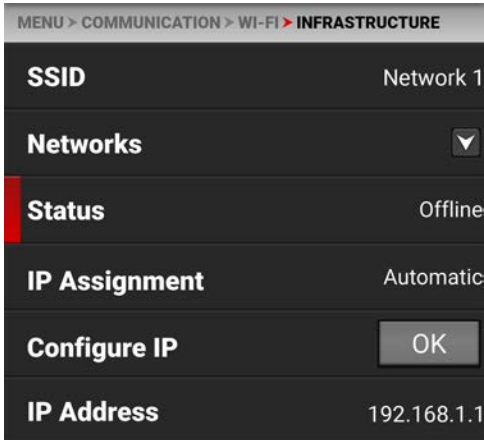

IP ASSIGNMENT

IP Assignment displays the IP assignment mode. In Automatic mode, the camera automatically discovers the Infrastructure IP Address. In Manual mode, you can manually enter the network addresses in the camera.

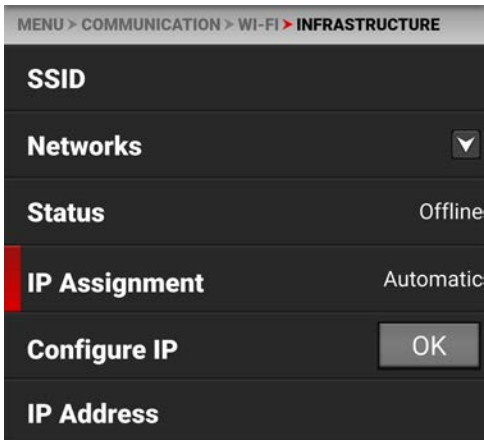

CONFIGURE IP

Tap OK to Open the Infrastructure Configure IP screen.



You use the Configure IP screen to select the IP Assignment mode, and to manually enter the IP, Netmask, and Gateway addresses in Manual mode.

IP ASSIGNMENT SELECTION

IP Assignment allows you to select the Infrastructure IP Assignment mode.

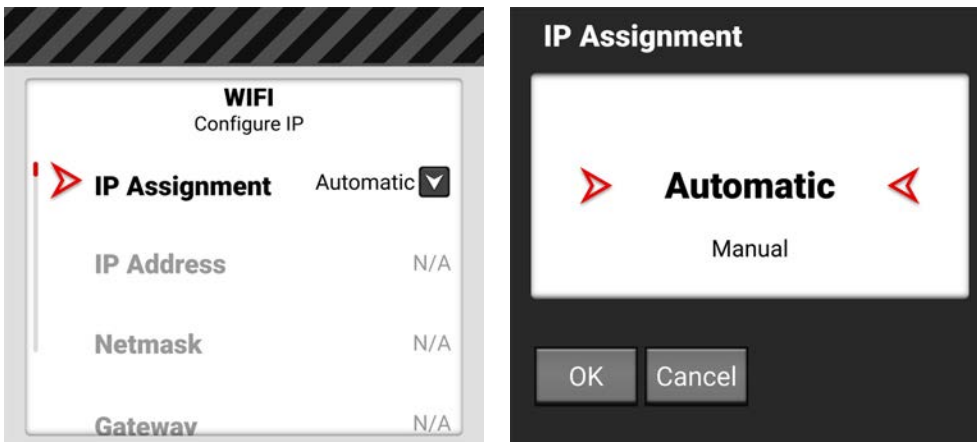

The Automatic mode detects the available Infrastructure IP address. The Manual mode allows you to manually enter the desired Infrastructure network addresses.

IP ADDRESS

When connected to a Wi-Fi network and Automatic IP Assignment is enabled, IP Address displays the Wi-Fi network IP address.



When Manual IP Assignment is enabled, you can manually enter a static IP address.



NETMASK

When connected to an Ethernet network and Automatic IP Assignment is enabled, Netmask displays the network Netmask address.



When Manual IP Assignment is enabled, 255.255.255.0 is automatically populated as the Netmask address.



GATEWAY

When connected to a Wi-Fi network and Automatic IP Assignment is enabled, Gateway displays the Wi-Fi network Gateway address (router address).

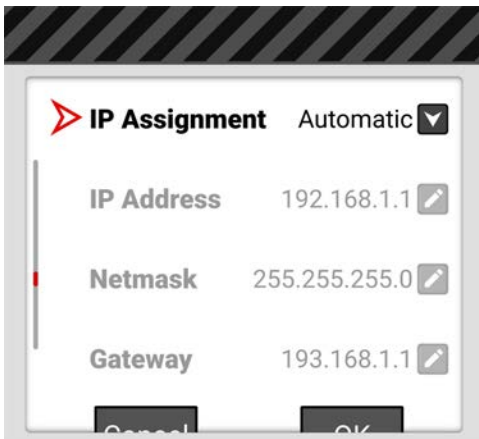

When Manual IP Assignment is enabled, you can manually enter a Gateway address.

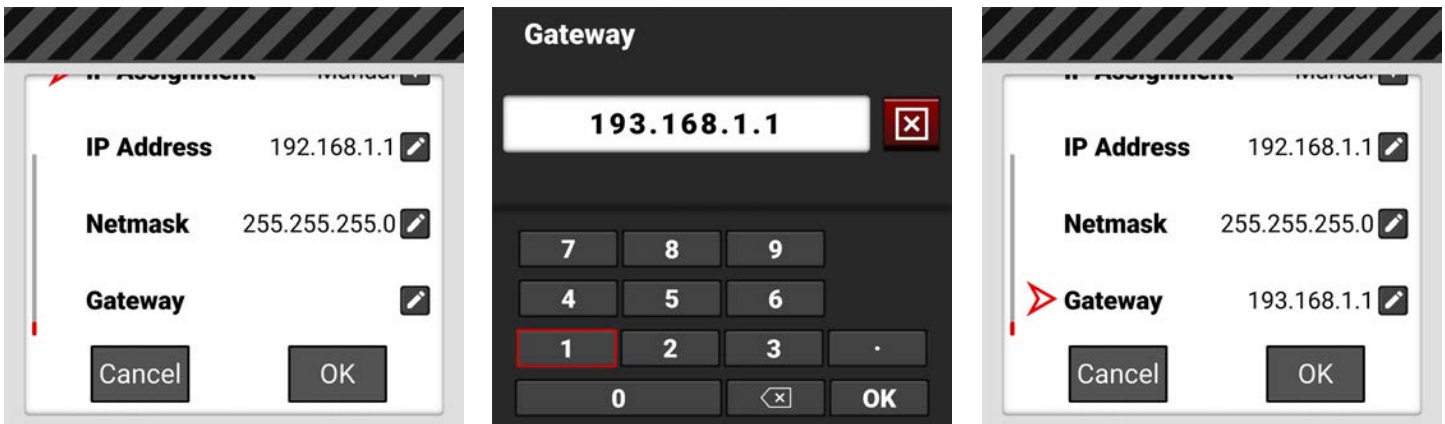

SERIAL

Use Serial to configure the serial connection to the **Extension Port**.

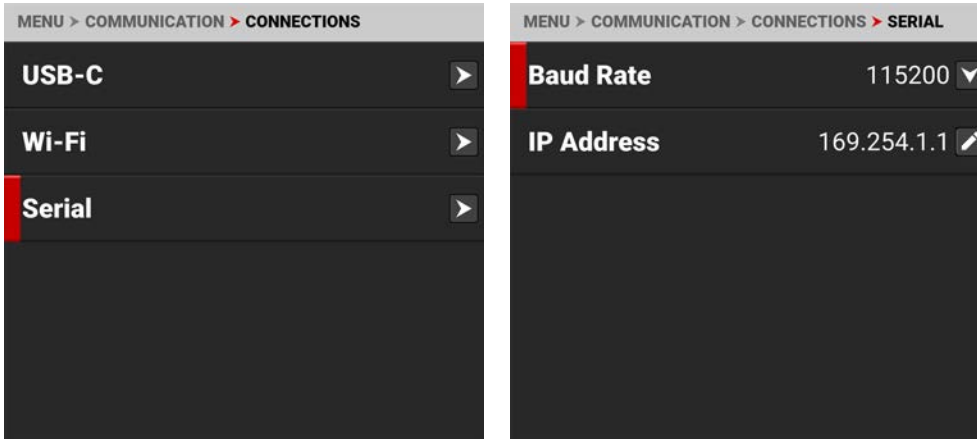

The settings you can configure for the serial connection through the Extension Port include:

ITEMS	DETAILS
Serial	Select the serial port baud rate
Serial	Enter the IP address for the PPP protocol

BAUD RATE

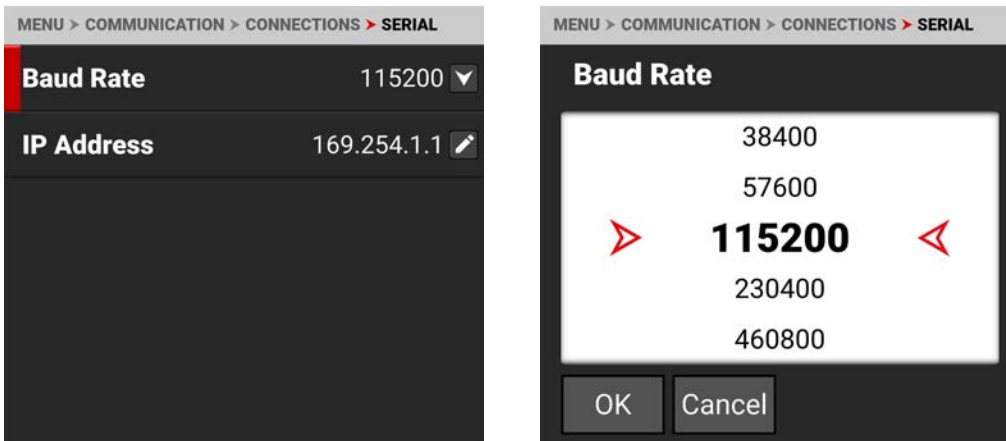

The Baud rate controls how fast data is transmitted over the serial connection. The higher the speed, the more likely that errors can occur. The Baud rates you can choose include:

BAUD RATES			
9600	115200*	576000	1500000
19200	230400	921600	2000000
38400	460800	1000000	2500000
57600	500000	1152000	3000000

* Default

IP ADDRESS

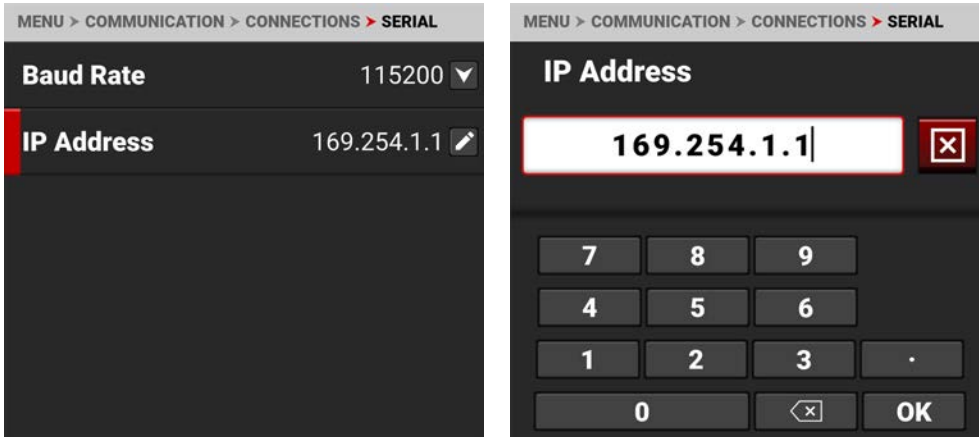

Use the keypad to enter the internet provider's IP address.

CLIENTS & SERVICES

Use the Clients & Services menu to configure the client and service communications for the camera.

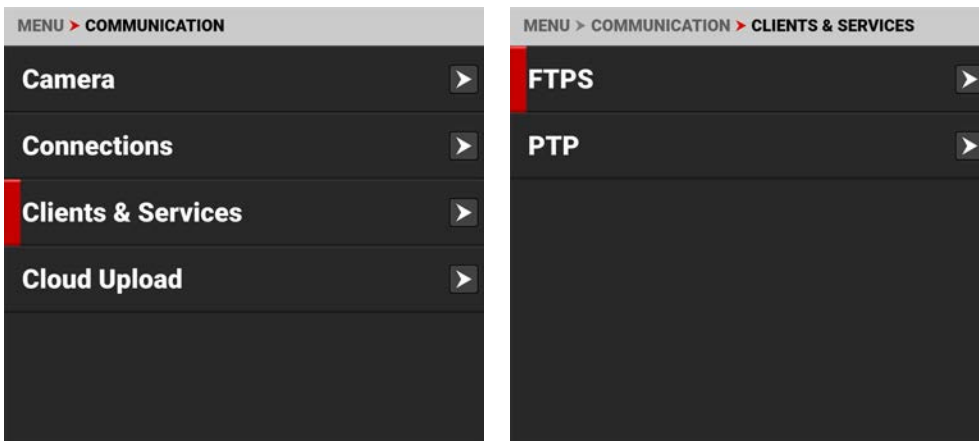

Use the Clients & Services menu to configure the camera's client and service settings:

ITEM	DETAILS
FTPS	Configure the camera FTPS communication settings
PTP	Configure the camera PTP communications settings

FTPS

Use FTPS to configure the camera to work with a secure File Transfer Protocol (FTPS) connection.

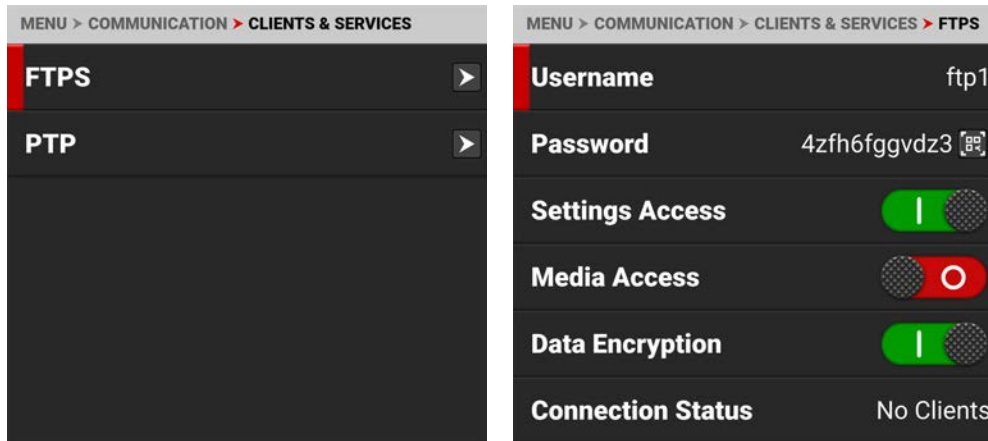

Use the FTPS menu to configure the camera's FTPS settings:

ITEM	DETAILS
Username	Static username ftp1
Password	User-editable password and QR code
Settings Access	Enable FTP access to the camera settings
Media Access	Enable read-only access to the media
Data Encryption	Encrypts the data stream
Connection Status	Displays the FTPS actions occurring

PASSWORD

Use Password to enter an FTPS password. When you select Password, the FTPS Password QR code screen appears.

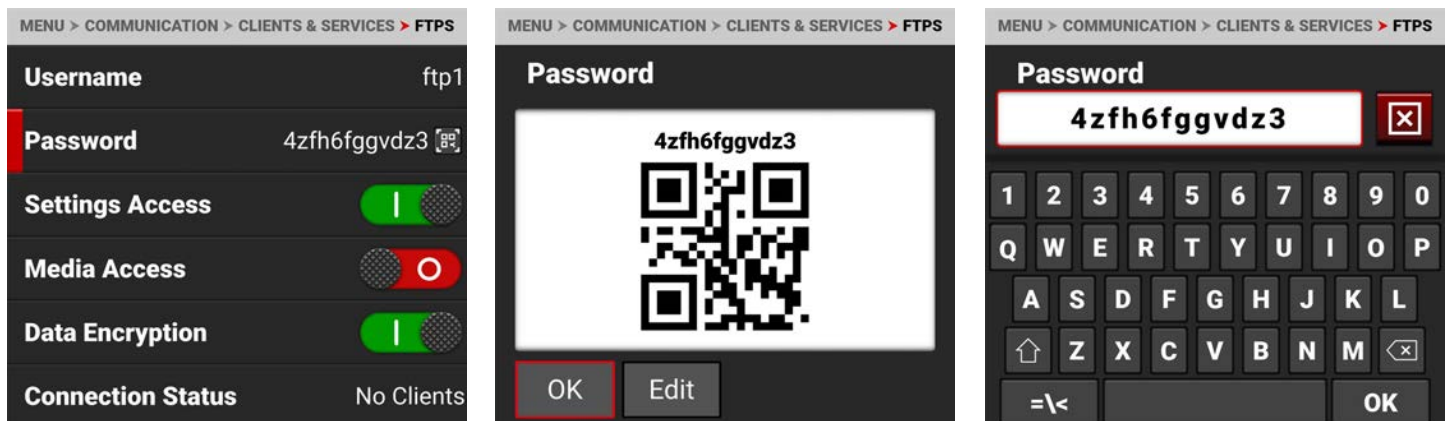

Select EDIT to open the FTPS Password editing screen. The password must contain a minimum of 8 characters. The screen displays passwords shorter than 8 characters in a red font.

PTP

Use PTP to view the precision time protocol status and configure the precision time protocol IP domain.

Enable PTP in **Audio/ TC > Timecode Source** (refer to [Timecode Source](#)).

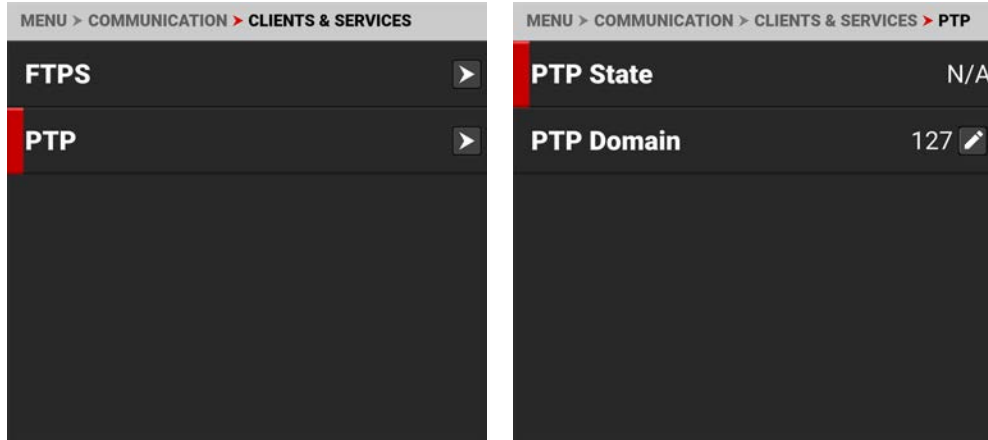

The settings you can configure for PTP include:

ITEM	DETAILS
PTP State	Displays the current status of the precision time protocol
PTP Domain	Allows you to select the precision time protocol domain

PTP DOMAIN

Use PTP Domain to select the precision time protocol domain for the camera. The camera will only receive precision time protocol communications addressed to the selected IP domain.

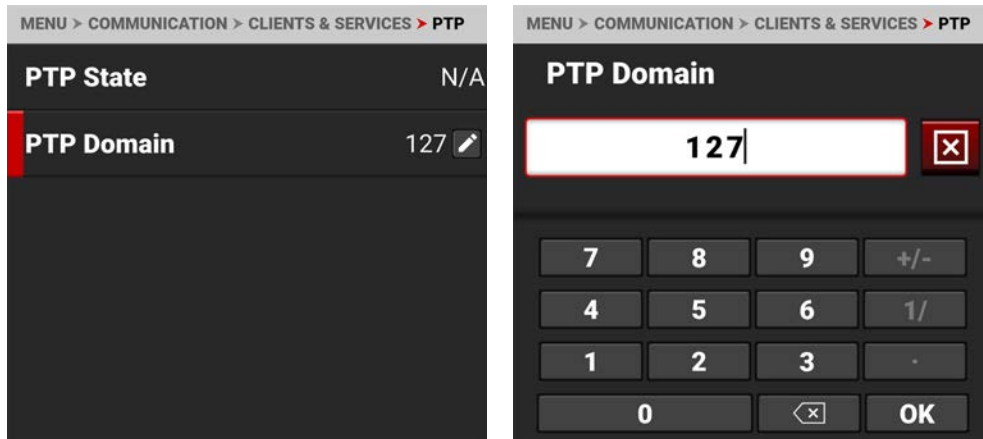

CLOUD UPLOAD

Use the Cloud Upload menu to configure the cloud upload communications for the camera.

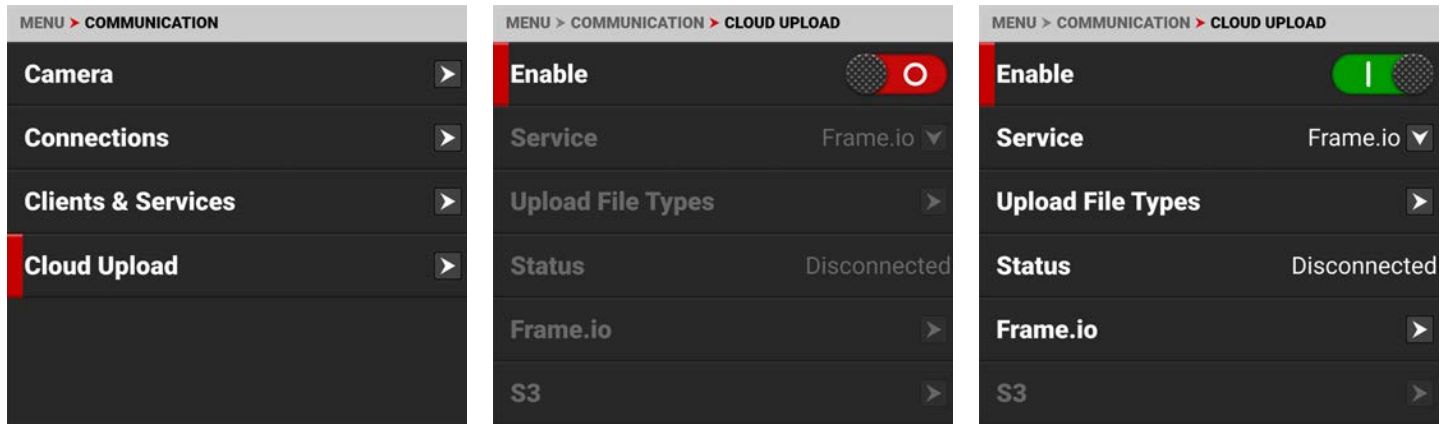

Use the Cloud Upload menu to manage the camera's cloud uploading features:

ITEM	DETAILS
Enable	Enable or disable the Cloud Upload features
Service	Select Frame.io or AWS S3 as the cloud upload service
Upload File Types	Enable or disable the uploading of R3D, MOV, WAV, and CDL/LUT files
Status	Displays the status of the cloud connection
Frame.io	Configure the Frame.io settings when this service is selected
S3	Configure the AWS S3 settings when this service is selected
Clips Remaining	Displays the number of clips remaining to upload
Time Remaining	Displays the time remaining to upload
Upload Remaining	Displays the size of the remaining upload
Upload Speed	Displays the speed of the upload

SERVICE

Use Service to select the type of cloud upload service the camera uses.

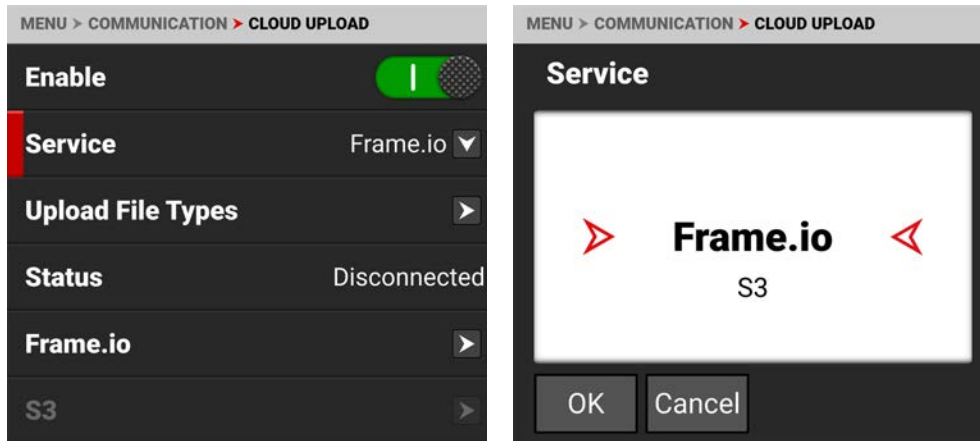

The types of cloud upload services you can select for the camera include:

ITEM	DETAILS
Frame.io	Selects the Frame.io cloud collaboration service
S3	Selects the AWS S3 cloud data management service

UPLOAD FILE TYPES

Use Upload File Types to select the file types you want the camera to upload to the cloud.

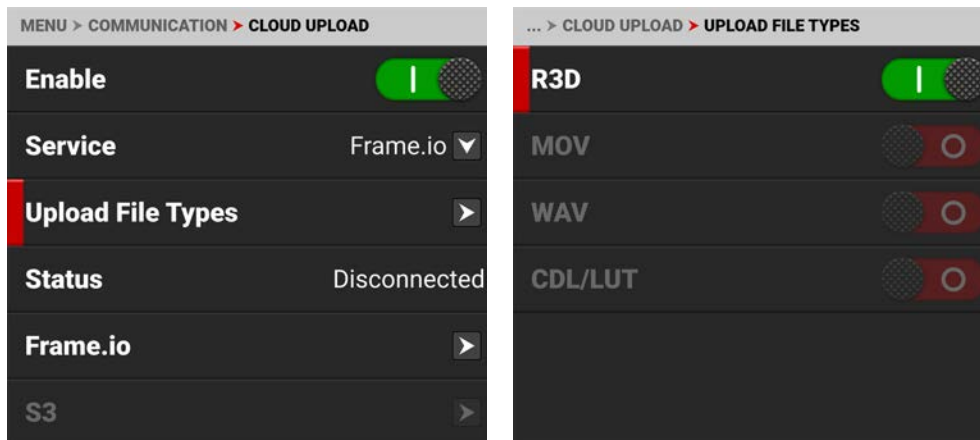

The Upload File Types menu only allows you to enable the file types available on the camera. When they are not on the camera they are grayed-out on the menu.

The Upload File Types you can select include:

ITEM	DETAILS
R3D	REDCODE RAW video file format
MOV	ProRes video file
WAV	Standard Waveform audio data file
CDL/LUT	In camera CDL and LUT files

FRAME.IO

Use Frame.io to connect to, and disconnect from, your Frame.io project.

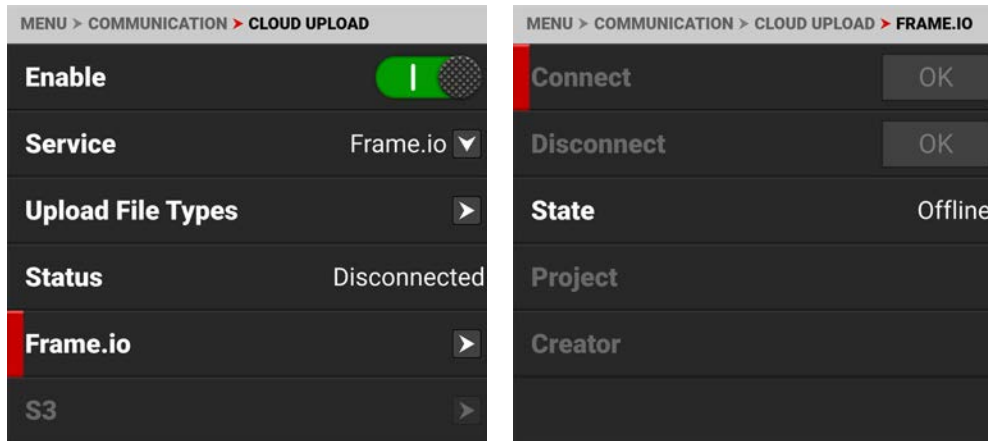

When you select Connect, the screen displays a time sensitive 6-digit code. Use this code to sync the camera to the desired project on the Frame.io website.

S3

Use S3 to configure the camera S3 communications.

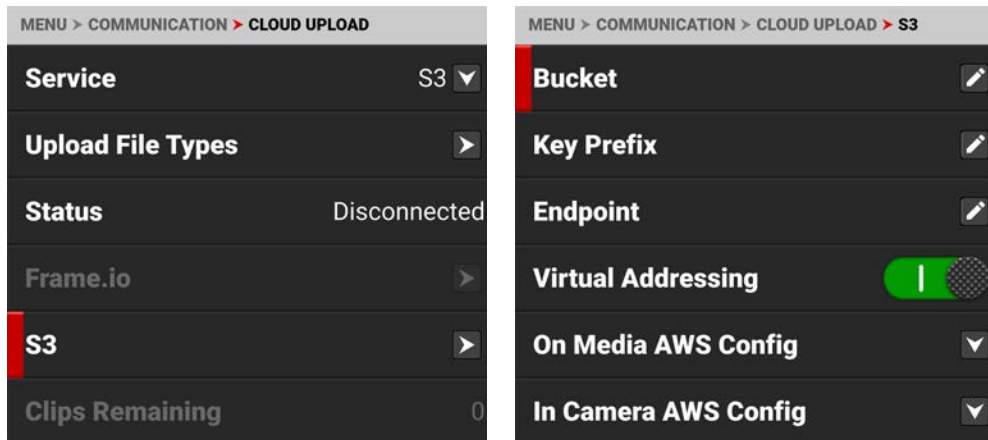

The S3 communications setting you can configure include:

ITEM	DETAILS
Bucket	Enter the S3 Bucket name
Key Prefix	Enter the S3 Key Prefix (optional)
Endpoint	Override the the default S3 Endpoint address (optional)
Virtual Addressing	Enable or disable Virtual Addressing
On Media AWS Config	Select the AWS configuration stored on the media
In Camera AWS Config	Manage the AWS configurations saved to the camera

BUCKET

Use Bucket to enter the name of the S3 Bucket you want to use to upload your data to the cloud.



KEY PREFIX

When specified, the camera adds a prefix to the key (or path) of the uploaded objects to create a subfolder in the bucket (optional).

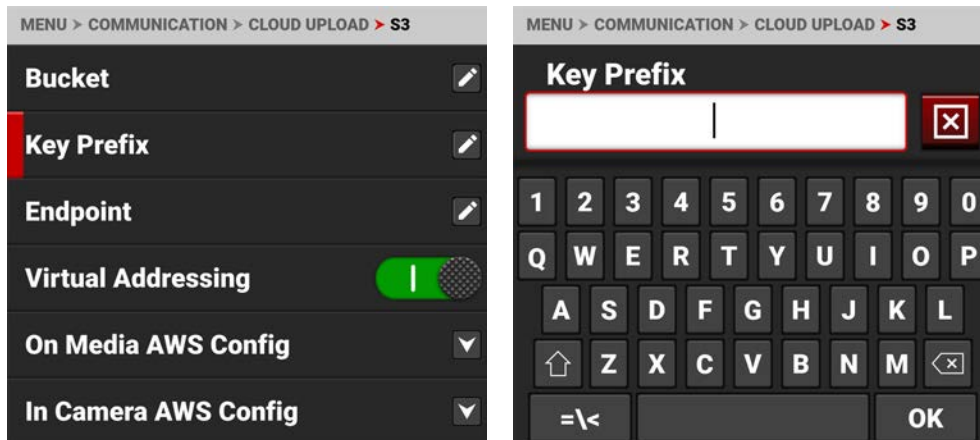

ENDPOINT

Use Endpoint to override the default S3 endpoint address (optional).

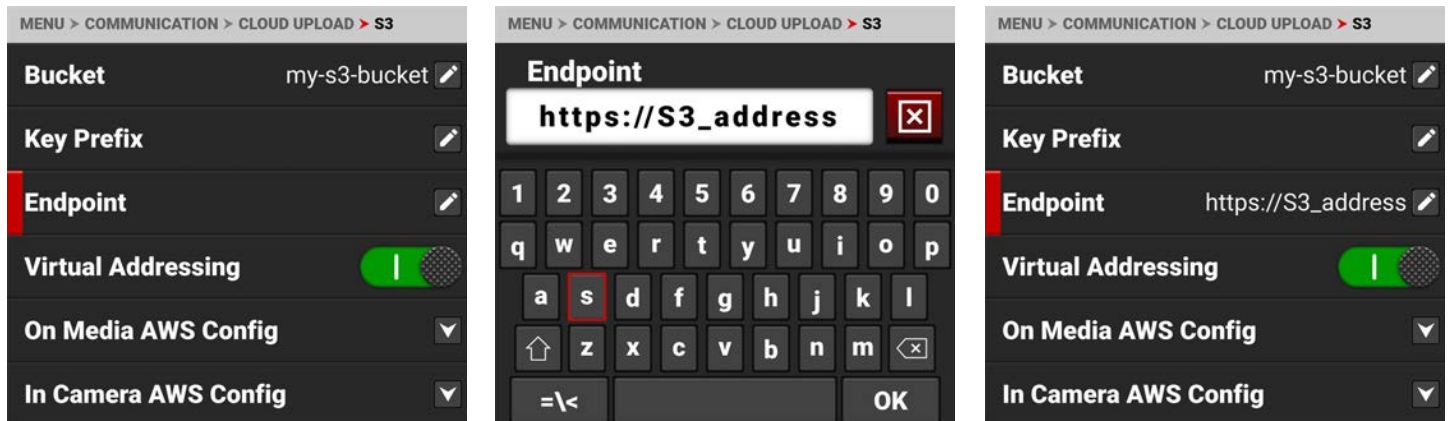

VIRTUAL ADDRESSING

Virtual Addressing is typically enabled. However, you must disable it when interfacing with some S3-compatible storage. Contact your S3 administrator for more information.

ON MEDIA AWS CONFIG

Use On Media AWS Config to select an AWS configuration stored on the media card in the aws folder (/aws).

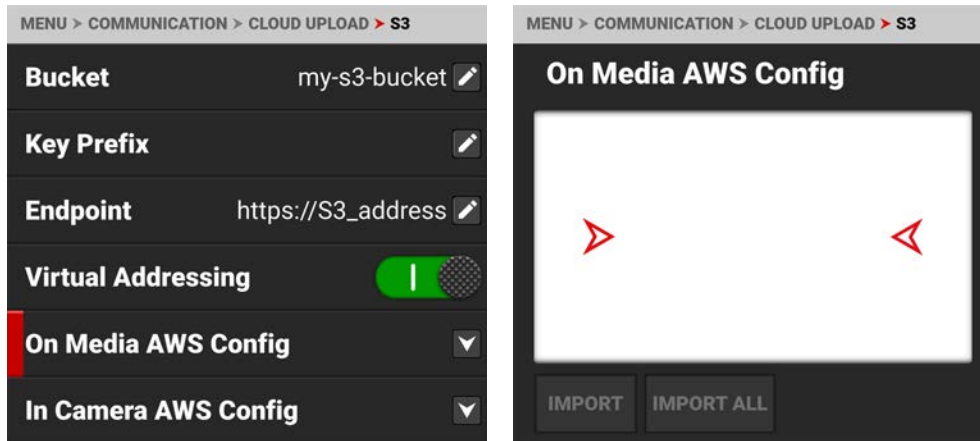

IN CAMERA AWS CONFIG

Use In Camera AWS Config to export or delete AWS configurations stored on the camera.

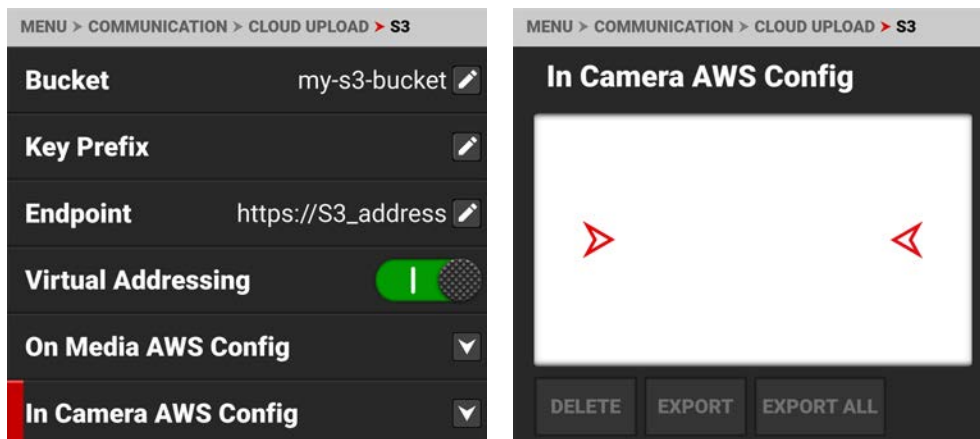

AWS Configuration and Credentials files contain important information for connecting to the AWS bucket, such as region, and access ID / key. AWS CLI tools generate these files when you enter "aws configure". You can also create AWS Configuration and Credentials files manually.

Examples of the AWS configuration and credentials files:

config:

```
[default]
region = us-west-2
```

credentials:

```
[default]
aws_access_key_id = AKIAIOSFODNN7EXAMPLE
aws_secret_access_key = wJalrXUtnFEMI/K7MDENG/bPxrFiCYEXAMPLEKEY
```

SYSTEM SETTINGS MENU

The System Settings menu contains the camera system configuration settings.

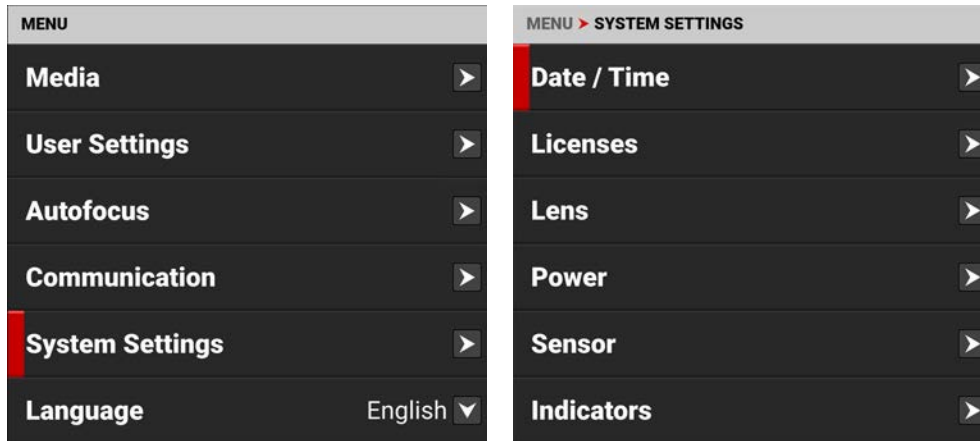

Use the System Settings menu to configure the camera system settings:

ITEMS	DETAILS
Date / Time	Date and time settings
Licenses	Manage camera licenses
Lens	View lens status information and access the lens adjustments
Power	DC and battery status
Sensor	Adjust sensor timing
Indicators	Enable or disable the record sounds and the front Tally LED
GPO Function	Select the General Purpose Out function
Status Settings	Shutter mode, aperture increments, and focus length units settings
System Status	Information about the camera's type, PIN, FW, and runtime

DATE / TIME

Use the Date / Time menu to reset the internal clock of the camera. The time and date are timestamped on R3D[®] files when recording to the media. The camera uses the 24-hour clock convention (military time). For example, enter 2:35 p.m. as 14:35:00.

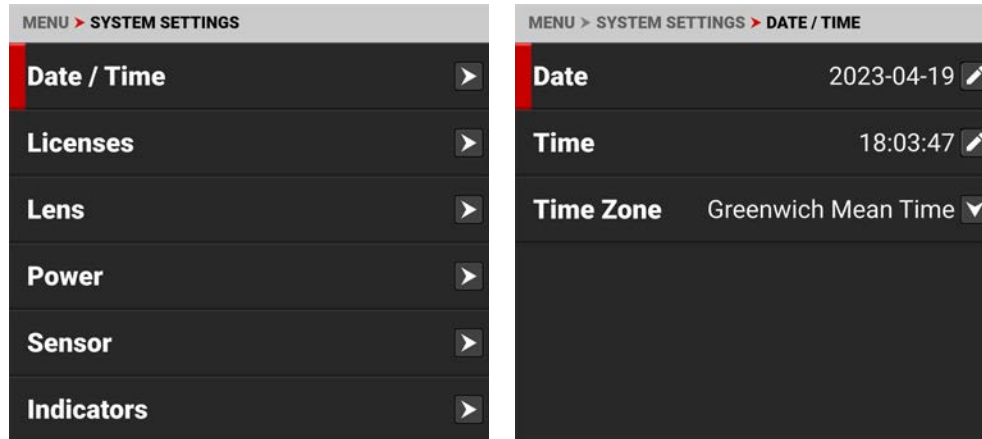

The Date / Time menu items include:

ITEMS	DETAILS
Date	Date in YYYY-MM-DD format
Time	24-hour format
Time Zone	Global time zones

DATE

Use Date to enter the date using the touchscreen keypad:

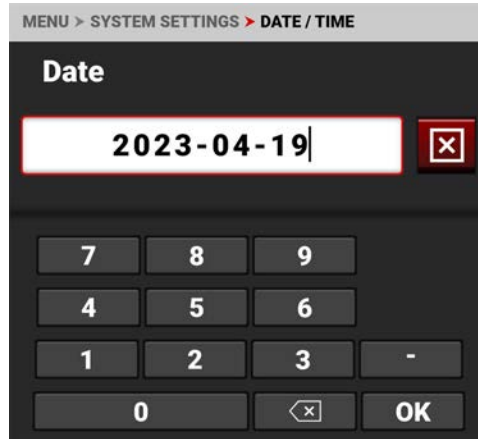
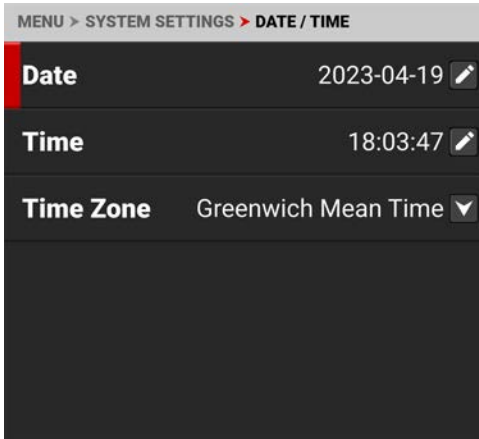

TIME

Use Time to enter the time in 24-hour military format using the touchscreen keypad:

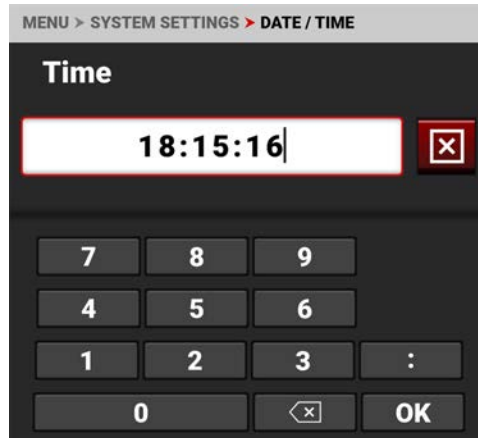
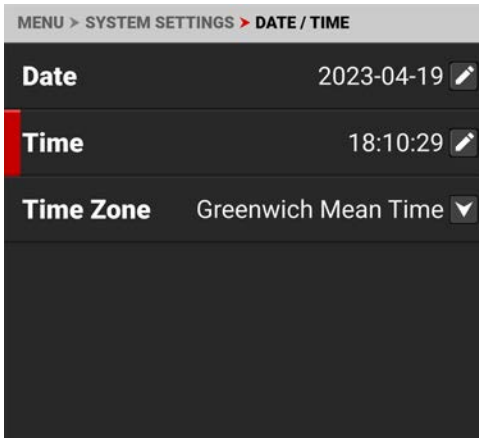

TIME ZONE

Use Time Zone to select the local time zone for where the camera is located.

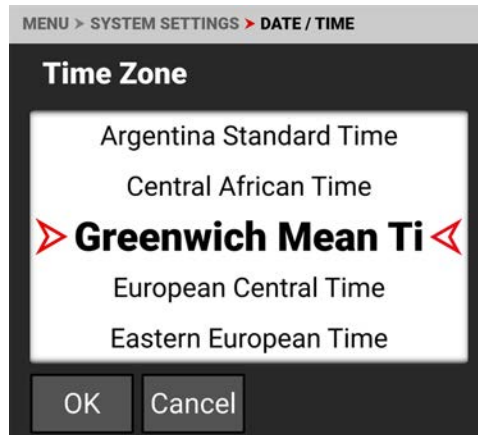
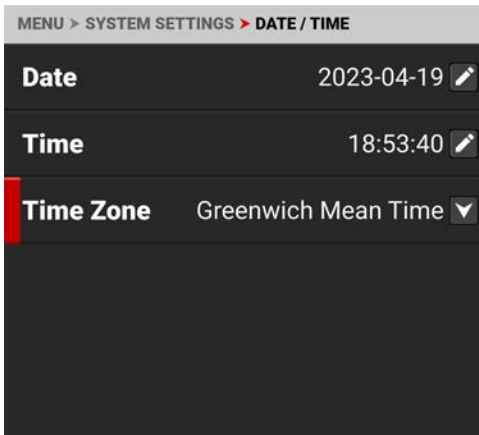

LICENSES

Use the Licenses menu to manage your RED camera licenses.

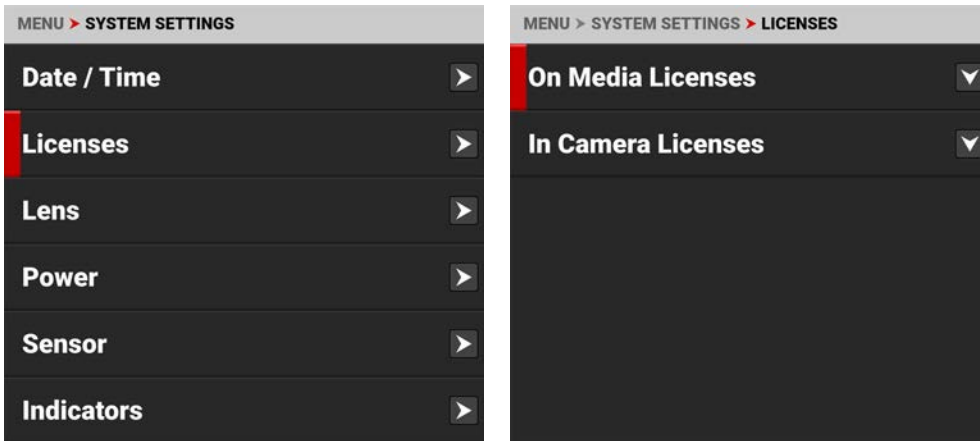

You can manage the licenses stored on the media card, and you can manage the licenses stored in the camera.

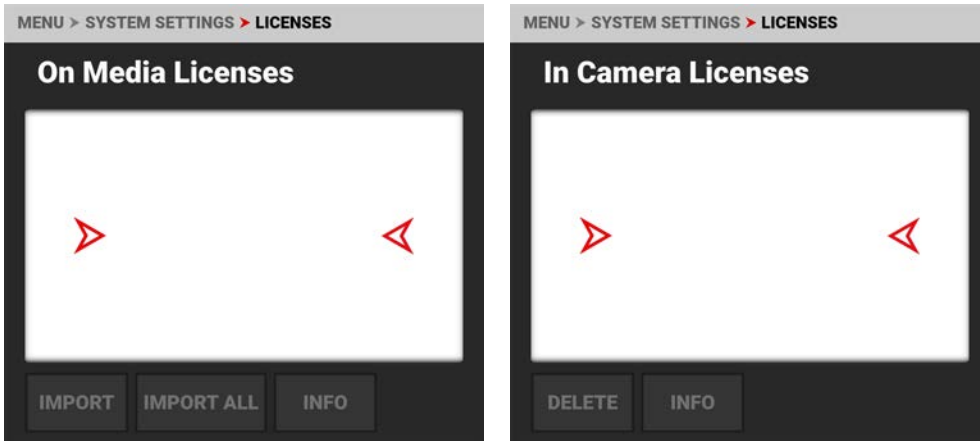

LENS

Use Lens to view information about the attached lens.

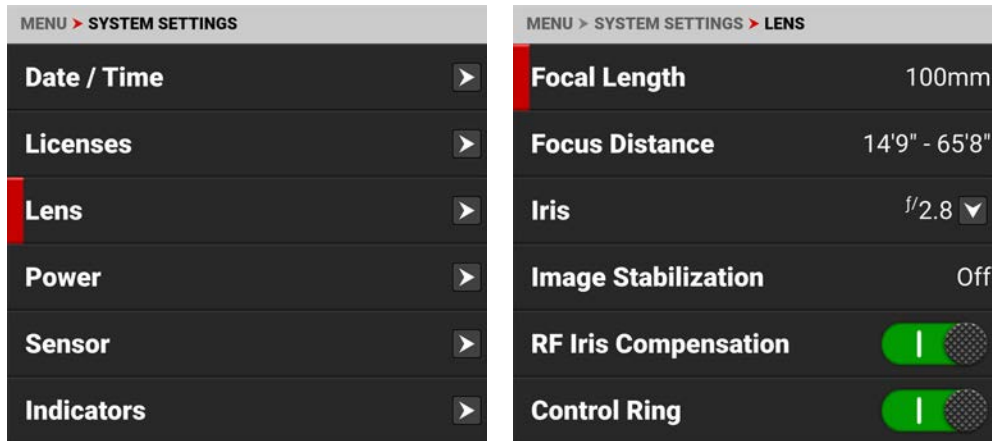

The information you can view from Lens includes:

ITEMS	DETAILS
Focal Length	Displays the lens focal length value
Focus Distance	Displays the lens focal distance value
Iris	Lens Iris menu
Image Stabilization	Displays the lens image stabilization status
RF Iris Compensation	Enables RF Iris Compensation
Control Ring	Enables the lens control ring
Control Ring Mode	Control Ring Mode settings
<i>/i Data</i>	View the PL mount lens <i>/i Data</i> information

IRIS

Use the Iris menu to select the camera lens f-stop. Tap Edit to open the keypad and enter the f-stop manually.

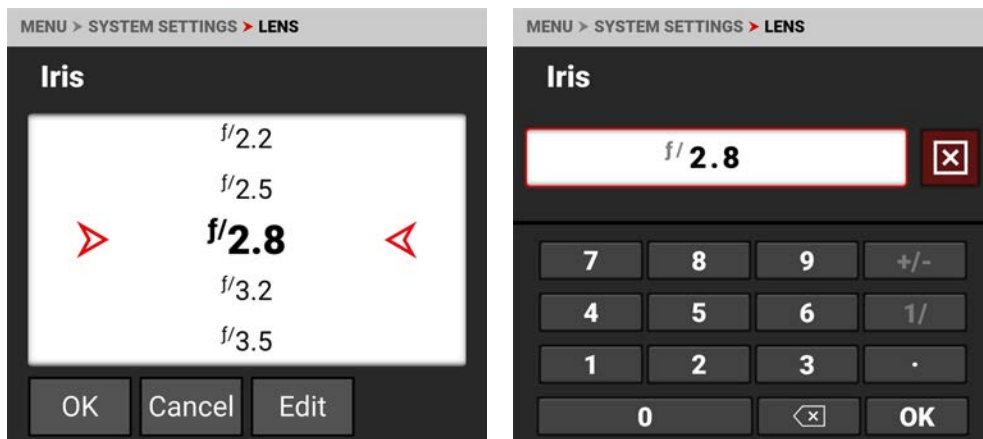

RF IRIS COMPENSATION

Use RF Iris Compensation to compensate for iris position shifting that can occur with certain RF zoom lenses as you change the focal length. This compensation keeps the iris reasonably maintained when the focal length is changed after you set the iris. When enabled, a small iris fluttering may be visible during zooming. You can disable RF Iris Compensation to stop the iris fluttering.

CONTROL RING MODE

Use Control Ring Mode to select the camera setting you want the Control Ring to adjust.

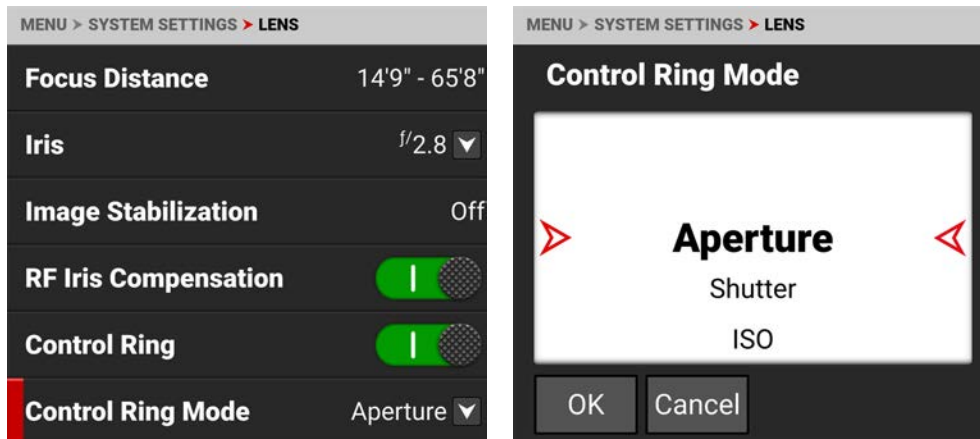

The modes you can select include Aperture (Iris, default), Shutter, ISO, White Balance, LCD Magnify, SDI Magnify, LCDs + SDI Magnify, False Color Cycle, Peaking Cycle, and Tools Cycle.

/i DATA

Use /i Data to view the PL mount lens /i Data information.

NOTE: This menu item is only available when using a /i Data capable PL mount and lens.

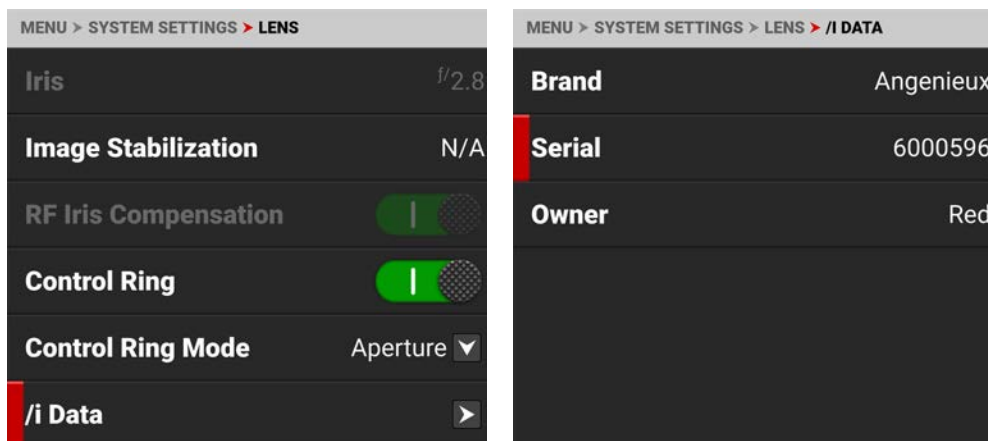

You can view the lens Brand, Serial number, and Owner name.

POWER

Use the Power menu to view the various camera power status indicators:

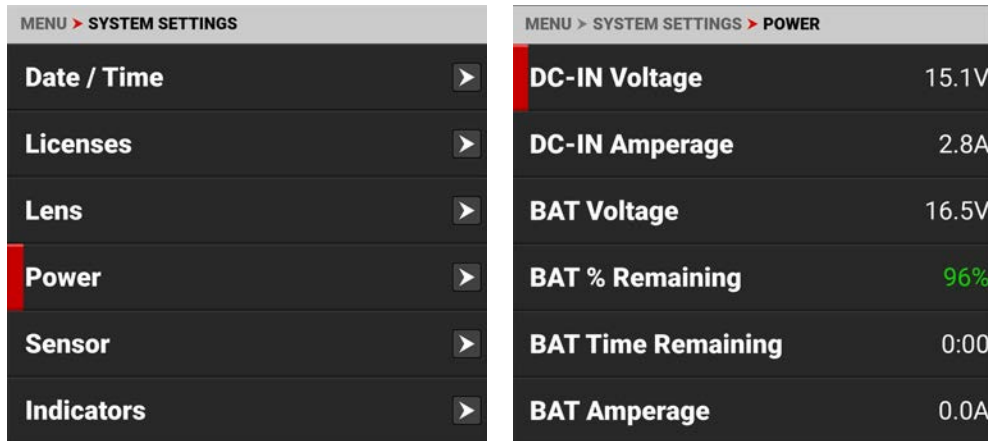

The Power indicators you can view include:

ITEMS	DETAILS
DC-IN Voltage	When DC is connected, this displays the DC Voltage
DC-IN Amperage	When DC is connected, this displays the DC Amps
BAT Voltage	When a battery is connected in the left #1 slot, this displays the battery Voltage
BAT % Remaining	When a compatible battery is connected in the left #1 slot, this displays the % of battery charge remaining
BAT Time Remaining	When a battery is connected in the left #1 slot, this displays the camera operating time remaining
BAT Amperage	When a battery is connected in the left #1 slot, this displays the battery Amps
Low Voltage Warning	Set the DC-IN low voltage warning threshold
Power Out	Enables or disables the 5 V / 500 mA power out of the Extension Port

LOW VOLTAGE WARNING

Use Low Voltage Warning to set the desired voltage level to trigger the low voltage warning. The warning displays on the LCD and across Overlay Modes that contain power status (refer to the **Status Bar** section for more information about the status icons).

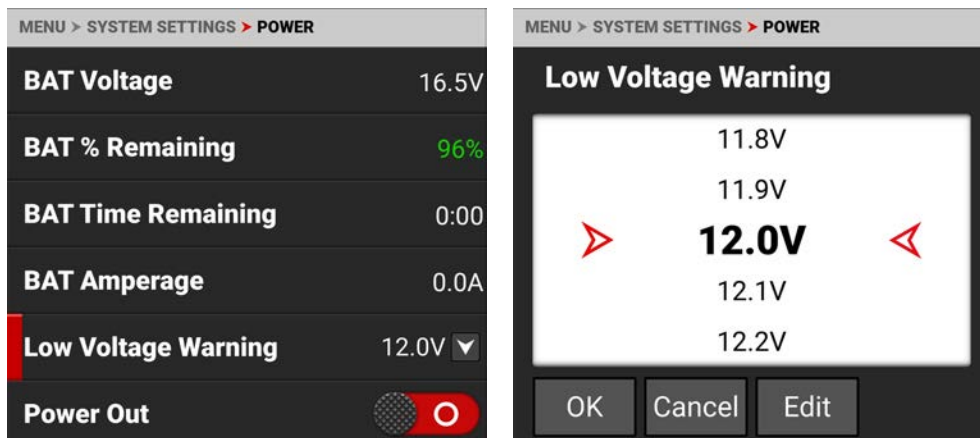

SENSOR

Use Sensor to shift the sync signal.

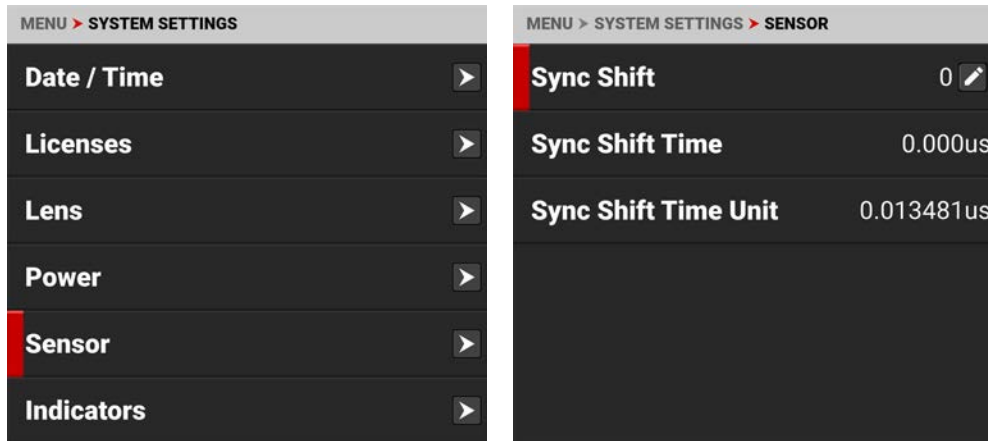

The Sensor menu includes:

ITEM	DETAILS
Sync Shift	Enter the desired amount of sync shift
Sync Shift Time	Displays the Sync Shift time in microseconds (μs)
Sync Shift Time Unit	Displays the units of microseconds (μs) used for the Sync Shift setting

SYNC SHIFT

Use Sync Shift to open the keypad and enter the number of Sync Shift Time Units you want to offset the sensor from the external sync signal. Use this setting to resolve synchronization issues on set such as when working with LED Volumes.

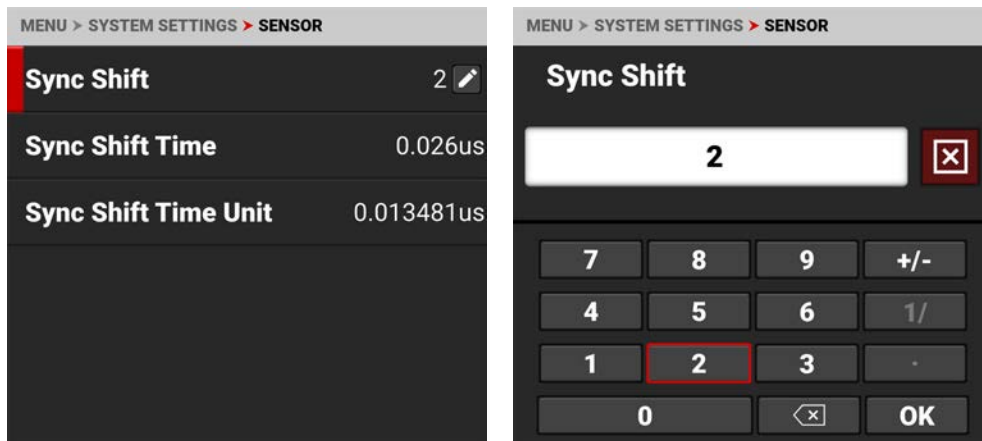

In this example, the Sync Shift is 2 x 0.013481 microseconds ≈ 0.026 microseconds.

INDICATORS

Use the Indicators menu to enable or disable sound and the tally light (refer to the [Camera Body](#) section for more information about the camera LEDs), and to select the record start indicator and record stop indicator sounds.

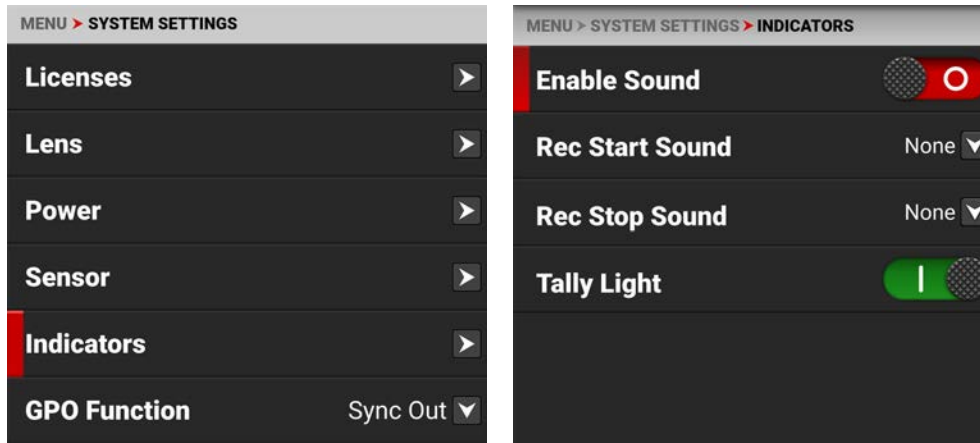

ENABLE SOUND

Use Enable Sound to allow the selected sounds to play.



REC START SOUND

Rec Start Sound allows you to select the sound to play when you begin a recording.

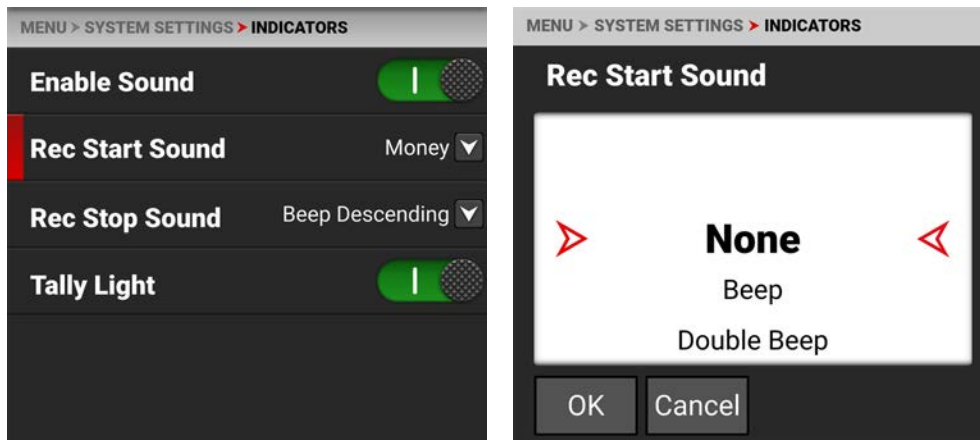

The sounds you can select include:

- None
- Beep
- Double Beep
- Beep Ascending
- Beep Descending
- Money
- Shutter

REC STOP SOUND

Rec Stop Sound allows you to select the sound to play when you end a recording.

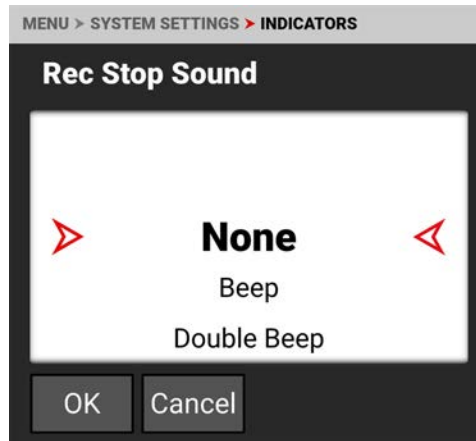
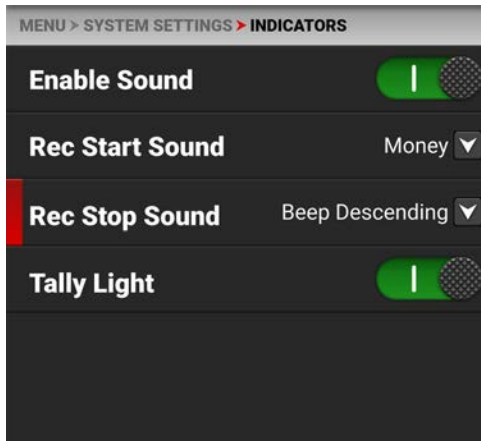

The sounds you can select include:

- None
- Beep
- Double Beep
- Beep Ascending
- Beep Descending
- Money
- Shutter

TALLY LIGHT

Use Tally Light to enable or disable the front recording tally LED.



For more information, refer to the [Camera Body LED](#) section.

GPO FUNCTION

Use the GPO Function menu to select the General Purpose Out function of the Extension port.

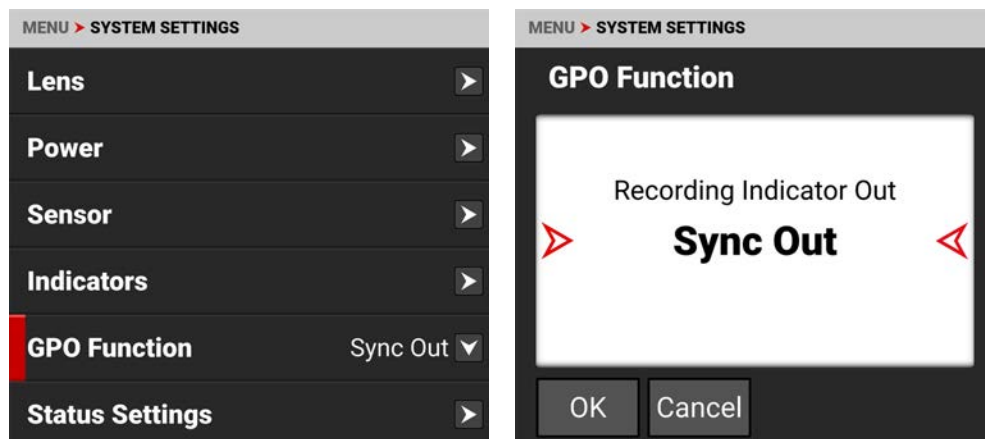

You can select the following General Purpose Out functions for the Extension port:

- Recording Indicator Out
- Sync Out

RECORDING INDICATOR OUT

The Recording Indicator Out function sends a signal out of the Extension port GPO pin when the camera is recording.

SYNC OUT

The Sync Out function sends a Sync signal out of the Extension port GPO pin.

For more information, refer to [Extension Port](#).

STATUS SETTINGS

Use the Status Settings menu to select the shutter display mode, aperture increment, and focus distance units displayed in the camera's menus.

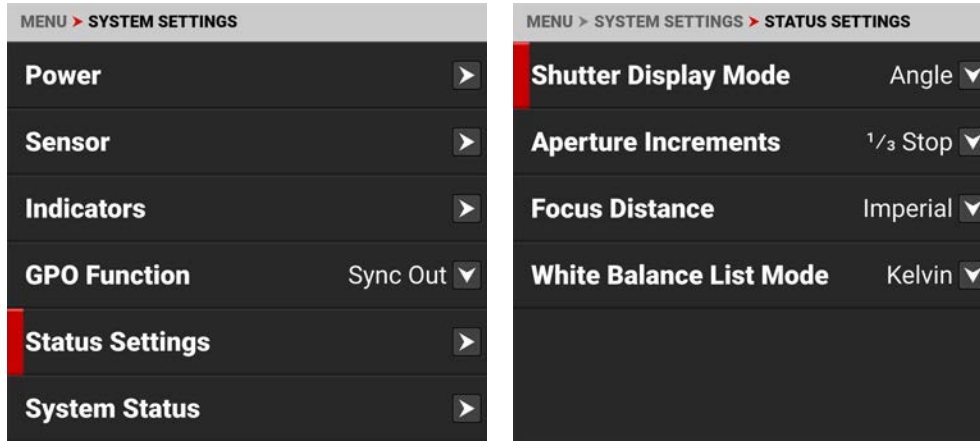

The Status Settings that you can configure include:

ITEMS	DETAILS
Shutter Display Mode	Select a time-fraction or an angle for the shutter menu display unit
Aperture Increments	Select 1/4 or 1/3 f-stop increments
Focus Distance	Select the focus distance units (Metric or Imperial)
White Balance List Mode	Select Kelvin or White Balance Presets
ND Display Mode	When attached, select ND filter Stops or Density display modes
ND Increments	When attached, select the ND increment size

SHUTTER DISPLAY MODE

Use Shutter Display mode to select the way that the camera displays the **Shutter** setting in the menu.

When select Angle, the **Shutter** menu displays the choices in degrees. When you select Time, the Shutter menu displays the choices in fractions of a second.

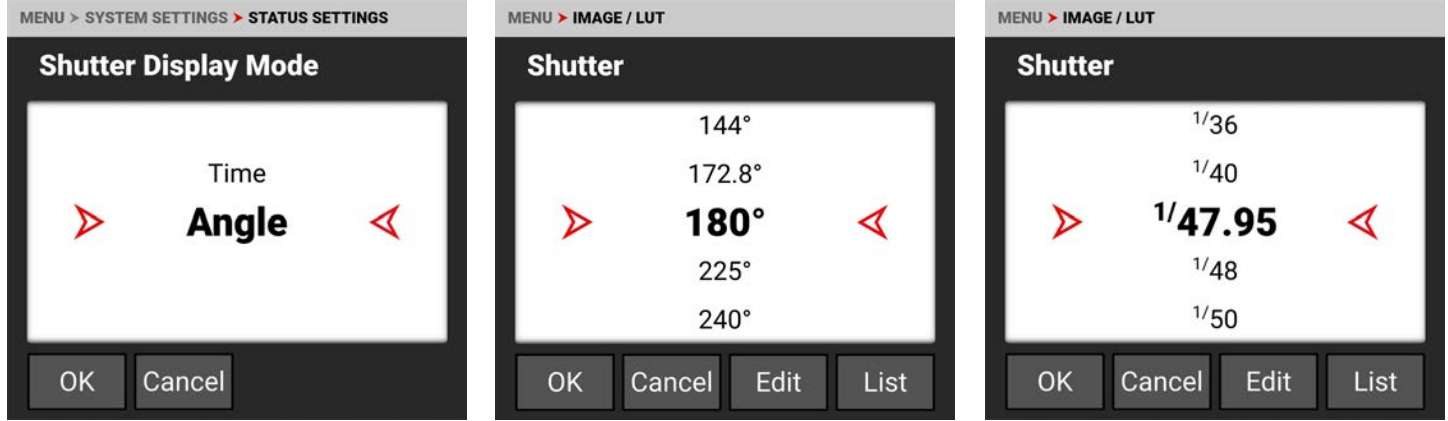

APERTURE INCREMENTS

Use Aperture Increments to select one fourth increments or one third increments for the camera f-stop settings. The default is 1/3 Stop.

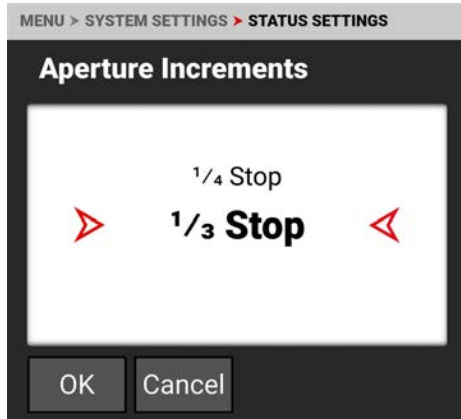

FOCUS DISTANCE

Use Focus Distance to select Imperial or Metric units for the **Lens** Focus Distance display. The default is Imperial.

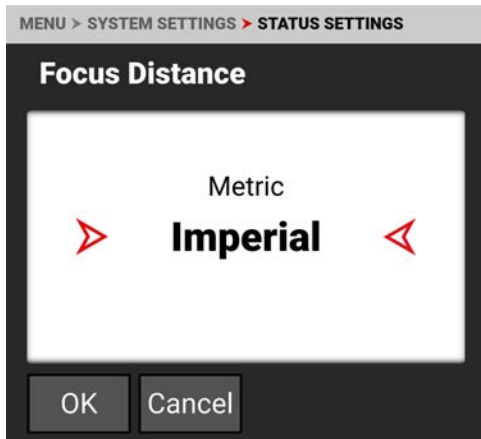

WHITE BALANCE LIST MODE

Use White Balance List Mode to select Kelvin or Presets for the White Balance Color Temperature menu. The default is Kelvin.

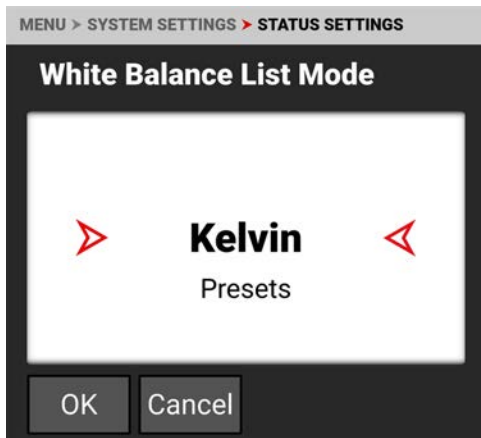

ND DISPLAY MODE

Use ND Display Mode to select Stops or Density display modes when displaying ND settings.

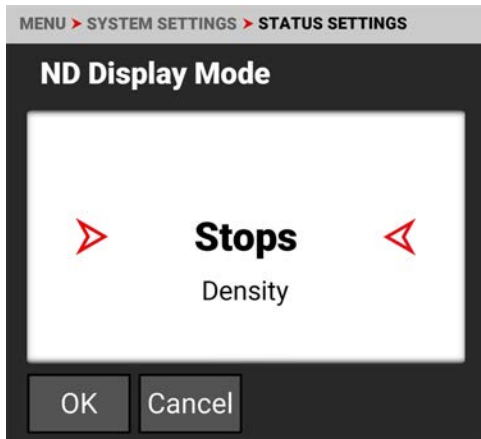

ND INCREMENTS

Use ND Increments to set the increment size for increasing or decreasing the ND stop.



SYSTEM STATUS

Use the System Status menu to view camera information and to view temperature readings.

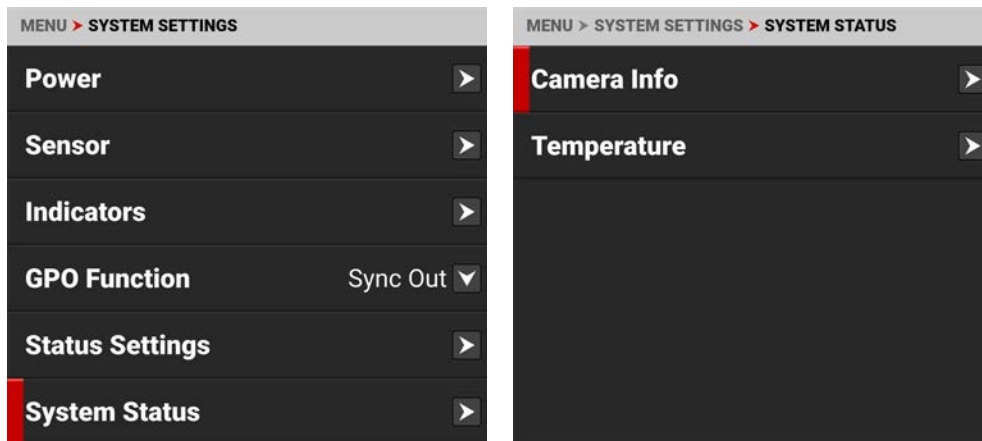

The system status information you can view includes:

ITEMS	DETAILS
Camera Info	Camera information
Temperature	Camera temperatures

CAMERA INFO

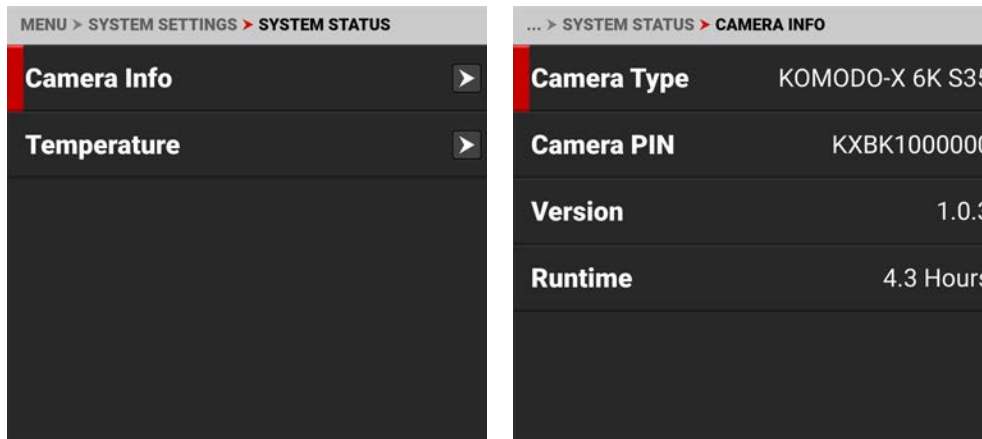

The camera information you can view includes:

ITEMS	DETAILS
Camera Type	Displays the camera description
Camera PIN	Displays the camera personal identification number (PIN)
Version	Displays the firmware version number installed on the camera
Runtime	Displays the total number of hours that the camera has run

TEMPERATURE

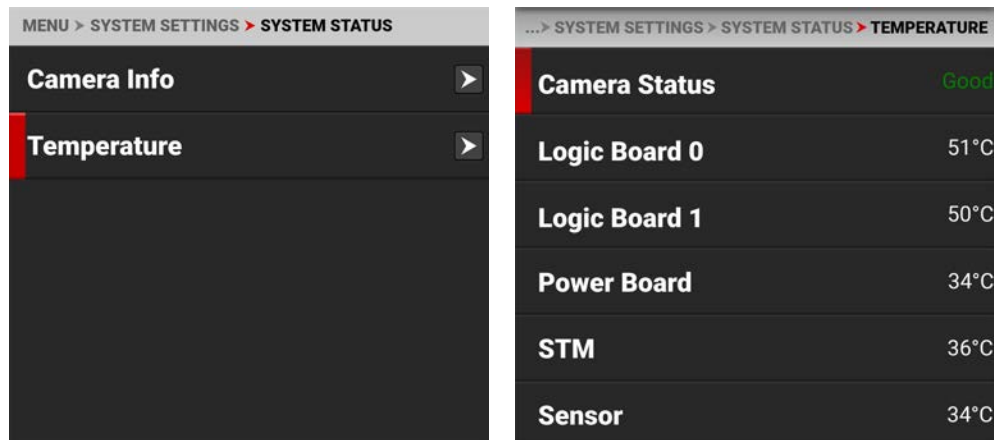

The camera temperatures you can view include:

ITEMS	DETAILS
Camera Status	Displays Good (green) or Overheating (yellow)
Logic Board 0	Displays the Celsius temperature of Logic Board 0
Logic Board 1	Displays the Celsius temperature of Logic Board 1
Power Board	Displays the Celsius temperature of the power IC board
STM	Displays the Celsius temperature of the power STM IC
Sensor	Displays the Celsius temperature of the sensor
Calibration Temperature	Displays the Celsius temperature of the sensor at the last calibration

LANGUAGE MENU

The Language menu contains the languages you can select for the user interface (UI).

From the Onboard LCD touchscreen menu, tap Language:

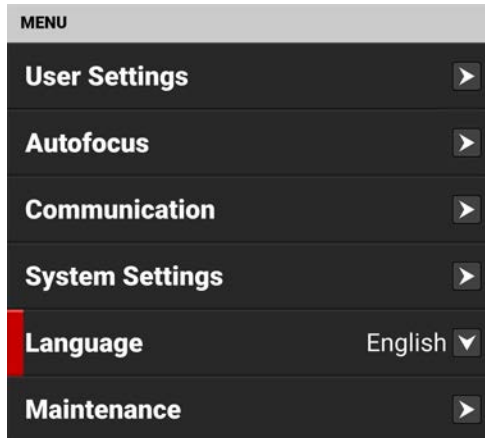

The languages you can select include:

- English
- Simplified Chinese
- French
- German
- Japanese
- Spanish

MAINTENANCE MENU

The Maintenance menu contains the settings you use to perform various maintenance tasks on your camera.

From the Onboard LCD touchscreen menu, tap Maintenance:

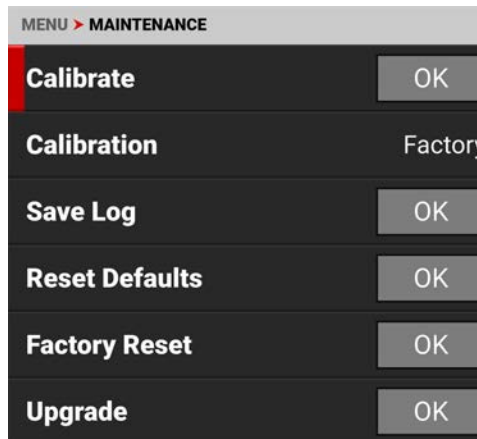
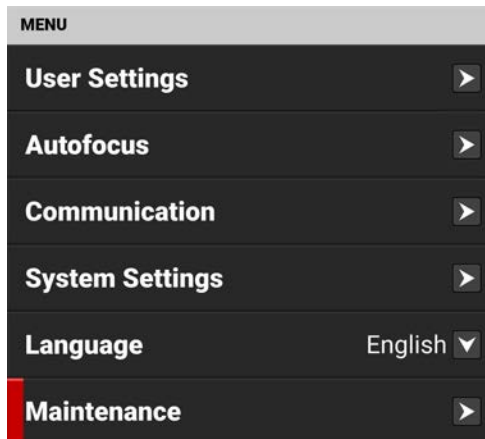

Use the Maintenance menu to perform the following camera maintenance tasks:

ITEM	DETAILS
Calibrate	Performs calibration
Calibration	List of calibration options
Save Log	Saves the camera log files to the media
Reset Defaults	Resets the camera settings to their default settings
Factory Reset	Restores the camera to the factory settings
Upgrade	Updates the firmware

CALIBRATE

Use Calibrate to start the camera calibration process and create your User calibration profile.

Only calibrate the camera after it has reached its operational temperature. This occurs usually within ten minutes after you turn on the camera in the filming environment. Do not calibrate immediately after powering on.

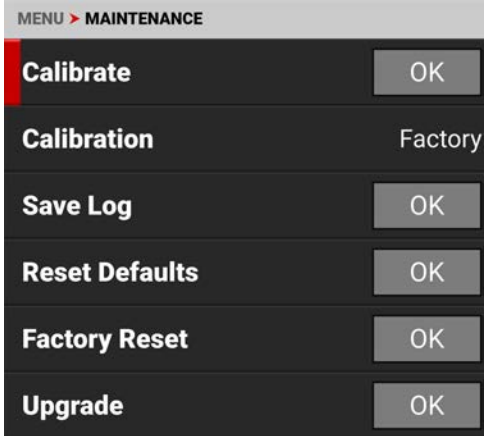

NOTE: Make sure that the mount cap is installed on the camera before you calibrate the camera.

Tap OK on the touchscreen to begin calibrating the camera.

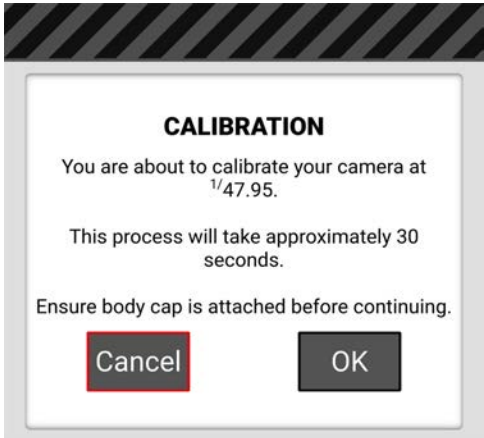

When the camera is finished calibrating, the touchscreen displays the Calibration status message:



CALIBRATION

Use Calibration to select the active camera Calibration.

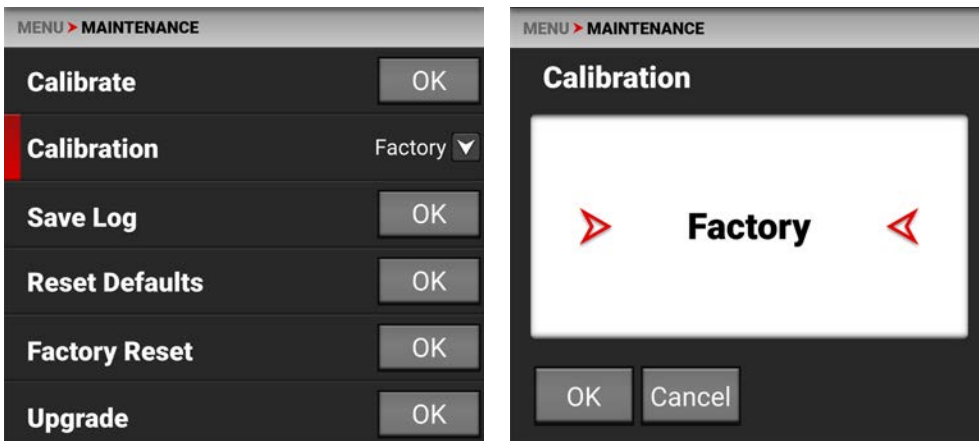

You should always select User calibration. The first time you calibrate the camera, the only choice is Factory. After you perform a calibration, the User calibration profile is added to the list and the camera makes it the default calibration. Every time you calibrate the camera, the User profile is updated. The only time the User profile is removed, is when you perform a Factory Reset.

If User calibration is not available, the camera defaults to Factory calibration. Calibrate the camera to generate the new User calibration profile.

SAVE LOG

Use Save Log to save the camera log to the media.

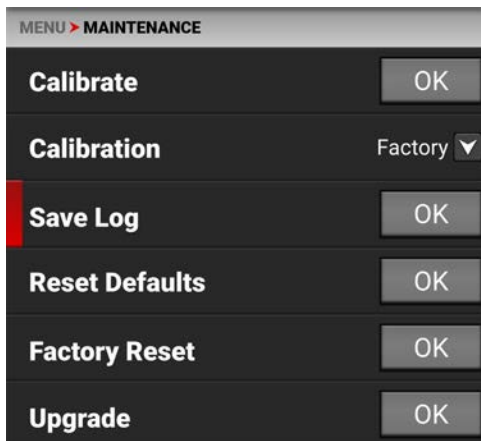

When the media is full, or missing, the camera will display an error message. When there is no error, the success message is displayed.

Error:

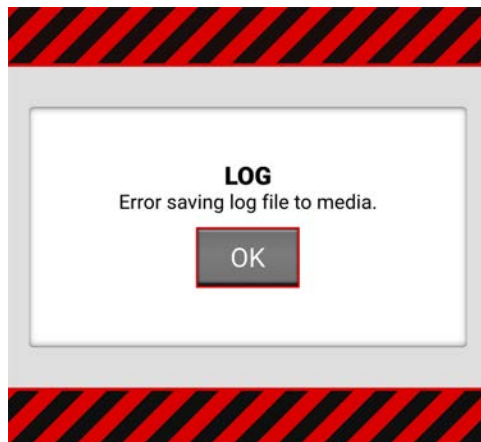

Success:

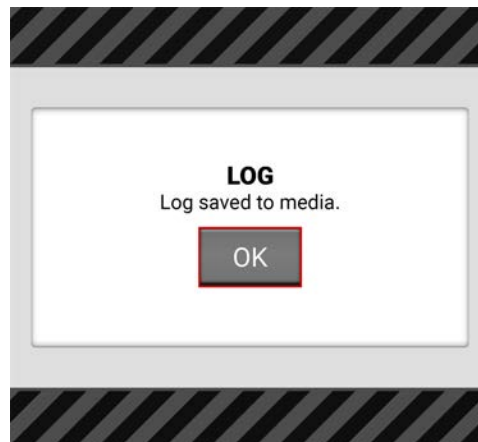

RESET DEFAULTS

Use Reset Defaults to reset the camera to the factory default settings.

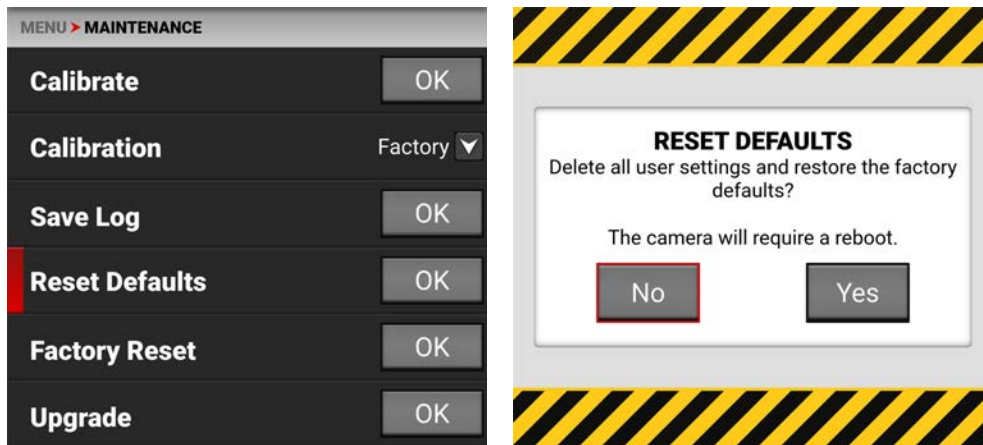

NOTE: Resetting the camera will delete all of your menu settings.

NOTE: The camera turns off, and then back on to complete the reset process.

Tap Yes on the touchscreen to reset the camera menus to the default settings.

FACTORY RESET

Use Factory Reset to reset the camera to the factory settings.

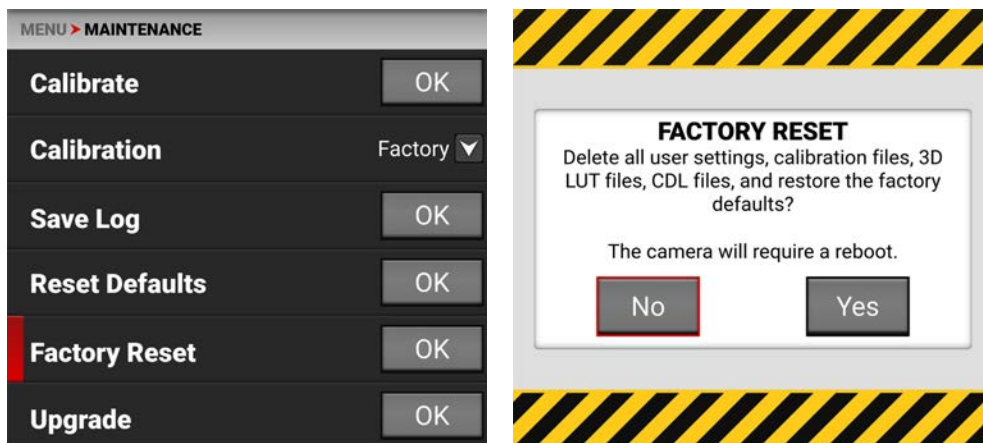

NOTE: Resetting the camera will delete all of your settings and remove all imported files. The camera turns off, and then back on to complete the reset process.

Tap Yes on the touchscreen to reset the camera to the factory settings.

UPGRADE

Use Upgrade to perform a camera firmware update.

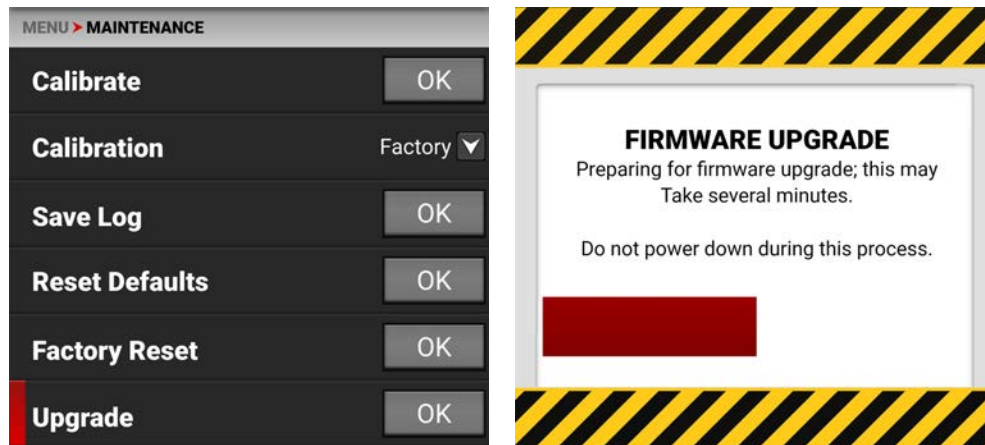

For more information about upgrading the firmware, refer to [Upgrading the Firmware](#).

5. HOW TO

This section describes how you can use the camera features.

WI-FI CONFIGURATION

The camera offers a wireless (802.11g) connection that provides communication support for third-party applications. As with all wireless devices, the communication range varies with the environment and any radio frequency (RF) interference that may be present. You can select a wireless frequency of 2.4 GHz or 5 GHz. For optimal performance, do not obstruct the antenna with any accessory, mounting plate, or mounting rail.

The camera uses **Ad-Hoc** mode to set up the camera as a Wi-Fi hot spot.

The camera uses **Infrastructure** mode to connect to existing Wi-Fi infrastructure.

CONNECTING WIRELESSLY TO AN EXISTING WI-FI NETWORK

This camera uses the WPA2 Wi-Fi protocol.

1. Navigate to the Wi-Fi menu **MENU > COMMUNICATION > Wi-Fi**.

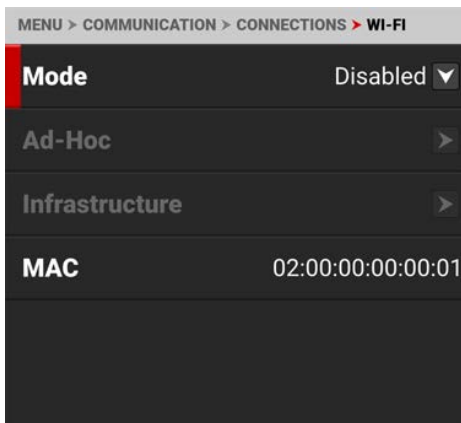

2. From the Mode option, select Infrastructure.

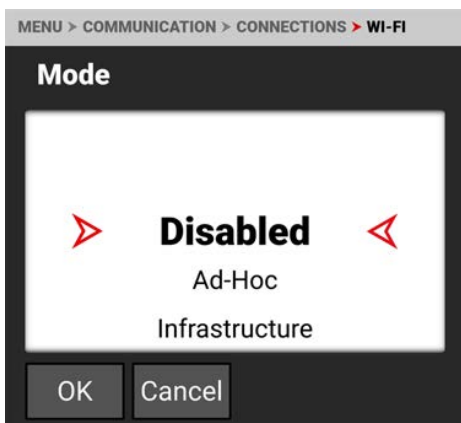

3. From the Infrastructure menu, select Networks:

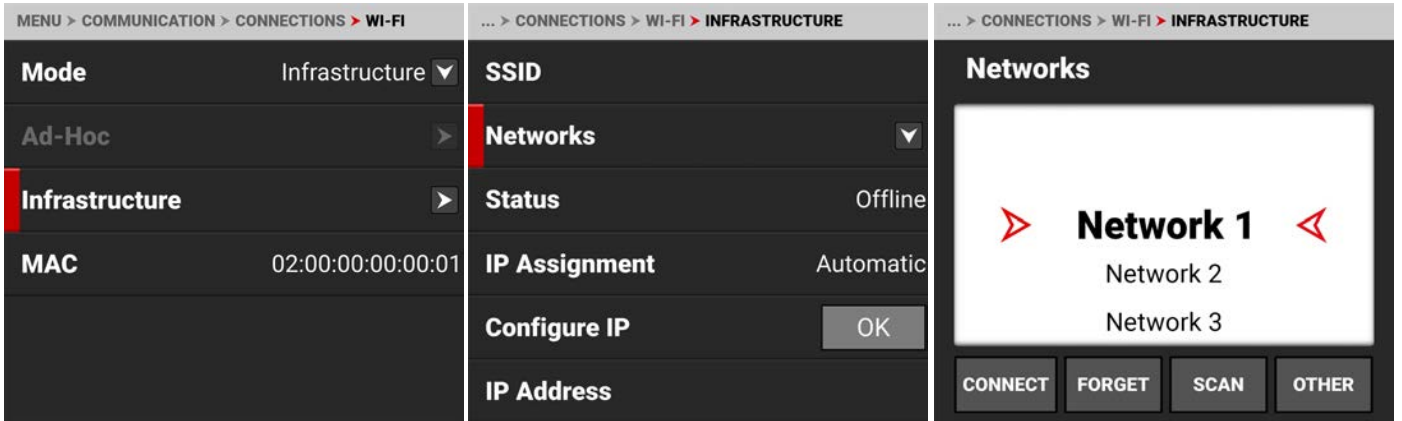

4. Select the network name from the Networks list menu:



or tap SCAN to scan for available networks and update the Networks list:

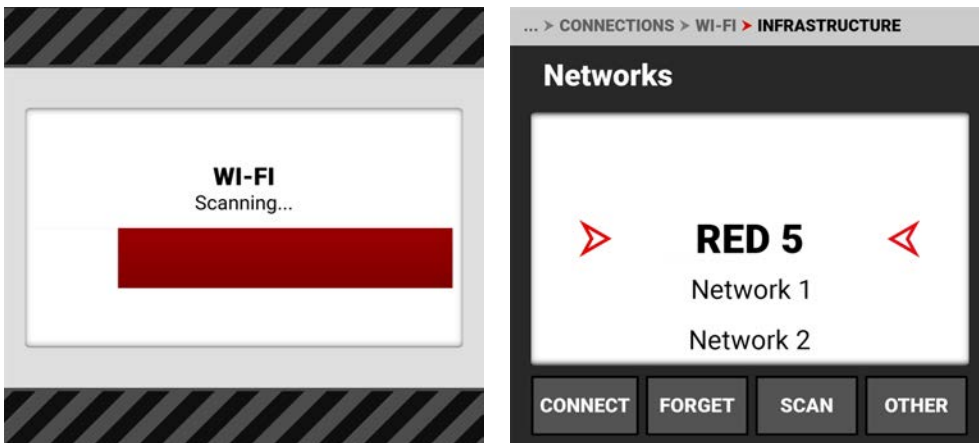

5. Tap CONNECT. The CONNECT screen displays:



6. Tap Passphrase. The Passphrase entry screen displays:

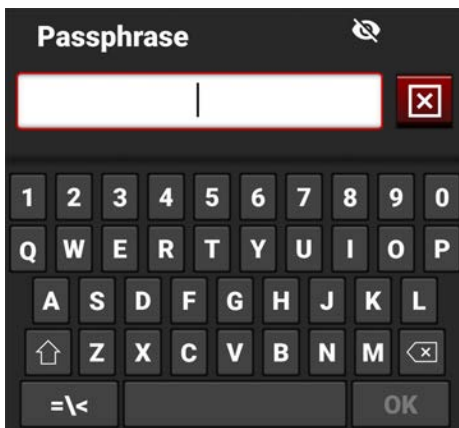

7. Enter the passphrase for the selected network. The passphrase must use a minimum of 8 characters.

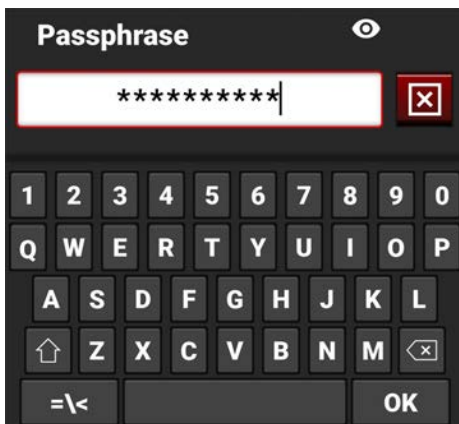

8. Tap OK on the completed Passphrase entry screen. The completed CONNECT screen displays.



9. Tap the Connect button. The camera connects to the selected network:

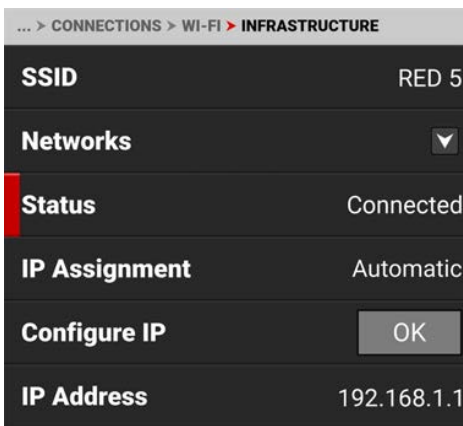

FTPS CONFIGURATION

The File Transfer Protocol Secure (FTPS) offers a fast and secure system for transferring data to and from the camera. FTPS is supported by firmware versions 1.5 and higher. FTPS is available when the camera is enabled and connected to a network over WiFi or through the USB-C port to an Ethernet adaptor.

The settings for using FTPS on the camera include:

- **Protocol:** FTP or FTPS
- **Host:** [IP address of the camera]
- **Port:** 21
- **Encryption:** TLS/SSL Explicit encryption
- **Username:** [Username in FTPS menu settings]
- **Password:** [Password in FTPS menu settings]
- **Logon Type:** Normal

NOTE:

- File transfer speeds may vary depending on the strength of the signal (when using WiFi) and the amount of network traffic. For the fastest and most reliable data transfer, we recommend using a hard-wired connection.
- Steps may differ depending on which FTP software you wish to use, consult your software's user guide for additional assistance.
- When setting up FTP, make sure you use FTP or FTPS and not SFTP as these are different protocols.
- For security reasons, the FTPS host name and password are only displayed on the camera FTPS menu.
- Disabling encryption can increase transmission speeds.

CAMERA SET-UP

1. Connect your camera to the network with the desired connection method (Ad-Hoc, Infrastructure or USB-C) and verify the connection. A successful connection is confirmed when the camera displays an IP address in the WiFi or USB-C settings menus.

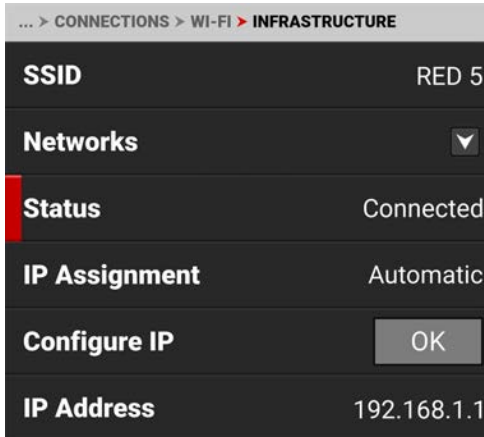

2. Navigate to Menu > Communication > Clients & Services > FTPS. Take note of the username and password. You can also enter a new password QR code.

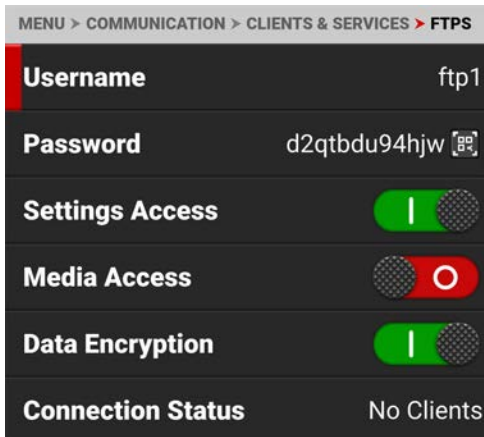

3. Enable the permissions you want users to have access to by toggling Settings Access or Media Access to the on or off position. The media folder will display as an empty folder on the FTP App when Media Access is disabled (off).
4. The camera is now set-up on FTPS.

SOFTWARE SET-UP (FILEZILLA)

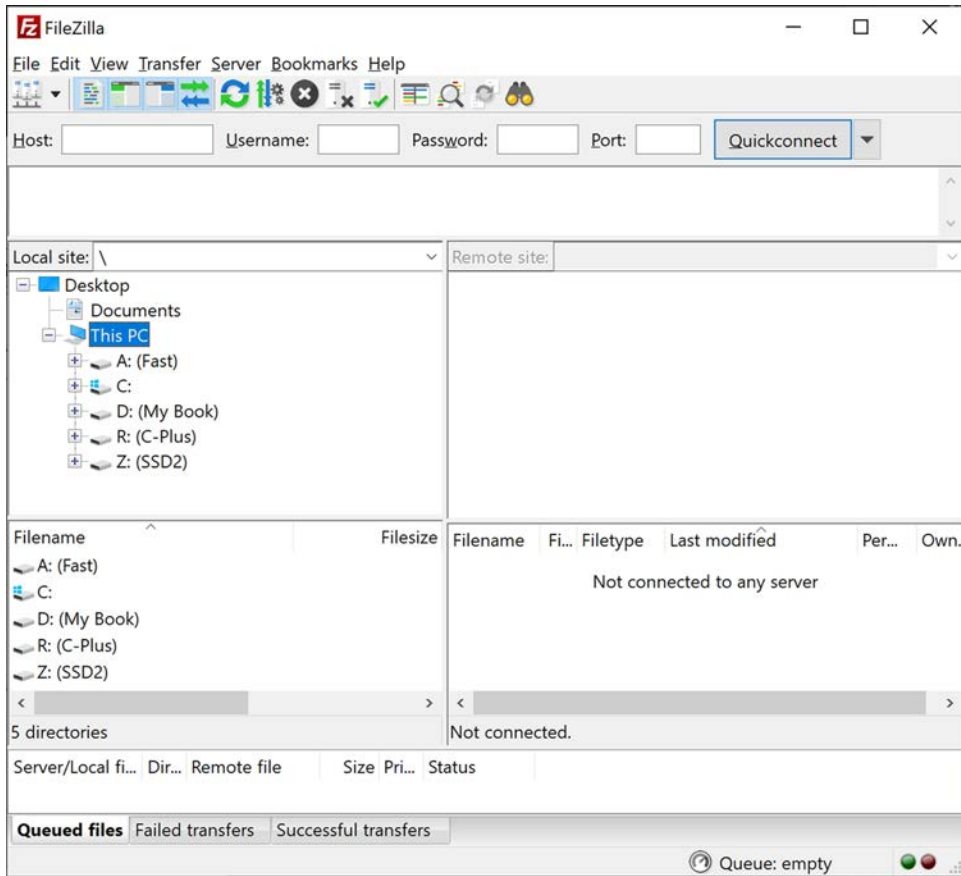

1. In FileZilla, enter the following settings:

- Host: *ftp://Camera's IP Address - Example: ftp://192.168.1.93*
- Username: Username displayed in the camera's FTPS menu
- Password: Password displayed in the camera's FTPS menu
- Port: leave blank

2. Press Quickconnect. Depending on the permissions you will now have access to the desired folders.

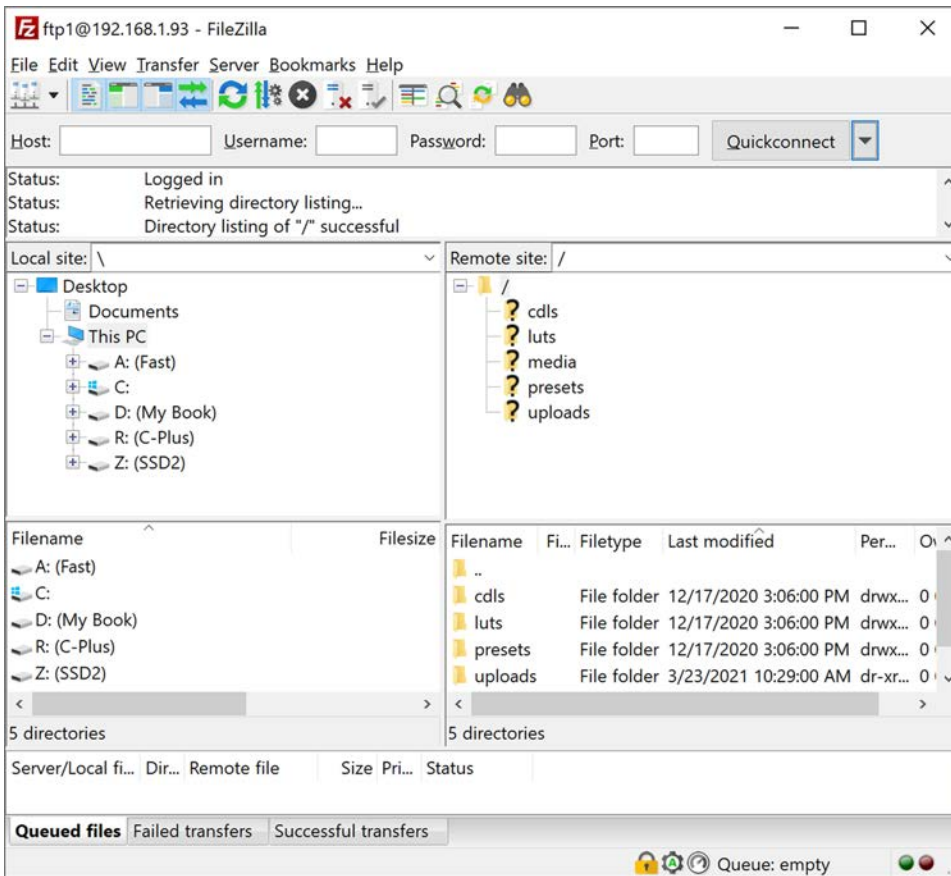

The camera FTPS menu Connection Status displays Connected:

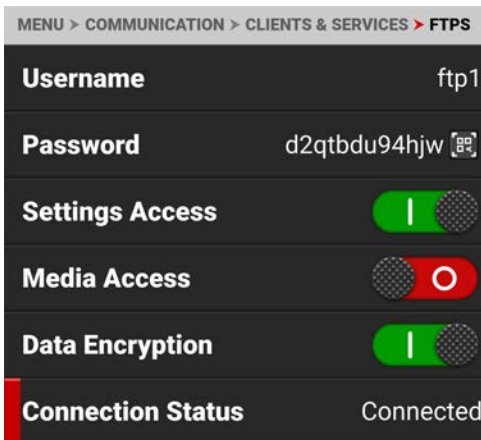

ADDITIONAL INFORMATION

When uploading files to the camera make sure that you use the 'upload' folder & then the desired sub-directory of luts, cdl, presets or upgrade. Media cannot be uploaded to the camera.

The data rate of the FTPS transfer with encryption maxes out at roughly Gigabit Ethernet speeds.

Estimated download time for a full 256 GB is approximately 47 minutes when using a wired connection.

USB-C CONFIGURATION

KOMODO-X offers a USB-C 3.0 protocol connection that provides communication support for Android devices, Apple devices, Ethernet devices, and R3D streaming with the RED Connect License (with 5 Gb/s Ethernet adapter).

For more information about RED Connect refer to: [RED Connect](#).



This section includes instructions for:

- [USB-C Android Configuration](#)
- [USB-C Apple Configuration](#)
- [USB-C Ethernet Configuration](#)

USB-C APPLE CONFIGURATION

The KOMODO-X offers a USB-C 3.0 protocol connection that provides communication support for Apple devices.

CONNECTING TO AN APPLE DEVICE

1. From the Apple store, download the **RED Control Apps** to the Apple device.

Note: Scroll to the bottom of the user agreement to accept the agreement.



2. Connect the Apple device to the camera with a USB-C cable. If the "Trust This Computer?" message displays, skip to step 6.

3. Open the Apple device settings by tapping the Settings icon.



4. Select Personal Hotspot.

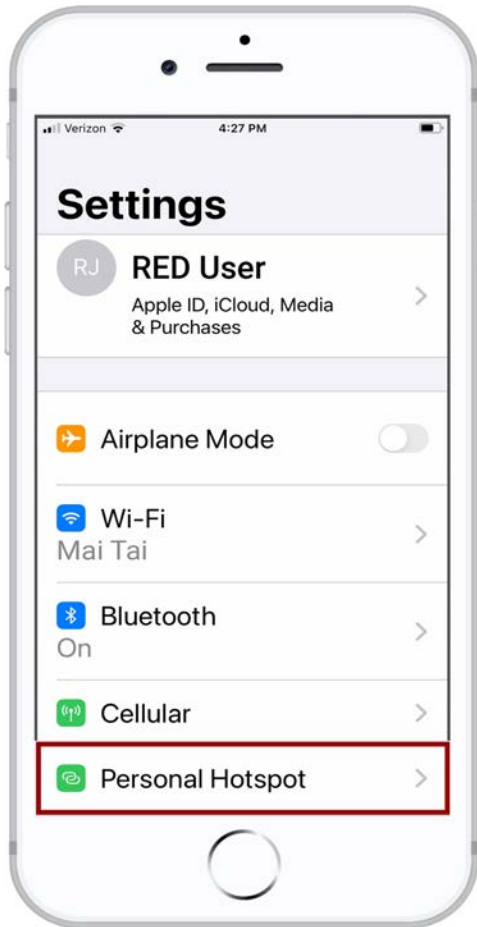

5. Allow others to join.



6. The Apple device prompts you to acknowledge that you trust the computer (camera).

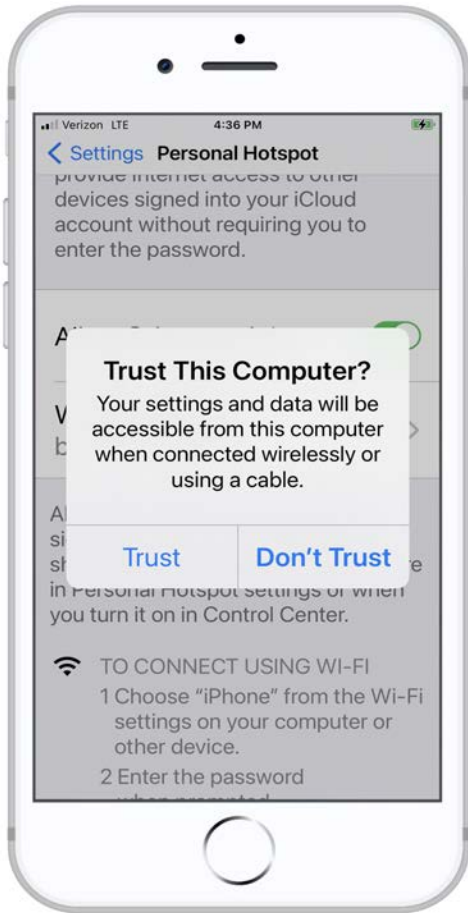

7. From the Apple device, tap the RED Control icon to open the RED Control app.



The RED Control app displays the camera connection icon. The word LINK is visible after the IP address.

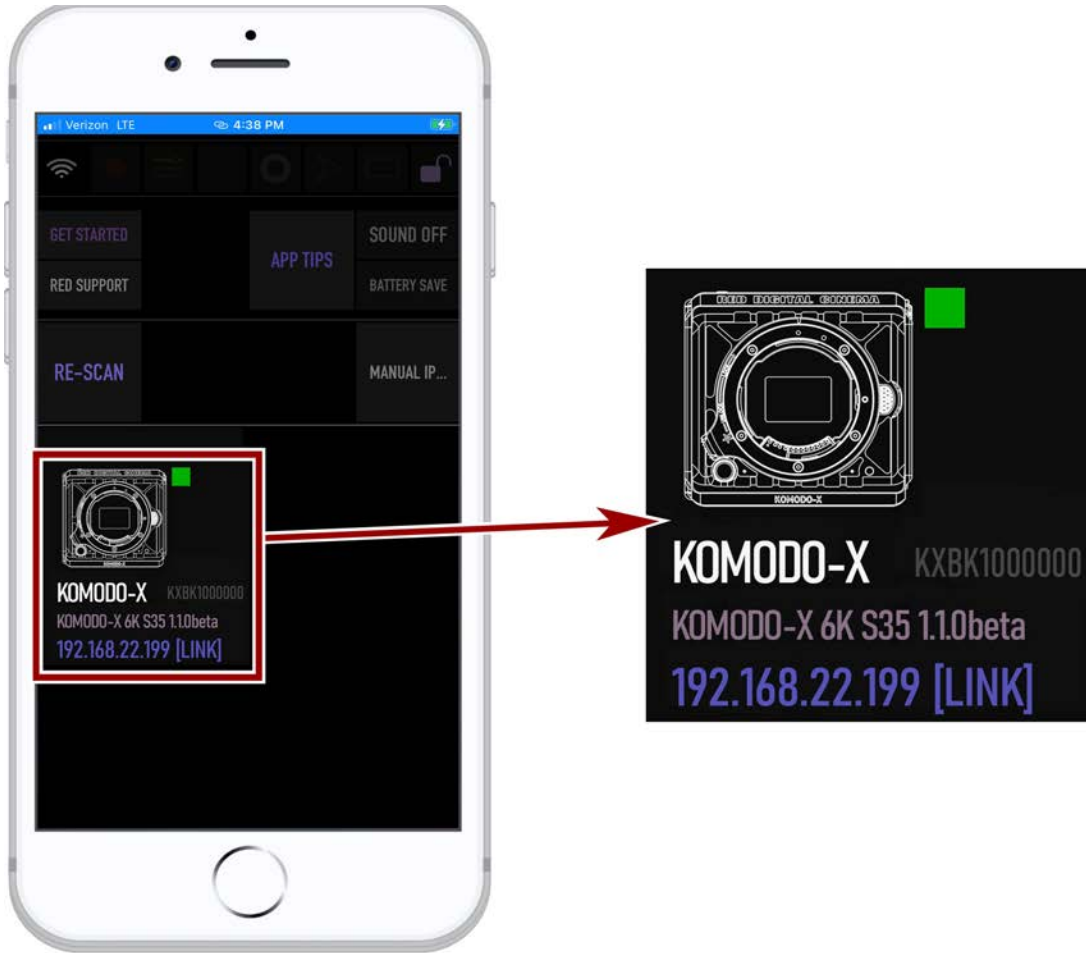

8. Tap the icon to open the RED Control app tools for the connected camera.



From here you can use the RED Control Apps to monitor and control the camera.

USB-C ANDROID CONFIGURATION

The KOMODO-X offers a USB-C 3.0 protocol connection that provides communication support for Android devices.

CONNECTING TO AN ANDROID DEVICE

1. From the Google Play store, download the **RED Control App** to the Android device.

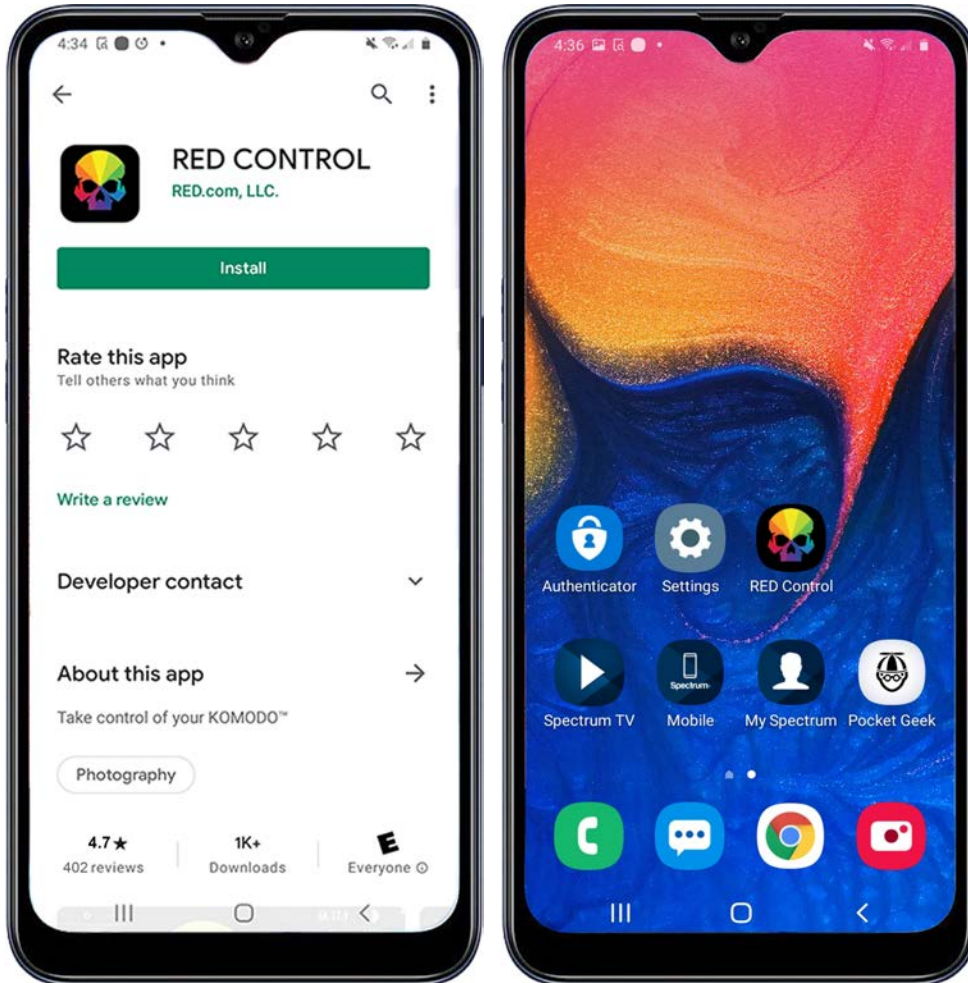

2. Connect the Android device to the camera with a USB-C cable.

3. Open the Android device settings by tapping the Settings icon (gear).



4. Select Connections.

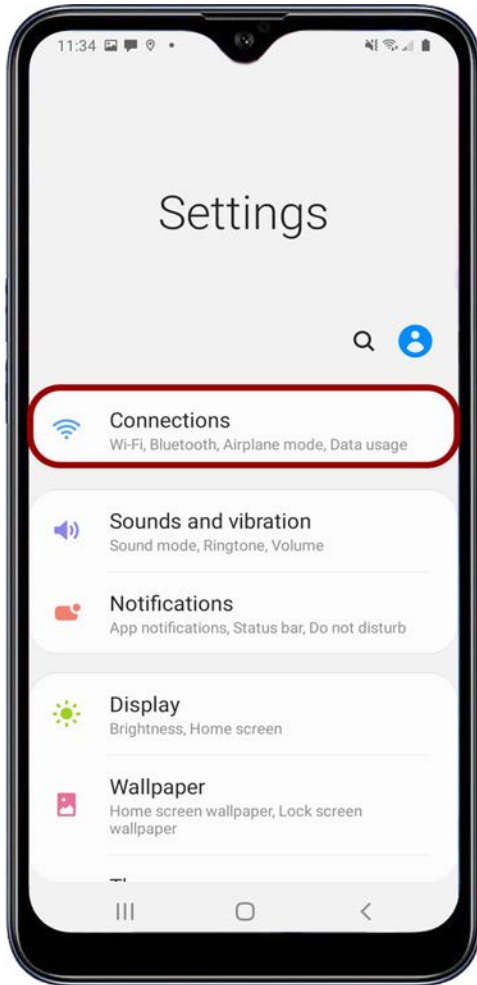

5. Select Mobile Hotspot and Tethering.

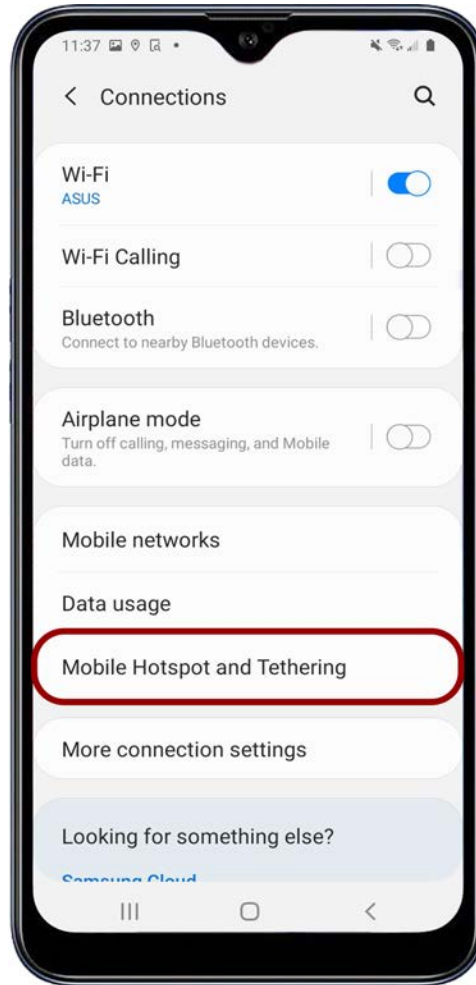

NOTE: Mobile Hotspot and Tethering is only available on Android devices with cellular capability.

6. Enable USB Tethering.

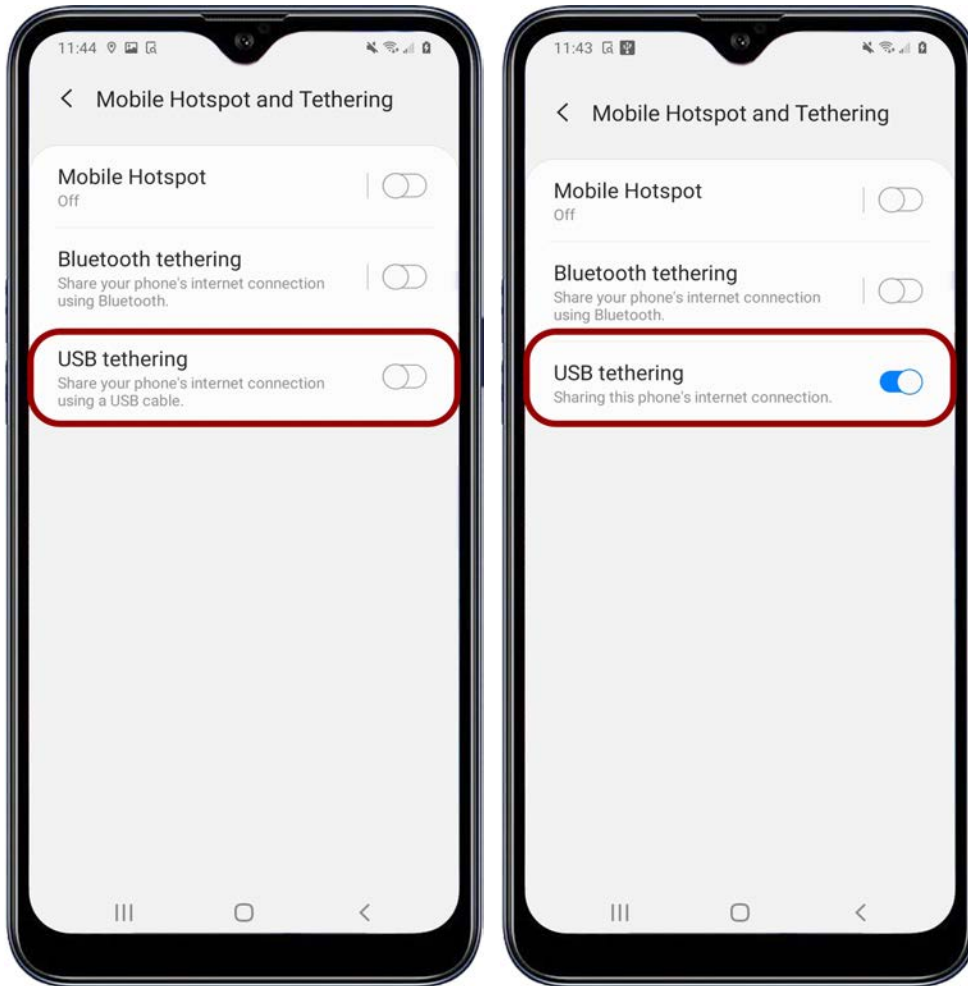

7. From the Android device, tap the RED Control icon to open the RED Control app.



The RED Control app displays the camera connection icon.

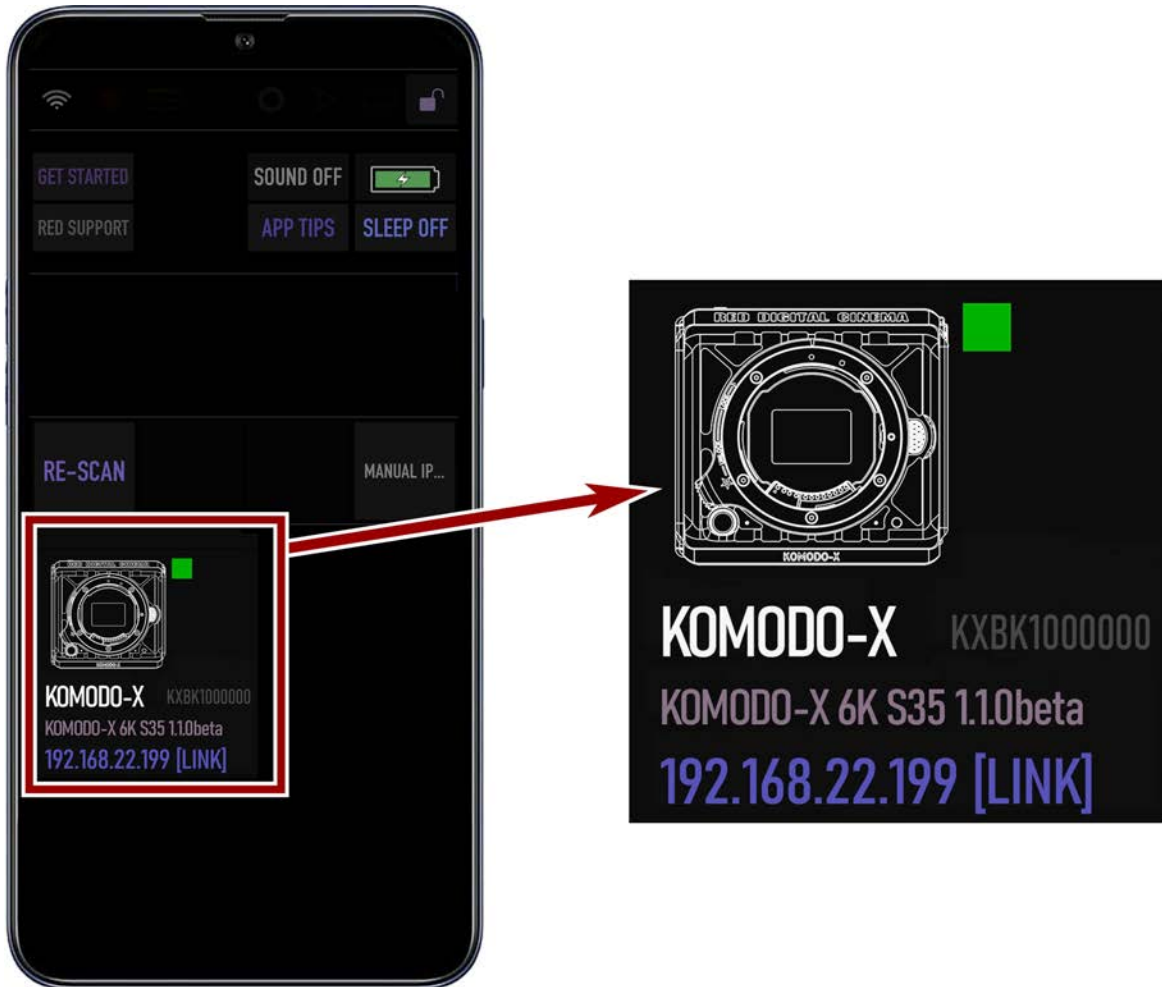

8. Tap the icon to open the RED Control app tools for the tethered camera.

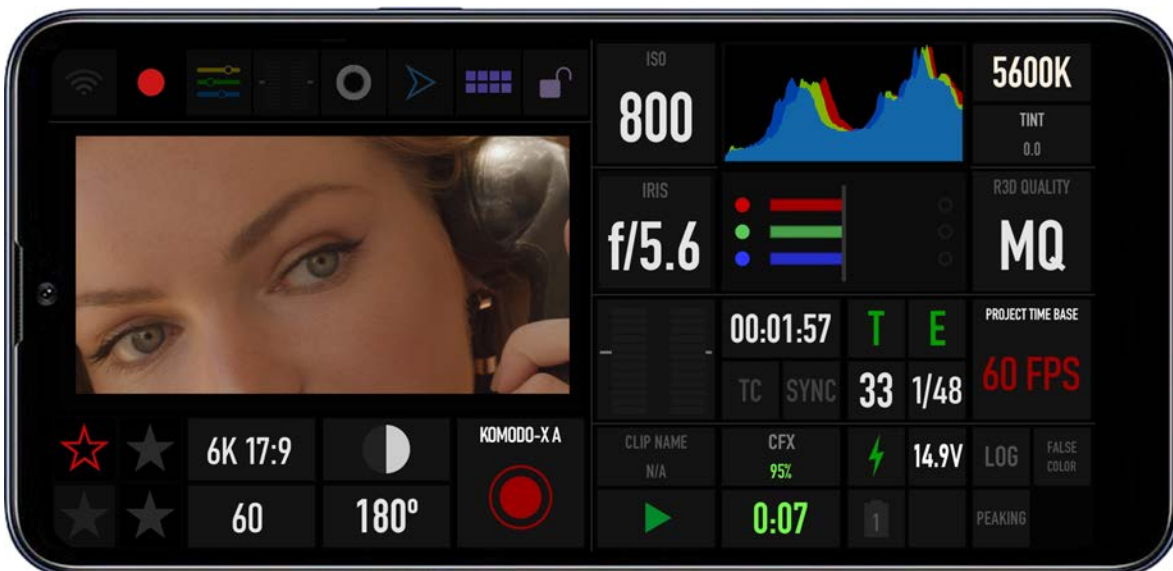

From here you can use the RED Control App to monitor and control the camera.

USB-C ETHERNET CONFIGURATION

The KOMODO-X offers a USB-C 3.0 protocol connection that provides communication support for Ethernet networks.

CONNECTING TO AN ETHERNET NETWORK

You must use a USB-C to Ethernet adapter to connect the camera to an Ethernet network.

1. Connect the camera to the Ethernet network using the USB-C to Ethernet adapter.
2. From a Wi-Fi-enabled device, select the Wi-Fi connection to which the camera is connected.



3. Open RED Control on the Wi-Fi-enabled device.

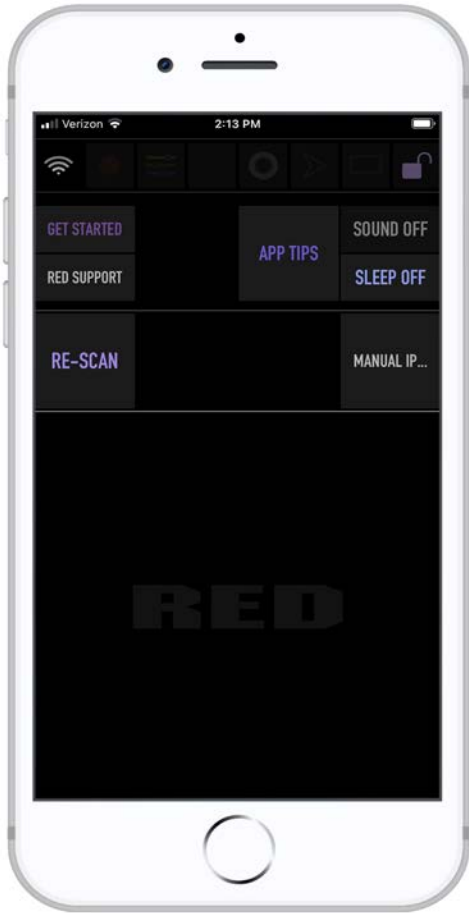

4. Tap RE-SCAN.
The camera icon displays.

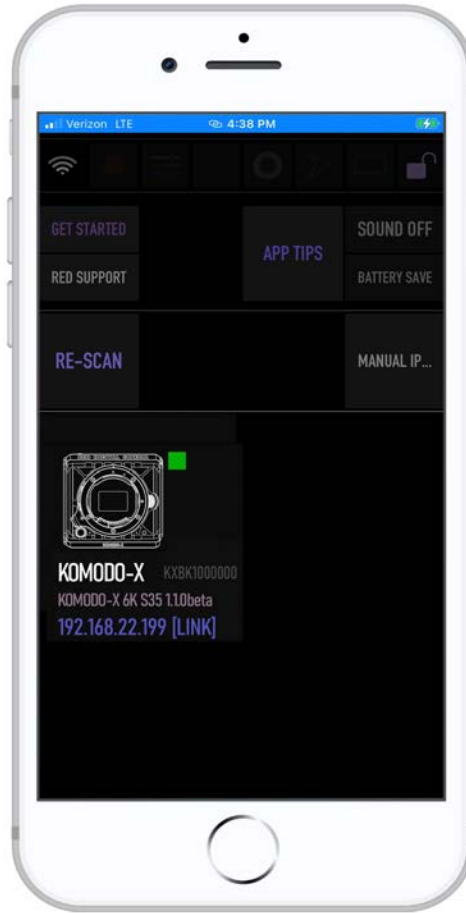

The camera icon displays the camera's Ethernet IP address:



5. Tap the camera icon to open the RED Control app tools for the networked camera.



6. Open a browser from a computer connected to the Ethernet network.

7. In the browser address field, enter the camera IP address displayed on the RED Control camera icon or the camera Communication menus (Ad-Hoc, Infrastructure). The RED Control tools are displayed in the browser.

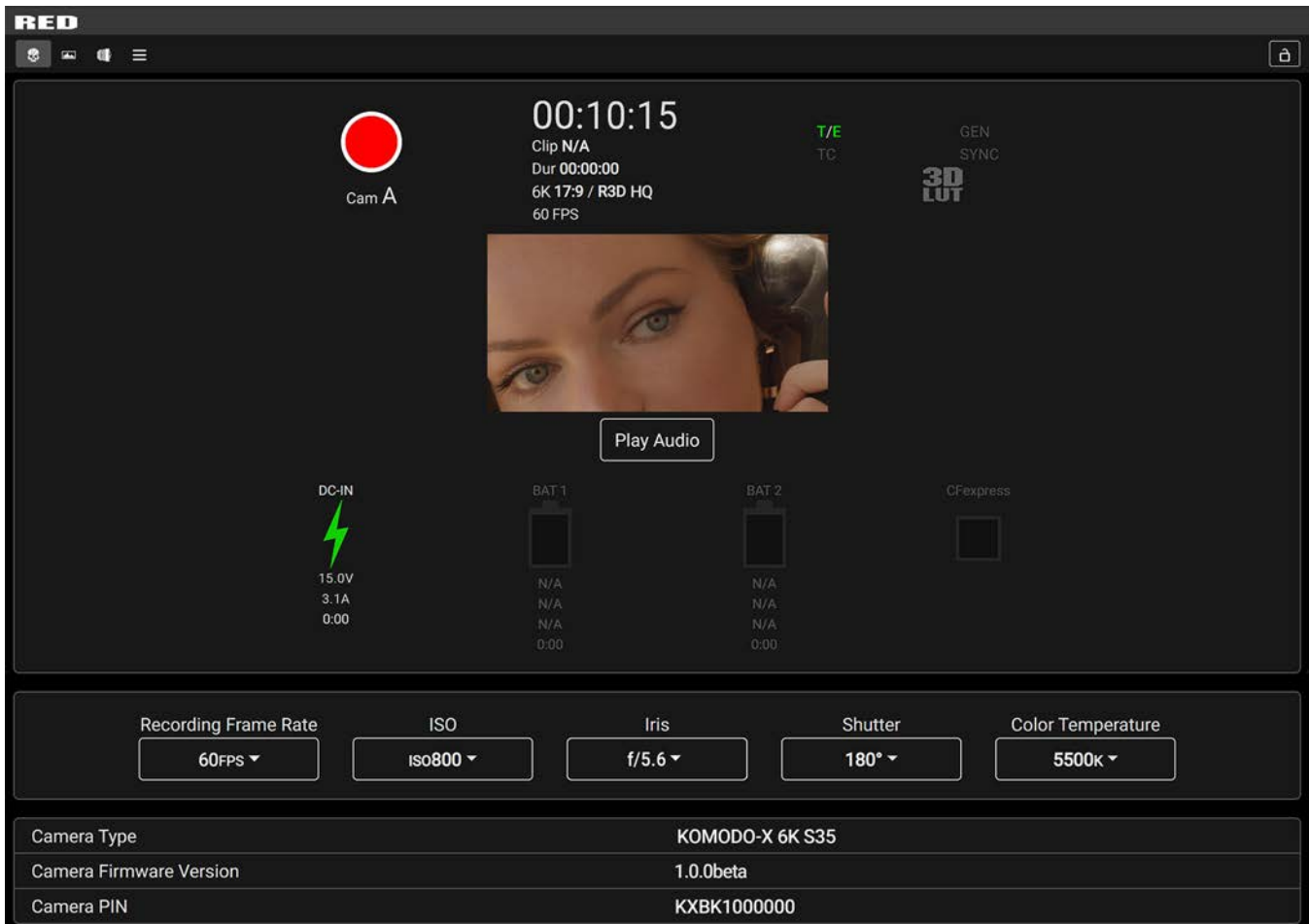

POWER

The camera accepts power through a DC-IN port and through an attached battery. The camera cannot accept power through USB, or BNC ports. For more information, refer to [6-pin DC-IN](#), [KOMODO-X™ Power Adaptor](#), [REDVOLT® NANO-V Battery](#), and [REDVOLT® MICRO-V Battery](#).

ATTACHING THE BATTERY

Attach a compatible V-Lock battery (refer to [REDVOLT® NANO-V Battery](#) and [REDVOLT® MICRO-V Battery](#)) in the V-Lock battery mount. Slide the battery down until the locking mechanism clicks.



V-Lock batteries with a width greater than 2.95 in. (75 mm) are not compatible with the camera's Micro V-Lock plate and will require a battery adapter.

The camera can charge the installed battery when the camera is off and the DC power Adaptor is connected. The camera charges the batteries only when the camera is off and the power Adaptor is connected. While the battery is charging the DC Power LED blinks amber until communication is established. The LED is solid amber when communication is established and the battery is charging. The LED is green when communication is not established (incompatible battery) and the battery

is not charging.

NOTE: An incompatible battery will not charge on the camera.

REMOVING THE BATTERY

Remove the battery when the charge is low or when you are storing the camera.

1. Turn off the camera.
2. While holding the attached battery, press the battery **Eject Button**.
3. Slide and lift the battery up.

POWER COMPONENTS

You can power the camera with the [KOMODO-X™ Power Adaptor](#), an External DC Power Source, or with a rear-mounted [REDVOLT® MICRO-V Battery](#) or [REDVOLT® NANO-V Battery](#).

For information about charging, storing, or maintaining the batteries, refer to the manufacturer's instructions.

AUTO BOOT ON POWER

The camera supports the Auto Boot on Power feature. This means that if all power sources are removed, and the Power Switch is set to ON, then when a power source is attached, the camera turns on.

POWER CONSUMPTION

The camera draws various levels of power depending on the configuration and operating conditions. When there are no auxiliary (AUX) power draws on the camera, the power consumption guidelines are:

- 28 Watts of power in the camera's basic recording configuration at room temperature, 6K, and 24 frames per second
- 45 Watts of power when using DSMC3 RED Touch 7", at room temperature, 6K, and 80 frames per second

POWER PRIORITY

When multiple power sources are connected to the camera, power consumption is prioritized in this sequence:

1. Any power supply connected to the DC IN port.
2. Attached V-Lock battery.

WARNING: Always attach the power or battery before attaching the SDI BNC cable. Always remove the SDI BNC cable before removing the power or battery.

TURNING ON THE CAMERA

1. Attach a power source (**REDVOLT[®] MICRO-V Battery** or **DC-Input**) to the camera.
2. Slide the **Power Switch** up to the **ON** position.



TURNING OFF THE CAMERA

NOTE: Do not turn off the camera while the camera is recording, or formatting media.

Slide the **Power Switch** down to the **OFF** position.



MEDIA MANAGEMENT

This section explains how to use, record, format, and offload media for the camera.

WARNING: Do not attach a label to the media card. The heat generated by the media can weaken the label's adhesive, causing the label to detach inside of the camera. Labels can also diminish heat dissipation and cause excessive wear to the internal components. Removing a label from a media card can possibly deform the card body.

The camera supports exFAT as the file system for the media card to accommodate larger files and data rates. exFAT is supported both on macOS and MS Windows.

Format your media in the camera whenever possible (refer to [Media Best Practices](#)).

EJECTING (UNMOUNTING) MEDIA

IMPORTANT: To ensure data integrity, media must always be ejected (unmounted) prior to removal from the camera. This ensures that power is removed from the media and any open data files are closed. Failure to properly eject (unmount) media may result in lost data or corrupted files.

To eject (unmount) media from the camera, use the [Onboard LCD Touchscreen](#) and select **Menu > Media**.

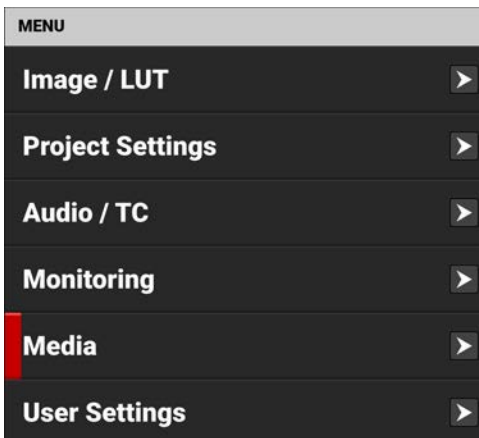

Tap the Eject OK button:

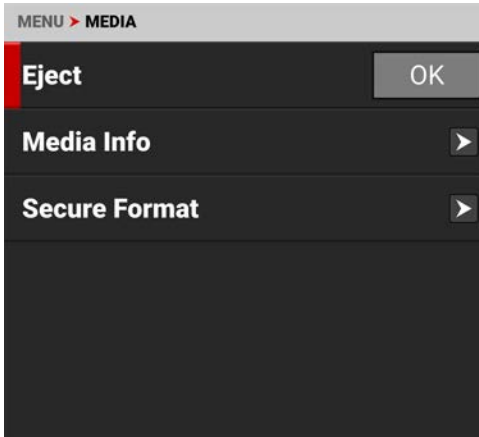

The Success message displays:



The media is now ejected (unmounted) and all media related items are grayed out in the menu.

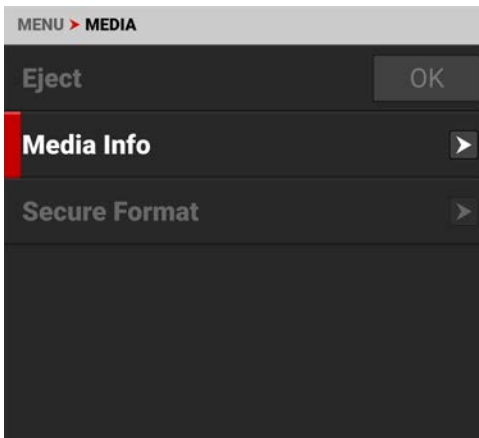

WARNING: The media can get extremely hot. Use caution when removing media.

Removing a media card without ejecting (unmounting) first does not damage the media, however, it does increase the risk of file corruption. It is good practice to eject the media before removing or disconnecting. Ejecting the media provides the following benefits:

- Protects the integrity of your recorded data
- Mounts clips instantly to your workstation in post-production.

INSERTING THE MEDIA

The camera contains a covered compartment on the right side where you insert the CFexpress media card.

WARNING: Do not attach a label to the CFexpress media card. The heat generated by the media can weaken the label's adhesive, causing the label to detach inside of the camera. Labels can also diminish heat dissipation and cause excessive wear to the internal components. Removing a label from a CFexpress media card can possibly deform the card body.



INSERTING THE MEDIA CARD

1. Press the media door latch down, and the media door opens.



2. Insert the CFexpress media card in the slot with the top of the card facing toward the front of the camera. Insert the card until it is firmly seated.

3. Close the media door and make sure that the door latch clicks.

4. If needed, format the CFexpress media card. Refer to [Secure Format](#) for more information.

REMOVING THE MEDIA CARD

NOTE: Do not remove the CFexpress card while the camera is recording or formatting media. Refer to [Media Management](#) for more information.

WARNING: The media can get extremely hot. Use caution when removing media.

1. If the camera is on, go to **Menu > Media** and select **Eject**.
2. Press the media door latch down, and the media door opens.



3. Press the CFexpress media card until you hear a click, and then release the card and it will slide out.



4. Let the CFexpress media card cool before gently pulling the card out of the slot.

WARNING: The media can get extremely hot. Use caution when removing media.

5. Close the media door and make sure that the door latch clicks.

SECURE FORMAT

A secure format is a low-level format that rebuilds the media card file system. A secure format erases all data on the card.

Perform a secure format when the camera is reporting media-related errors.

PERFORMING A SECURE FORMAT

CAUTION: Ensure all data is backed up before formatting a card. **Data erased during formatting cannot be recovered.**

WARNING: The media can get extremely hot. Use caution when removing media.

To perform a secure format, follow the instructions below:

1. Go to **MENU > MEDIA > SECURE FORMAT:**



2. From the Secure Format menu, select the desired **Camera ID**, **Camera Position**, **Reel Number** and **Edgecode**. Tap the Format button to start the Secure Format process:

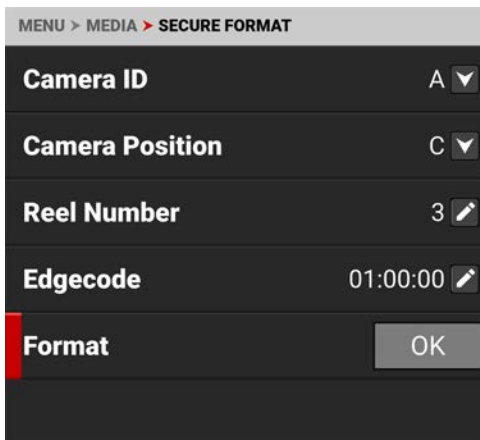

The confirmation message displays:



3. Tap Yes to begin formatting.

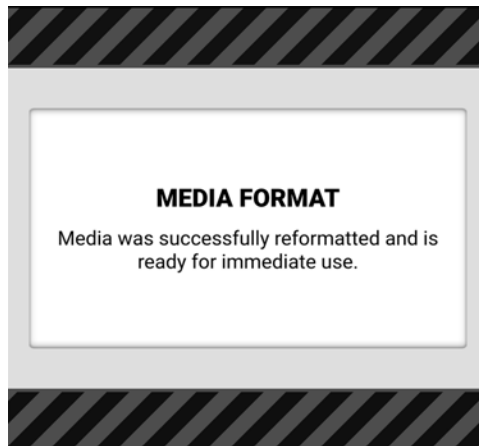

FORMATTING MEDIA ON A COMPUTER

RED recommends that you only format your media card from a computer when you cannot mount the media to the camera (refer to [Media Best Practices](#) for more information).

MEDIA INFORMATION

Use the [Media Info](#) menu to display the media card information.

Media information includes the following:

SETTING	DETAILS
Status	Displays the media card status
Model Number	Displays the media card model number
Serial Number	Displays the media card serial number
Firmware Version	Displays the media card firmware version
Percentage Remaining	Displays the media card's remaining storage*
Time Remaining	Displays the recording time remaining on the media card*

* with the current project settings

FILE SYSTEM

The camera formats the media card using the exFAT file system. Both Mac[®] and Windows[®]-based computers support media cards with this system. Refer to the documentation for your operating system to determine whether there are any limitations to its file system support.

CLIP NAMING CONVENTION

When you record a clip, the camera creates a unique name for the clip folder that uses the format described in the table below:

ITEM	DETAILS	EXAMPLE
Camera ID	The letter assigned to the camera (refer to Camera ID)	A
Reel ID	The reel number assigned to the media (refer to Reel Number)	004
Camera Position	The camera position letter (A-Z) followed by three digits starting with 001 (refer to Camera Position)	C001
Month	Month that the clip is recorded (refer to Date / Time)	12
Day	Day that the clip is recorded (refer to Date / Time)	04
Two Characters	Two random alphanumeric characters generated by the camera to prevent any possibility of duplicates	6M
.RDC	Clip folder extension	.RDC

For example, a sequence of clip folders within a media folder on Camera A may look like this:

- A001_C001_12046M.RDC
- A001_C002_1204CE.RDC
- A001_C003_1204R5.RDC

CLIP METADATA

The following metadata is recorded for each frame of each clip:

- Audio Data
- Broadcast Wave File (BWF)
- Clip
- Configuration, Camera Name, Network, Model, Model ID, Serial Number
- Copyright
- Date and GMT
- Filename
- Firmware Version
- Frame Guides
- Jamsync Setting
- Lens and Shutter Speed/Angle Parameters
- Lens Name, Brand, ID, Near Focus, Far Focus
- Location
- LTC User Bits (3 32-bit word reg-dump from ISP)
- Media Serial Number
- Production Name
- REDCODE[®]
- Reel
- Scene
- Stereo Setup
- Take
- Timecode
- Unit

MEDIA BEST PRACTICES

This section describes best practices to ensure that your media cards continue to provide reliable storage and fast data rates. Following these best practices may prevent your media card from becoming fragmented, which can lead to data integrity errors.

- The only files that should be saved from your computer to your media card are Preset files, Firmware Upgrade files, and LUTs. DO NOT save other files, folders, or applications to your media.
- DO NOT back up your hard drive to the media card. When using a Mac, the system may ask if you want to back up your files to the media card using Time Machine; DO NOT use the media card as a backup disk.
- DO NOT delete clips off of your media card using a computer. Delete clips only by formatting your media card in-camera. For more information about formatting your media card, refer to [Secure Format](#).
- DO NOT format your media card using a computer, unless the media card cannot mount to the camera. For more information, refer to [Secure Format](#).
- When ejecting the media card from a computer, ensure that the icon has completely disappeared from the Finder window (Mac) or from Windows Explorer (Windows) before removing the media card. Sometimes, the pop-up saying that the media card has ejected displays too early.
- When the reader has a write-protect switch (such as the [CFexpress Type B Media](#) reader), it is recommended that you set the card reader to write-protect when uploading clips to prevent connected devices from adding any unwanted data to your media card.

INDEXING ON A MAC

NOTE: You can use the RED media reader with Write-Protect to prevent the Mac OS from indexing your media card.

Most newer versions of the Mac OS automatically index all external drives when you connect them. This includes when you connect media cards.

Indexing makes the connection process take longer. While the media card connects to the Mac, DO NOT remove the card. Indexing writes hidden files to the media card. When you insert an indexed media card in the camera, it can take the camera a while to recognize the hidden files and connect to the media card. While waiting for the media card to connect, DO NOT remove the card or turn off the camera. After the camera successfully connects to the media card, perform a secure format to remove the hidden files. For more information, refer to [Secure Format](#).

RED MONITOR INTERFACE CABLE

The DSMC3™ RED® Touch 7.0" LCD monitor includes a custom RED Monitor Interface (RMI) cable that provides communication between the RMI and the monitor.

Where this cable attaches to the RMI and the monitor, there are special locking features that keep the cable from accidentally detaching.

NOTE: The RMI cable is attached to the monitor at an angle, as shown in the image.

To unlock the cable locks, rotate the RMI cable lock and slide the monitor cable lock, as shown in the image:



NOTE: The USB-C-style DSMC3™ RMI cable is a custom-Pinned cable, which is not compatible with standard USB-C cable ports (including the rear camera USB-C port). The EXP ports on the RMI are for future use and are not currently supported.

Optional RED Monitor Interface (RMI) cables:

- 10" DSMC3™ RMI Cable
- 18" DSMC3™ RMI Cable
- 39" DSMC3™ RMI Cable

MONITORING

The camera provides several methods for monitoring the image. These monitoring methods include:

- Onboard LCD touchscreen
- **DSMC3™ RED® Touch 7.0" LCD**
- SDI output to a monitor
- RED Control over Wi-Fi to iOS or Android devices
- USB-C to Ethernet adapter to a computer
- 1080 M-JPEG Live Stream

ONBOARD LCD TOUCHSCREEN

The Onboard LCD touchscreen provides a live image from the camera sensor. By using the Monitoring Tools menu, you can display guides, exposure tools, focus tools, and a magnified image.

Tap on the Exposure meter to open the Monitoring tools.

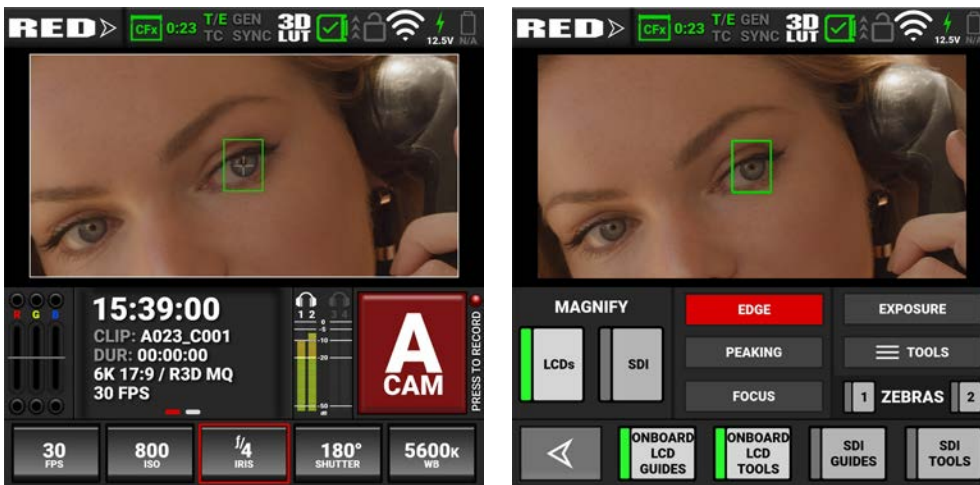

In this example the LCD magnification and LCD guides are enabled. The Autofocus rectangle is also displayed.

SDI OUTPUT TO A MONITOR

The SDI port provides a 12G SDI signal, which allows you to view the camera image on a 4K SDI monitor at up to 60 fps.

Use the Monitor menu to select the settings for SDI output, Tools, and Guides (refer to [Monitoring Menu](#))

WARNING: Under certain circumstances, it is possible for an SDI connector to incur damage when connected to an accessory and powered without using shielded cables. RED recommends only using high quality, shielded BNC cables that are rated for 12G-SDI signals and only using shielded power cables for powering SDI accessories.

Make sure power is connected to the SDI accessory at all times before you connect the BNC to the camera.

Ungrounded power from SDI accessories can damage the camera's SDI port. To avoid this possible damage, attach the power source to the accessory before attaching it to the BNC cable. When using RED Approved Third Party battery plates, unplug the BNC cable prior to hot swapping.

When possible, avoid using P-Tap (also known as D-Tap) cables to power accessories. To avoid damage when using P-Tap/D-Tap, it's imperative that the connect/disconnect sequence (below) is followed precisely.

BNC ATTACHMENT INSTRUCTIONS

When attaching SDI accessories:

1. Connect a power source to the SDI accessory; power on the SDI accessory.
2. Ensure a power source is connected to the camera. This ensures both are grounded prior to connecting the BNC. The camera's power state does not have an impact on SDI attachment sequence.
3. Connect the BNC cable to the accessory, then to the camera.

When detaching an accessory mounted to an SDI output, ensure that you remove the BNC connection to the camera before removing power to the SDI device:

1. Shutdown the SDI accessory.
2. Disconnect the BNC cable from the camera.
3. Disconnect the power source from the SDI accessory.

When you need to swap out a battery on an accessory mounted to the camera's SDI port, you must:

1. Shutdown the SDI accessory.
2. Disconnect the BNC cable from the camera.
3. Replace the battery on the SDI accessory.
4. Connect the BNC cable to the camera.
5. Power on the SDI accessory.

For more information, refer to [Preventing Damage to SDI Outputs](#).



Figure: SDI monitor with SDI Advanced Mode enabled

SDI port specifications:

- Integrated 12G-SDI with 6G-SDI, 3G-SDI, and 1.5G-SDI modes
- 12G-SDI: Up to 4096 × 2160 10-bit 4:2:2 for 60p
- 6G-SDI: Up to 4096 × 2160 10-bit 4:2:2 for 30p
- 3G-SDI: Up to 2048 × 1080 10-bit 4:2:2 for 60p
- 1.5G-SDI: Up to 2048 × 1080 10-bit 4:2:2 for 30p and 24p
- SMPTE Timecode
- HANC Metadata
- 24-bit 48 kHz Audio

You can enable or disable the image magnification, the focus and exposure tools, and the guides displayed on images sent to the SDI monitor by using the Monitoring tools (refer to [Monitoring Tools](#)).

Tap on the Exposure meter to open the Monitoring tools.

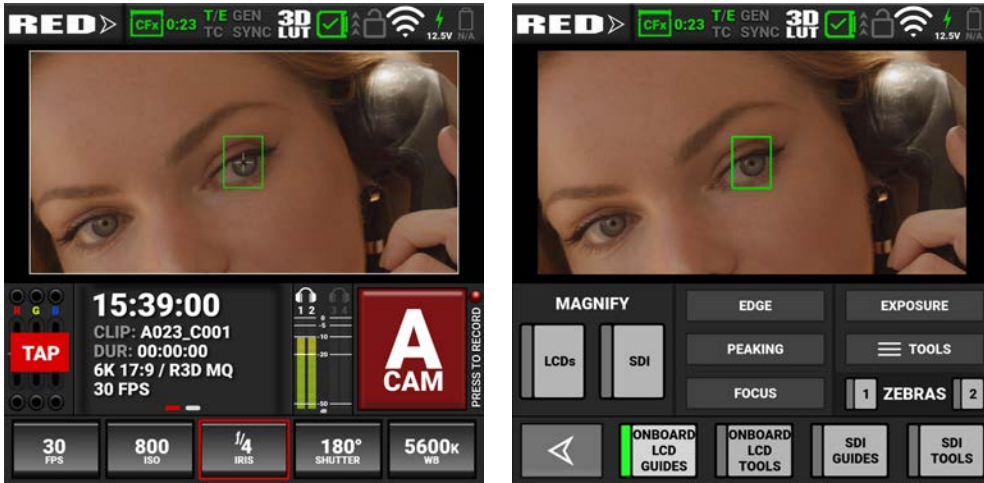

You can enable the following monitoring tools on SDI:

- Magnify
- SDI Guides (refer to [Guides](#))
- SDI Tools (refer to [Tools](#))

RED CONTROL

RED Control allows you to use Wi-Fi to connect to the camera and send monitor images to iOS and Android devices.

NOTE: You must enable live streaming under **MENU > MONITORING > LIVE STREAM** to enable the image feed.

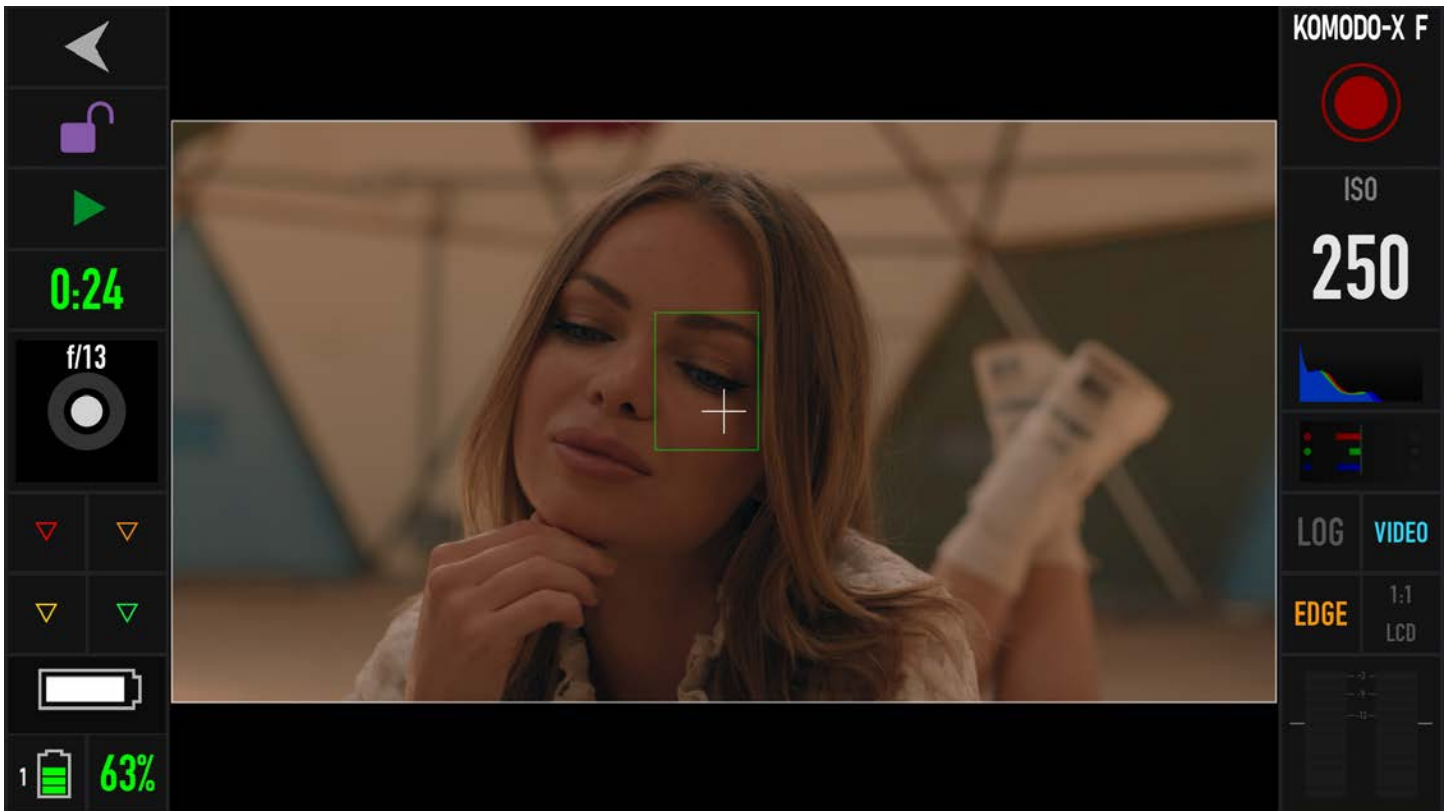

Figure: RED Control phone monitor over Wi-Fi

With the use of an Ethernet to USB-C adapter, you can also connect Ethernet devices.

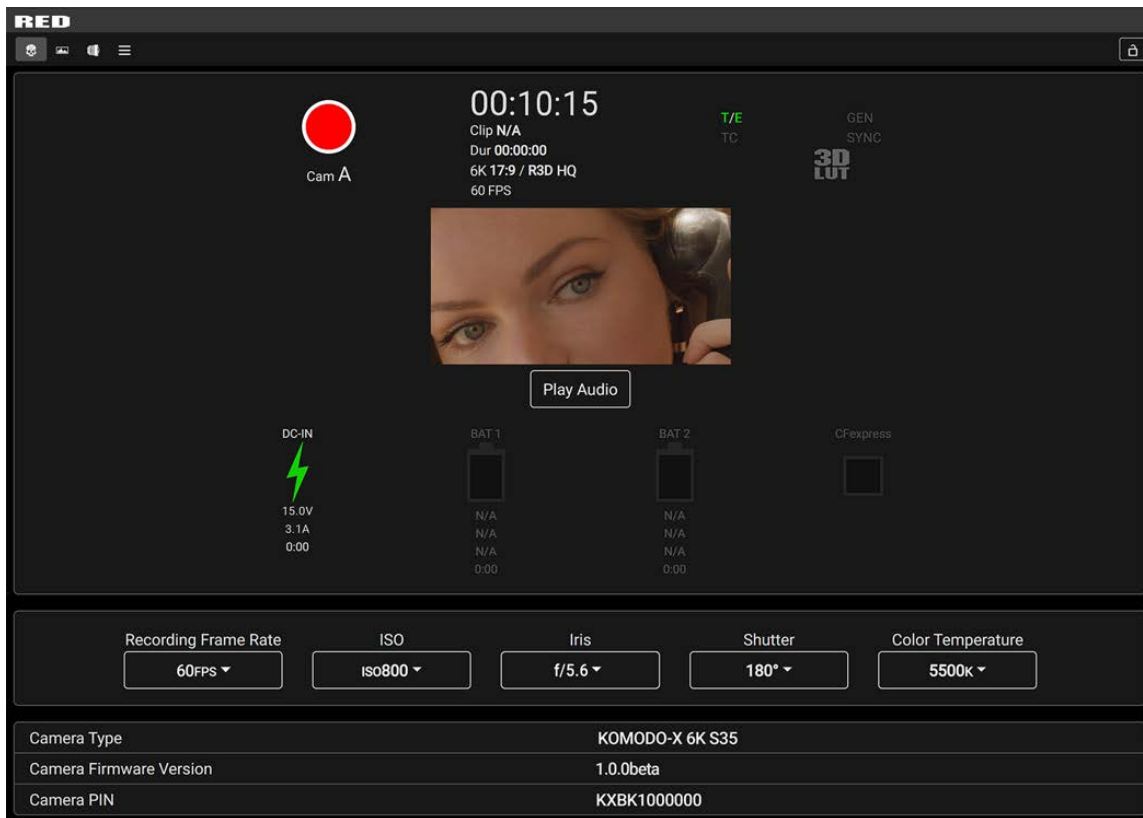

Figure: USB-C Adaptor connected to an Ethernet web browser

You can add :9090 to the end of the URL in your browser to bring up an image-only feed for remote viewing.

NOTE: You must enable live streaming under **MENU > MONITORING > LIVE STREAM** to enable the image feed.

EXPOSURE

The camera offers multiple tools to determine the current image exposure levels and provides the tools to adjust the exposure to the desired levels.

When using the R3D file format, you can correct color temperature and ISO settings at any time. The aperture and exposure time however, are two of the parameters that you cannot corrected later in R3D files.

NOTE: ProRes file format burns in ISO and White Balance, and does not allow you to adjust these settings post-recording like you can with the R3D format.

While the correct exposure is always an artistic decision, there are best practices for capturing the most dynamic range while also allowing post production to preserve the intended image information.

The goal is to reduce clipping in the bright and dark parts of the image as much as possible. Otherwise the sensor information is lost in the overexposed and underexposed areas.

The primary tool for determining the exposure levels is the histogram. It shows the exact luminance levels of the red, green, and blue pixels after you apply the ISO and White Balance settings. Monitors have their own color gamuts and brightness levels which makes the monitor less than optimal for determining the camera's exposure levels.

This camera includes a full **Histogram** and a simple RGB raw pixel exposure meter, which allows you to determine proper exposure regardless of the set ISO or camera look (for more information refer to **Onboard LCD Touchscreen**).

The full histogram provides information about how the brightness is distributed in the image. This allows you to see how close a scene is to clipping in the light and dark areas, which makes it easy to choose aperture, exposure, and ND filters solutions accordingly.

Example of overexposure with histogram and exposure meter:



Example of underexposure with histogram and exposure meter:



Example of a balanced exposure with histogram and exposure meter:



FALSE COLOR EXPOSURE TOOLS

While the histogram provides information about the brightness distribution and clipping of the image, it does not show you the areas in the image that are near, or that have reached, clipping. For this, the camera provides image overlays that provide false colors to indicate precise exposure levels.

FALSE COLOR EXPOSURE MODE

The False Color Exposure mode overlay provides information where the image is close to clipping or already clipping in the highlights (red), midtones (green), and shadows (purple). For more information, refer to [False Color Exposure Mode](#).

Example of Exposure Mode:



FALSE COLOR VIDEO MODE

The False Color Video mode provides more gradual information about the brightness in different parts of the image. This is helpful when you want to expose skin color at the right level, while ignoring the fact that backgrounds might be overexposed or underexposed (refer to [False Color Video Mode](#)).

Example of Video Mode:



FALSE COLOR GIO SCOPE MODE

Gio Scope mode displays a color overlay on top of a desaturated RAW sensor image, identifying 16 increments within the dynamic range of the sensor. The RGB settings (color temperature, ISO, LUT, etc.) are not used by this mode.

Each number (1 to 16) indicates a different increment of dynamic range. Number 16 represents the top increment, and is broken up into 1/8th sub-increments to show highlight roll-off. Each 1/8th increment is represented by a different shade of red, ranging from light red (less light) to dark red (most light, clipping).

FOCUS

Focus, like **Exposure** and **Recording Frame Rate** is a property that cannot be fixed easily in post-production. To make sure the camera is focused correctly when you begin recording, it is important to rely on focus tools that do not rely on the visibility on the LCD Touchscreen or a monitor.

The camera interface includes the focus tools you can use to reach the desired image focus (refer to **Peaking**).

FOCUS PEAKING MODE

The Focus Peaking mode applies a sharpening filter to the image that emphasizes edges of the subject in focus.

Example of Focus Peaking:



EDGE PEAKING MODE

The Edge Peaking mode hides the image and only shows the edges. This provides the best visual representation of the subject that is currently in focus.

Example of Edge Peaking mode:



PEAKING PEAKING MODE

The Peaking Peaking mode emphasizes the edges, and it also highlights them by using a selectable color.

Example of Peaking Peaking mode:



TIMECODE

Timecode provides a mechanism to reference frames from the camera's recorded clips to other devices like cameras and audio recorders. Some devices can also gather other data like lens metadata or camera orientation that is referenced by Timecode to merge the data back together in post-processing.

KOMODO provides two separate Timecode concepts: Time of Day (TOD) and Edgecode. Both TOD and Edgecode are stored in the R3D file. The user can select which Timecode displays on the **Onboard LCD Touchscreen** by setting the preference in **Timecode Display Mode**.

TIME OF DAY

TOD Timecode reflects the time and date the camera recorded each frame. KOMODO synchronizes the TOD Timecode to an external Timecode generator (when one is connected to the **Extension Port**) or synchronizes to the internal real-time clock of the camera.

SETTING UP TOD TIMECODE

To set up TOD Timecode on the camera, perform the following:

1. Open the Audio / Timecode menu: **MENU > AUDIO / TC**:

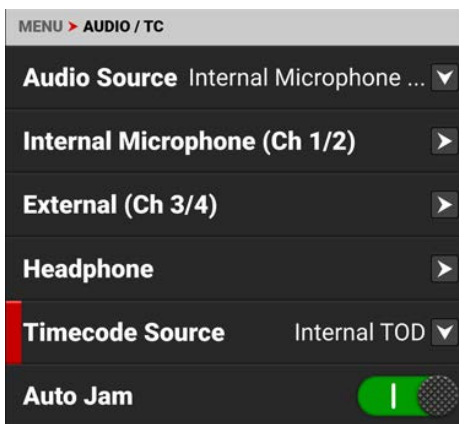

2. Select Timecode Source. The Timecode Source menu opens:

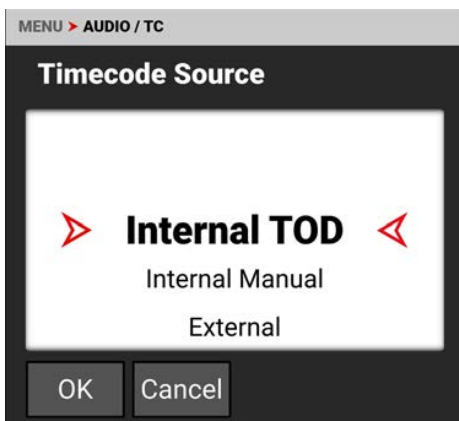

3. Select Internal TOD to use the camera's internal real time clock, select Internal Manual to specify a starting time for the internal clock, or select External to use an external Timecode generator connected to the **Extension Port**.

4. When you select Internal TOD, you can use the **Auto Jam** switch to enable the camera to automatically synchronize the Timecode to the camera's internal clock.

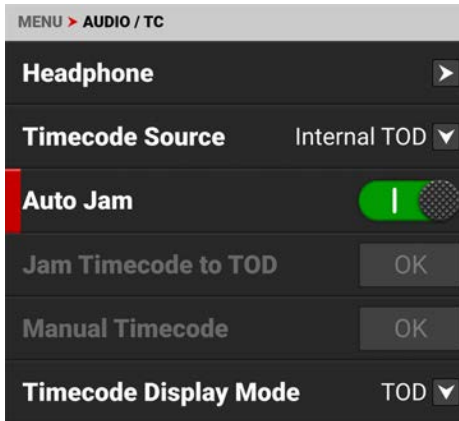

The camera displays the Timecode on the **Onboard LCD Touchscreen**



NOTE: The timecode is reset when the camera is turned off, unless an external power source remains connected and powered.

EDGECODE

Edgecode only advances while the camera is recording frames. Each frame is sequential. When the media is replaced, the new media starts the timer over. You can set the Edgecode timer manually by using the **Secure Format** menu.

SETTING UP EDGECODE TIMECODE

To set up Edgecode Timecode on the camera, perform the following:

1. Open the Audio / Timecode menu: **MENU > AUDIO / TC**:

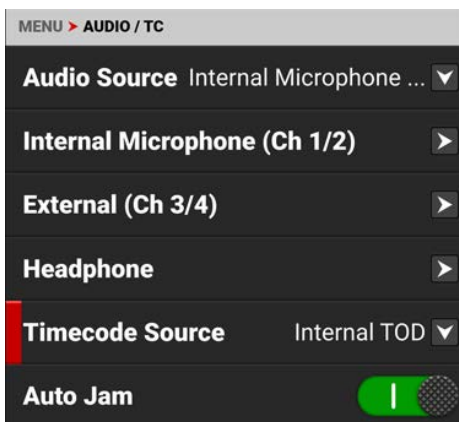

2. Swipe the touchscreen up to scroll down to Timecode Display Mode:

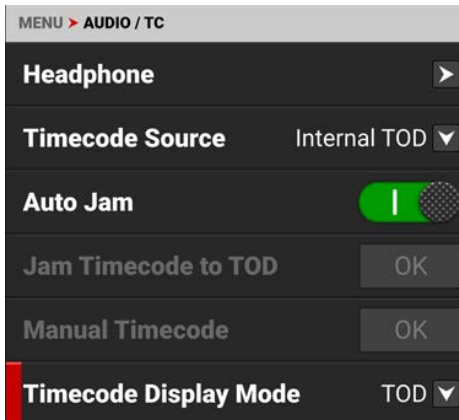

3. Select Timecode Display Mode. The Timecode Display Mode menu opens:

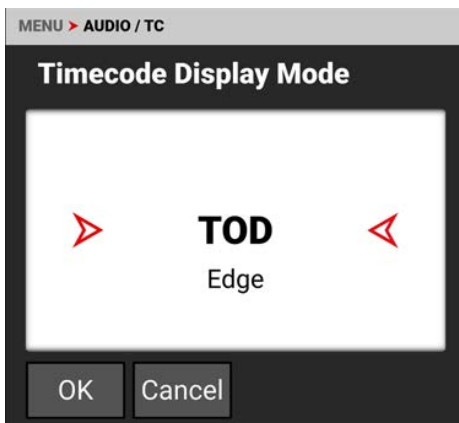

4. Select Edge and tap OK to use Edgecode. The camera displays the Edgecode on the **Onboard LCD Touchscreen**



ZEBRA MODES

Use Zebra mode to enable and adjust the upper and lower values for two (2) independent zebra indicators. Use Zebra 1 for highlight exposure, and use Zebra 2 for mid-tones or shadows. Zebras are disabled by default.

For more information, refer to the [Exposure with RED Cameras: False Color and Zebra Tools](http://www.red.com/red-101/exposure-false-color-zebra-tools) article, available at www.red.com/red-101/exposure-false-color-zebra-tools.

ENABLING THE ZEBRA 1 INDICATOR

1. Go to **MENU > MONITORING > TOOLS** and select **ZEBRA 1**.
2. Set a Low IRE of 98.
3. Set a High IRE of 100.

Areas of the image exposed within the IRE range are indicated by red diagonal lines at -45° .

The default settings are Low IRE = 98 and High IRE = 100.

ENABLING THE ZEBRA 2 INDICATOR

1. Go to **MENU > MONITORING > TOOLS** and select **ZEBRA 2**.
2. Set a Low IRE of 41.
3. Set a High IRE of 48.

Areas of the image exposed within the IRE range are indicated by green diagonal lines at 45° .

The default settings are Low IRE = 41 and High IRE = 48.

ZEBRA OVERVIEW

Zebra is a specialty mode that is capable of showing up to two customized overlays with arbitrary IRE ranges. Unlike the other two modes, Zebra indicators appear as diagonal stripes, they are fully configurable, and they have the advantage of preserving a full-color base image.

With traditional video cameras, many used a single zebra to indicate highlight detail. It would often be set at 70% (70 IRE), in part because this is where a white piece of paper would begin to have minimal texture when rendered using a typical contrast curve. Skin tones or skies would be exposed to appear just darker or brighter than these lines. If enabled, a second zebra would typically indicate either mid-tones or shadows. For deep shadows, you can set the second indicator to below 10% intensity or 10 IRE, and set the first indicator to highlights above 85 IRE.

However, as with other IRE-based modes, Zebra mode is only applicable for the current ISO settings (such as with SDI output), not for the raw image data. If anything is changed in post-production, the indicators won't be representative of the final output tones. In those situations, Zebra mode is more of a preview and output brightness tool than an exposure tool.

PRE-RECORDING CONTENT

This section explains how to use the Pre-Record feature.

To start pre-recording, press the **Record** button.

The LCD changes from the Ready appearance to the Pre-Record appearance:



Press the **Record** button again to start recording.

When you start recording, the appearance of the LCD changes from the Pre-Record appearance to the Record appearance:



The camera adds the Pre-Record clip to the beginning of your recording.

You can touch and hold the record button on the Onboard LCD to stop Pre-Record. You can also assign physical buttons on the camera to Pre-Record Stop to stop and erase the current Pre-Record segment, or Pre-Record Toggle to completely disable or enable the Pre-Record function.

For information about enabling and configuring Pre-Record, refer to [Pre-Record](#).

CALIBRATING THE SENSOR

Sensor calibration is a process during which the camera optimizes image quality by ensuring that pixel sensitivity remains consistent throughout the sensor.

WHEN TO CALIBRATE THE SENSOR

Calibration is recommended:

- When shooting in an environment where the temperature is significantly different (+/- 30° F...) from the current calibration. The T in the T/E Status Bar indicator will turn yellow (refer to [Status Bar](#) for more information)
- After an extreme change in exposure time (+/- 1/2 sec). The E in the T/E Status Bar indicator will turn yellow (refer to [Status Bar](#) for more information)
- After each firmware upgrade
- When you have any image quality concerns

UPGRADING THE FIRMWARE

You can receive the best performance from your camera by installing the latest firmware. Make a habit of frequently visiting RED Downloads at www.red.com/downloads to check for new versions of camera firmware, updated operation guides, and post-production software.

VERIFYING THE FIRMWARE VERSION

To view the firmware version that is currently installed on your camera, open **Menu > System Settings > System Status > Camera Info**:

... > SYSTEM STATUS > CAMERA INFO	
Camera Type	KOMODO-X 6K S35
Camera PIN	KXBK1000000
Version	1.1.0beta
Runtime	4.3 Hours

Version displays the currently installed camera firmware. A higher number reflects a newer release.

UPGRADING THE FIRMWARE

Install the most recent firmware. Unless otherwise specified in the release notes, you do not need to upgrade to any firmware in between your current version and the most recent version available online.

You can upgrade the firmware by using an upgrade folder copied to a media card, or you can upgrade over an Ethernet connection.

NOTE: You must calibrate the sensor after upgrading the camera. For more information, refer to [Calibrating the Sensor](#).

UPGRADING FROM A MEDIA CARD

1. Download the most recent firmware for your camera from RED Downloads at www.red.com/downloads.
2. Unzip the firmware zip file.
3. In the unzipped folder, navigate to the **upgrade** folder.
4. Copy the **upgrade** folder and its contents to the root level of the media card directory.
5. Unmount the media card from your computer and remove the media card from the media reader.
6. Insert the media card in the camera. The camera detects the upgrade folder and prompts you to upgrade the firmware.
7. From the camera UI, navigate to **Menu > Maintenance**.

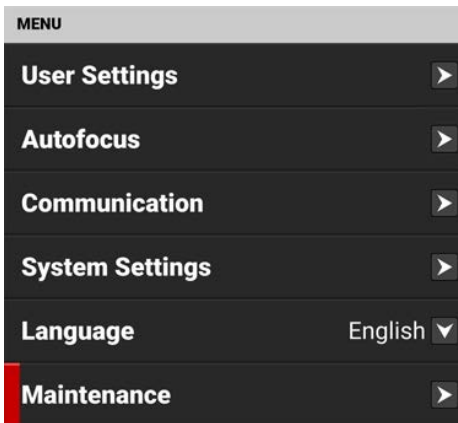

8. From the Maintenance menu, navigate down to Upgrade and tap OK.

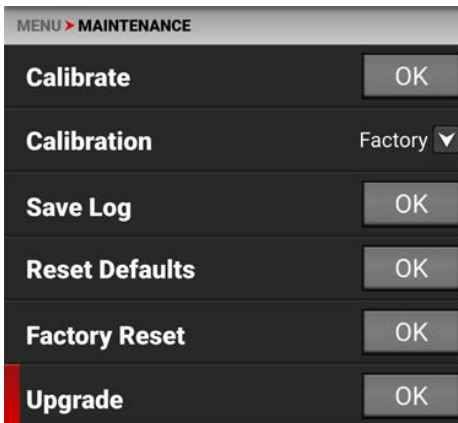

The Firmware Upgrade confirmation screen displays:



9. Tap **Upgrade** to confirm. The Firmware Upgrade progress screen displays:

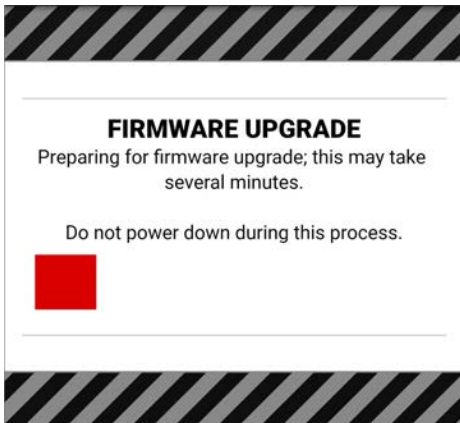

During the upgrade, the fans run at high speed and the following occurs:

- The camera displays the **SHUTTING DOWN** screen and reboots
- The camera restarts and displays the **UPGRADING** screen
- The camera displays the **INITIALIZING** screen
- The camera displays the **FIRMWARE UPGRADE** progress screen:



The Firmware Upgrade success message screen displays with a **RESTART** button:

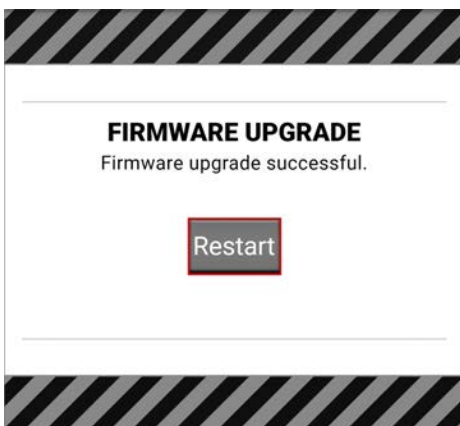

10. Tap **Restart**. The camera displays the **SHUTTING DOWN** screen and reboots again.

11. The camera restarts displaying the Start screen, the **INITIALIZING** screen, and then the Software License Agreement (SLA) displays:

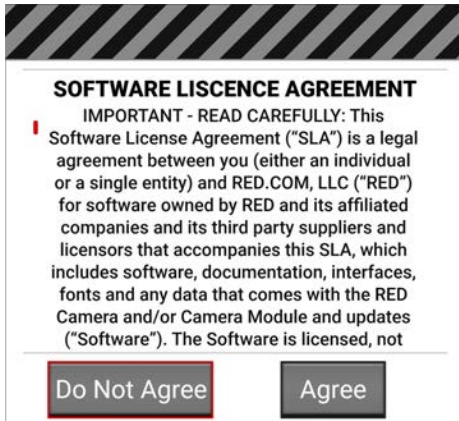

12. Tap **Agree**. If you do not agree to the SLA, the camera cannot be used. The SLA continues to display until it is accepted.
13. Recalibrate the camera before recording. Refer to the **Calibration** section and **Calibrating the Sensor** for more information.

UPGRADING THE DSMC3™ RED® TOUCH 7.0" LCD FIRMWARE

You can receive the best performance from your DSMC3™ RED® Touch 7.0" LCD monitor by installing the latest firmware. Make a habit of frequently visiting RED Downloads at www.red.com/downloads to check for new versions of DSMC3™ RED® Touch 7.0" LCD firmware, updated operation guides, and post-production software.

UPDATING AUTOMATICALLY THROUGH THE CAMERA

When a newer firmware is detected on the camera, the DSMC3™ RED® Touch 7.0" LCD will prompt you on each boot to update the monitor. Follow the on-screen prompts to update the monitor.

UPDATING MANUALLY THROUGH SmallHD

When a newer monitor firmware is available directly from SmallHD, there are two ways you can upgrade the DSMC3™ RED® Touch 7.0" LCD firmware.

UPGRADE DIRECTLY FROM THE DSMC3™ RED® TOUCH 7.0" LCD

1. Download the DSMC3™ RED® Touch 7.0" LCD upgrade .bin file directly from downloads.smallhd.com, to the root directory of a 2, 4, 8, or 16 GB SD card.
2. Insert the SD card in the monitor.
3. From the DSMC3™ RED® Touch 7.0" LCD Settings Panel, initiate the update.

UPGRADE THROUGH THE CAMERA

1. Download the DSMC3™ RED® Touch 7.0" LCD upgrade .bin file directly from downloads.smallhd.com.
2. Create a folder named "smallhd" on the root of the camera's media card.
3. Copy the firmware file to the "smallhd" folder.
4. Insert the card in the camera, and initiate the update through the Settings Panel of the DSMC3™ RED® Touch 7.0" LCD.

NOTE: This method requires that the monitor be on at least firmware version 5.0.0 to work. If the monitor is on OS4, use the *Directly from the DSMC3™ RED® Touch 7.0" LCD* firmware upgrade method.

SYSTEM MAINTENANCE

All RED products are designed for rugged durability, but precision instruments demand proper care. Follow the instructions in this section to clean, maintain, and store your devices.

WARNING: DO NOT rinse or immerse the camera or other accessories in water. Keep dry at all times.

WARNING: DO NOT use soaps, detergents, ammonia, acetone, alkaline cleaners, abrasive cleaning compounds, or solvents. These substances may damage lens coatings and electronic circuitry.

WARNING: DO NOT use an excess of cleaning solution.

WARNING: DO NOT reuse swabs or wipes.

WARNING: DO NOT attempt to clean the sensor or optical cavity for any reason. If the sensor becomes dirty, submit a Support ticket at <https://support.red.com>.

WARNING: DO NOT attempt to modify, dismantle, or open the camera, lens, or other accessory as doing so may expose you to electric shock and serious injury. There are no user-serviceable parts inside. Alteration or repairs made to the camera or accessories, except by a RED authorized service facility, voids all warranties.

WARNING: Use caution with compressed air and gas dusters, since the high pressure, oily residue, cold air, particulates, and moisture may cause damage. You may use a filtered, non-residue gas duster to clean non-critical areas, such as around the fans and other recesses on the exterior of the camera. Damage to the camera or other components of the camera system caused by using compressed air or gas dusters is not covered under warranty.

WARNING: DO NOT use compressed air and gas dusters on the sensor or on any optics.

WARNING: DO NOT use compressed air and gas dusters on or around the integrated microphones on the front of the camera.

EXTERIOR SURFACES

Use a filtered, non-residue gas duster to clean non-critical areas, such as around the fans and other recesses on the exterior of the camera.

Clean with a dry lint-free cloth. When cleaning your camera and accessories, remember that the devices are not waterproof and moisture can damage electronic circuitry.

STORAGE

WARNING: DO NOT store the camera or accessories in any place with extreme temperatures, direct sunlight, high humidity, severe vibration, or strong magnetic fields.

ONBOARD LCD SCREEN

This section explains how to clean the Onboard LCD screen.

APPROVED LCD SCREEN CLEANERS

Use only the following products to clean the Onboard LCD screen:

- Ionized rubber air bulb
- Delkin Devices Sensor Solution[®]
- Lens swabs
- Dry optical wipes

NOTE: Before cleaning the screen with swabs or wipes and a cleaning solution, ALWAYS use an ionized rubber air bulb to remove any solid particles. Cleaning the screen without removing solid particles increases the risk of scratching the screen.

PROHIBITED LCD SCREEN CLEANERS

DO NOT use any of the items listed below to clean the Onboard LCD screen. These products have not been tested on RED products and may cause damage or streaking.

- Windex
- Solvents
- Gas dusters
- Compressed air
- Rubbing alcohol
- Isopropyl alcohol
- Third-party cleaning kits
- Pancro Professional Lens Cleaner (or equivalent)
- Pre-packaged lens cleaner containing any additives, such as detergent, anti-static compounds, or fragrance.

WARNING: Damage to the Onboard LCD screen or other components of the camera system caused by using prohibited cleaners is not covered under warranty.

WATER DAMAGE

If your device has come in contact with water or you suspect water damage, submit a Support ticket at <https://support.red.com> immediately.

WARNING: DO NOT attempt to power any device that may have water damage.

WARNING: DO NOT place the device in a container of rice, silica gel, or desiccant packets in an attempt to dry the device.

6. TROUBLESHOOTING

GENERAL TROUBLESHOOTING TIPS

This section describes general troubleshooting tips:

1. Confirm the Firmware version currently installed on your camera. Each firmware release contains bug fixes and other improvements. You may be experiencing a bug resolved in a later release.
 - You can find this under **Menu>System Settings>System Status>Camera Info**.
 - To confirm and download the latest firmware version, visit red.com/downloads.
 - If your current firmware is out-of-date, please upgrade to the latest release build found on red.com/downloads.
2. Reboot the camera by powering it off and back on.
3. Test the camera by installing an alternate or recently formatted media card.
4. Ensure that all of the cables and connections are fully seated and locked in place (if applicable).
5. Remove all attached accessories, RED and third-party. Ensure all contacts are clean, undamaged, and free of debris before remounting. Try booting the camera using the AC power adaptor without any accessories attached to determine whether the issue persists before reattaching any accessories.
6. Try rebooting the camera again after reattaching the accessories. If the camera boots without accessories and the symptom reoccurs after reattaching, try adding the accessories one at a time to isolate the root cause. This helps narrow down root causes to specific accessories and helps to ensure that a bad connection is not the source of the issues.
7. Perform a Reset Defaults. This will restore all camera settings back to factory default settings and reduce the possibility that applied settings caused the issue.

You can find this under **Menu>Maintenance>Reset Defaults**.

8. As a last resort, perform a Hard Restore. This will restore all camera settings back to factory default settings but goes a step further to clear camera internal memory.
 - a. Remove all attached accessories, RED and third-party, leaving only an AC power adaptor attached.
 - b. Turn the camera off.
 - c. Press and hold the REC button and at the same time switch the power ON.
 - d. Continue to hold the REC button until the camera finishes booting and the license agreement displays.

This completes the hard restore.



CONTACT SUPPORT

















If your camera continues to misbehave after you have performed these troubleshooting steps, submit a request for Technical Support. Include the following with the request:

- A detailed description of the issue and events that led up to its occurrence, including steps to replicate.
- A description of the rate of occurrence confirming whether the symptom is rare, intermittent, or continuous.
- A freshly saved camera Log File. The Log File can be saved through **Menu>Maintenance>Save Log**. Refer to [Save Log](#) for more information.
- Please confirm the firmware version currently installed. You can find the firmware version number under **Menu>System Settings>System Status>Camera Info**.
- A short video detailing the issue that is occurring, showing your camera setup and all attached accessories.
- A detailed list of accessories (RED and third-party), lens, and modules attached at the time the issue occurred.
- A description of how the camera and attached accessories were powered when the issue first occurred.

STATUS ICONS

The following is a table of the camera's status icons.

ICON	DESCRIPTION
	The CFexpress Type B media card is good ( and recording time remaining)
	The media card is missing
	The media card is incompatible
	The sensor temperature (T) and exposure (E) calibration are good
	The sensor temperature (T) requires calibration
	The sensor exposure (E) requires calibration
	Gray indicates that no Timecode generator signal is detected
	Green indicates that the Timecode source is connected and jammed
	Red indicates that the Timecode source is connected and not jammed
	White indicates that the Timecode source is jammed and not connected
	Yellow indicates that the Timecode source is cross-jammed (at a different Project Time Base)
	Gray indicates that no Genlock signal is detected
	Green indicates that the camera is receiving and is locked to a Genlock signal
	Red indicates that the camera is receiving and is not locked to a Genlock signal
	Gray indicates that no synchronization is detected
	Green indicates that the camera's sensor is synchronized with Timecode and that the camera's output is synchronized with a Genlock signal
	Yellow indicates that the camera's sensor is NOT synchronized with Timecode and that the camera's output is synchronized with a single camera or a Genlock signal
	Gray indicates that no 3D LUTs are in use
	White indicates that the camera is using a 3D LUT
	Camera temperature is good
	Camera overheating warning
	Camera overheating

ICON	DESCRIPTION
	Camera shutting down
	Gray indicates no FTPS data is transferring
	Green arrows indicate FTPS data is transferring
	Gray and open indicates that the camera LCD is unlocked
	White and closed indicates that the camera LCD is locked
	Gray and empty indicates that no Wi-Fi signal is detected
	White bars indicate the strength of the Wi-Fi signal detected (Infrastructure)
	White antenna indicates that Wi-Fi signal is broadcasting (Ad-hoc)
	Gray indicates that no DC power is connected
	Green indicates that the camera is receiving DC power
	Gray indicates that no battery is connected
	White indicates that the battery is connected and green shows the relative level of charge remaining
	Yellow indicates 10 minutes of power remaining
	Red indicates less than 5 minutes of power remaining
	Gray question mark indicates no communication with the battery and no power
	White question mark indicates no communication with the battery and power
	Gray exclamation point indicates error communicating with the battery and no power

A. MECHANICAL DRAWINGS

NOTE: Dimensions are shown in mm.

FRONT VIEW

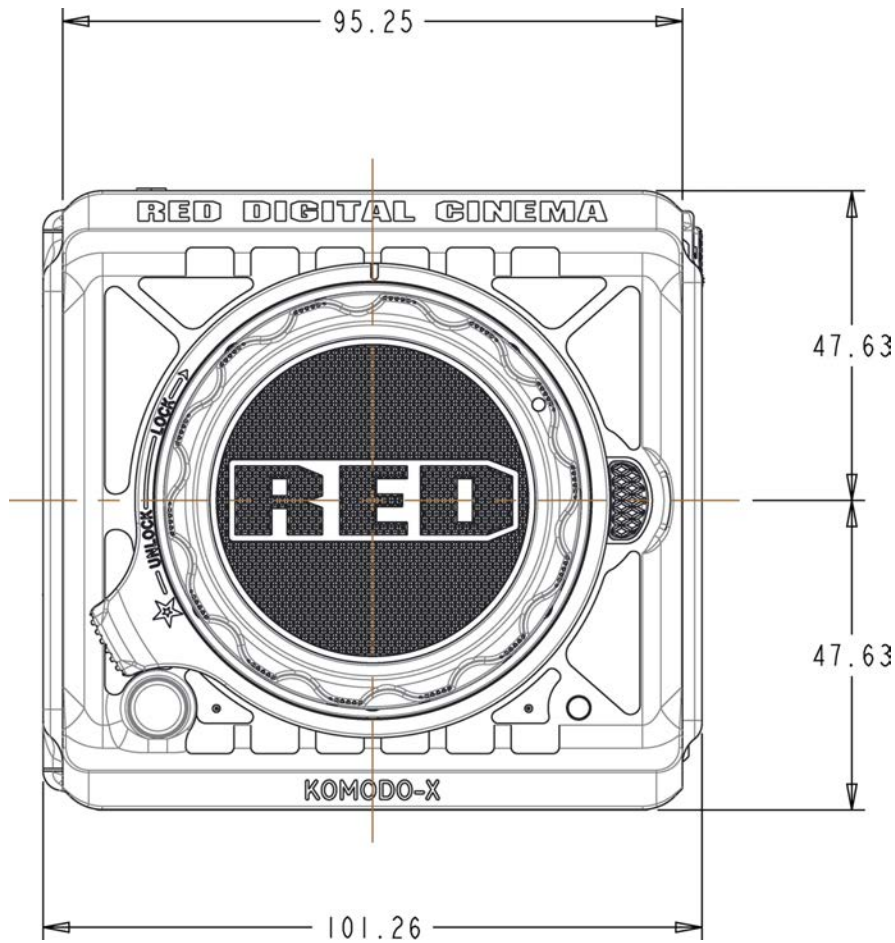

Figure: Camera Front View

BACK VIEW

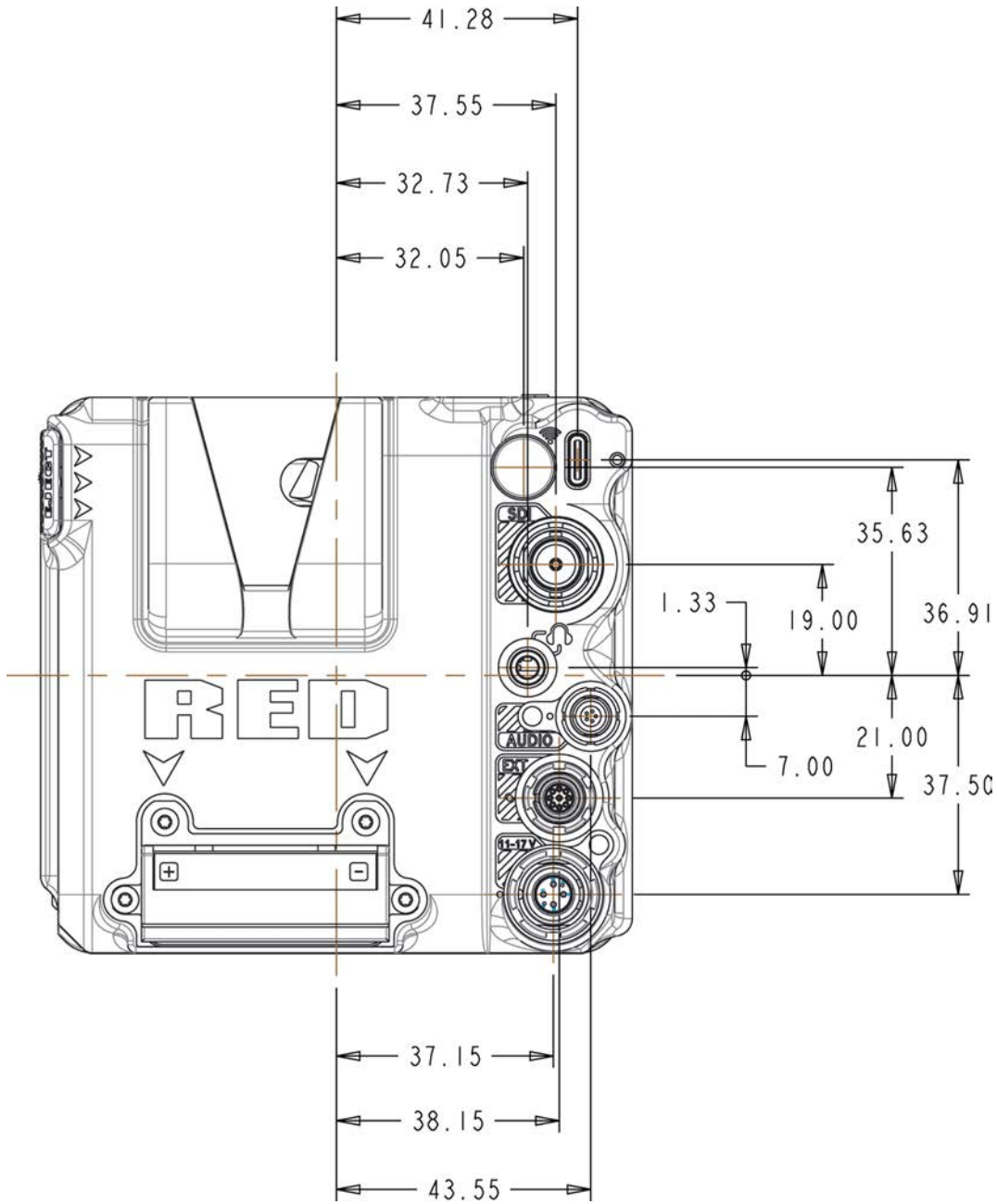

Figure: Camera Back View

RIGHT SIDE VIEW

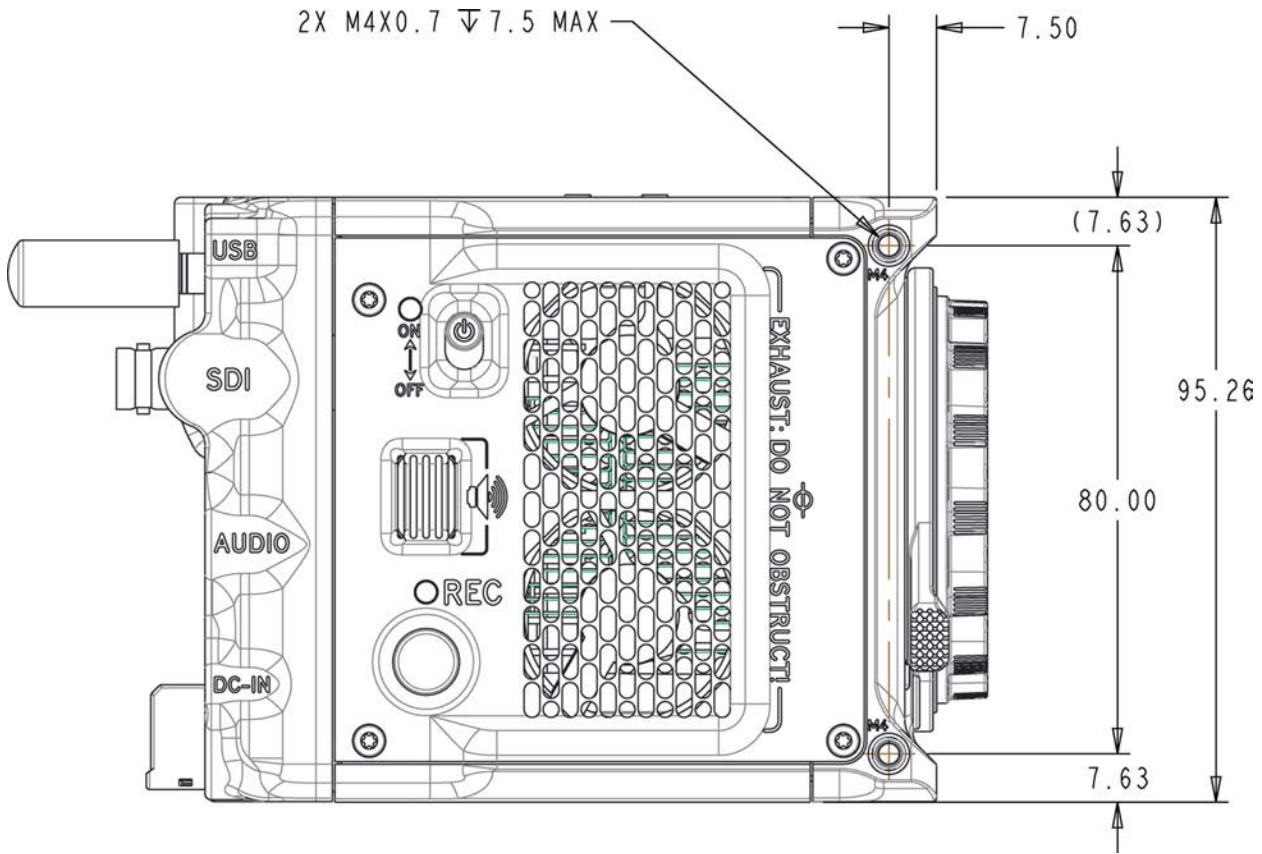

Figure: Camera Side View (Right)

LEFT SIDE VIEW

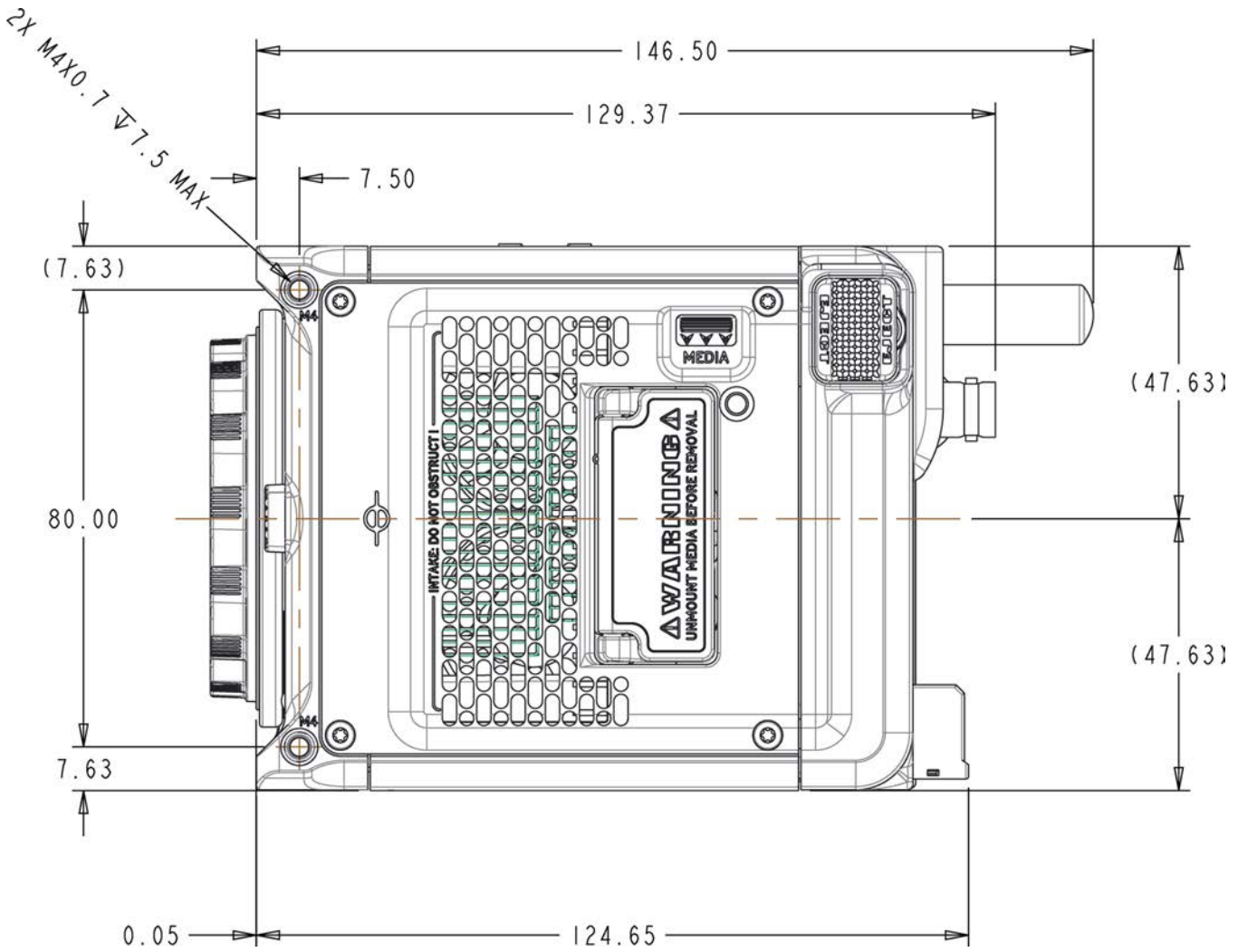

Figure: Camera Side View (Left)

BOTTOM VIEW

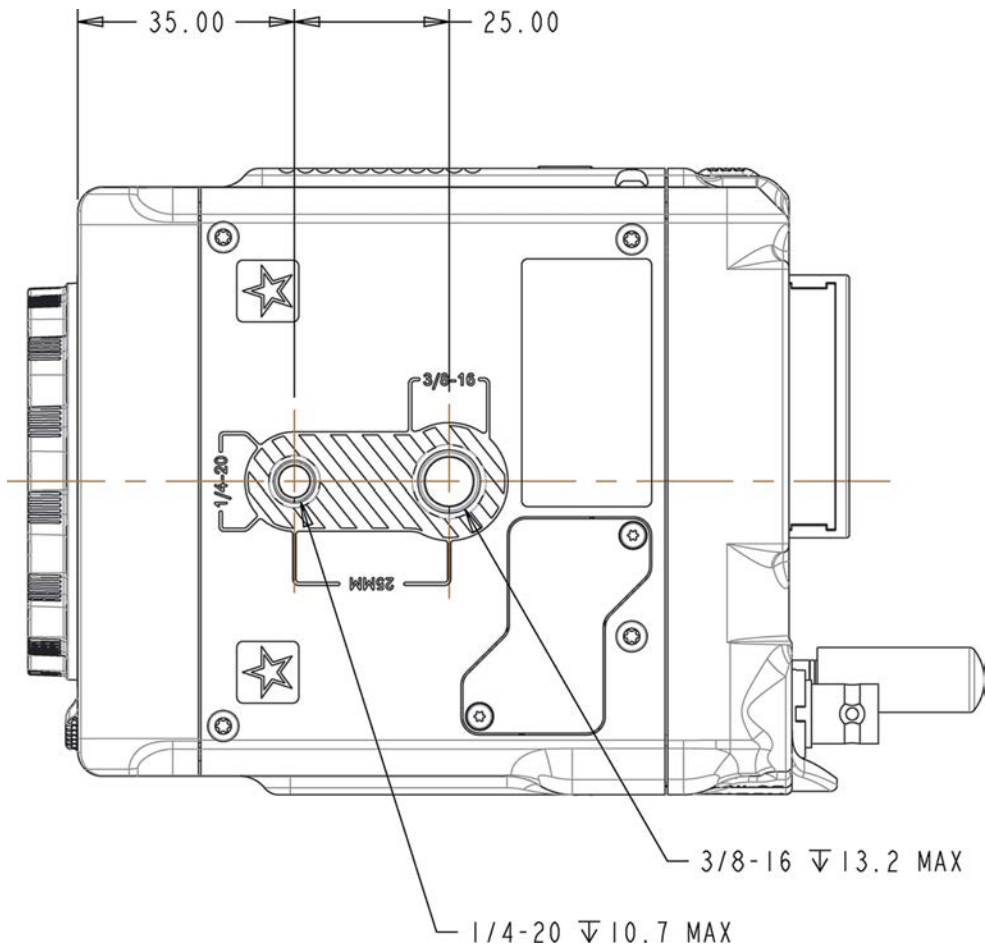

Figure: Camera Bottom View

FEMALE RP SMA PORT

The female RP SMA connector provides an attachment for the male RP SMA Wi-Fi antenna.



Figure: Front face of the female RP SMA port (looking at the back of the camera).

NOTE: Mating connector is a Wi-Fi antenna with a standard male RP SMA connector.

USB TYPE-C PORT



The USB Type-C port is used primarily for data connections. The USB Type-C port provides 5 volts at 0.5 amps.

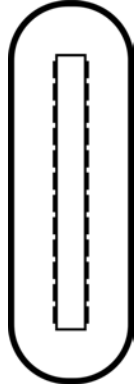

Figure: Front face of the USB-C port (looking at the back of the camera).

NOTE: Mating connector is a standard USB-C male connector.

12G-SDI



The 12G-SDI male 75-ohm BNC port deliver 12, 6, 3, or 1.5 Gbps of image bandwidth ideal for the 4Kp60 format. Other features include:

- Up to Four (4) channels of embedded audio
- Time of Day and Edge Timecode
- Record Tally flag
- Clip name information (as SMPTE RP-188 VITC2 HANC metadata)

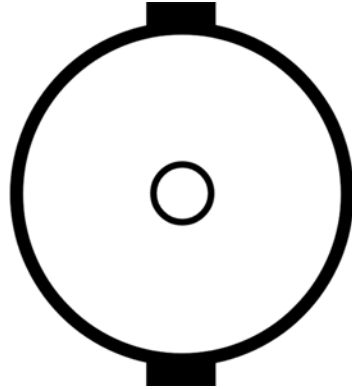

Figure: Front face of the 12G-SDI male BNC connector (looking at the back of the camera).

12G-SDI 75-OHM MALE BNC CONNECTOR

PIN	SIGNAL	DESCRIPTION	DIRECTION
Center	12/6/3/1.5 G-SDI Signal	Up to 4096 x 2160: 422 for 60p - Log view or LUT view (SMPTE ST 2082)	Out
Shell	Ground	Common ground (camera ground)	N/A

NOTE: Mating connector is standard 75-ohm female BNC connector rated for 12G-SDI.

WARNING: Under certain circumstances, it is possible for an SDI connector to incur damage when connected to an accessory and powered without using shielded cables. RED recommends only using high quality, shielded BNC cables that are rated for 12G-SDI signals and only using shielded power cables for powering SDI accessories.

Make sure power is connected to the SDI accessory at all times before you connect the BNC to the camera. Ungrounded power from SDI accessories can damage the camera’s SDI port. To avoid this possible damage, attach the power source to the accessory before attaching it to the BNC cable. When using RED Approved Third Party battery plates, unplug the BNC cable prior to hot swapping.

When possible, avoid using P-Tap (also known as D-Tap) cables to power accessories. To avoid damage when using P-Tap/D-Tap, it’s imperative that the connect/disconnect sequence (below) is followed precisely.

BNC ATTACHMENT INSTRUCTIONS

When attaching SDI accessories:

1. Connect a power source to the SDI accessory; power on the SDI accessory.
2. Ensure a power source is connected to the camera. This ensures both are grounded prior to connecting the BNC. The camera's power state does not have an impact on SDI attachment sequence.
3. Connect the BNC cable to the accessory, then to the camera.

When detaching an accessory mounted to an SDI output, ensure that you remove the BNC connection to the camera before removing power to the SDI device:

1. Shutdown the SDI accessory.
2. Disconnect the BNC cable from the camera.
3. Disconnect the power source from the SDI accessory.

When you need to swap out a battery on an accessory mounted to the camera's SDI port, you must:

1. Shutdown the SDI accessory.
2. Disconnect the BNC cable from the camera.
3. Replace the battery on the SDI accessory.
4. Connect the BNC cable to the camera.
5. Power on the SDI accessory.

For more information, refer to [Preventing Damage to SDI Outputs](#).

HEADPHONE JACK



The female stereo 3.5 mm headphone port provides an attachment for stereo headphones.

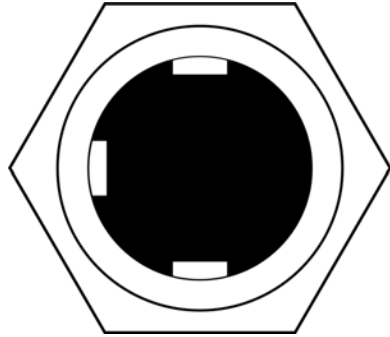

NOTE: Only use headphones with a 3-conductor jack. If you try to use a headset with a mic and 4-conductor jack, it will produce unpredictable results.

Figure: Front face of the female 3.5 mm headphone port (looking at the back of the camera).

NOTE: Mating connector is a 3.5 mm stereo headphone plug.

AUDIO PORT



The female LEMO 5-Pin 00B audio connector accepts 2-channel audio, Line, Mic, and +48V Phantom Power.

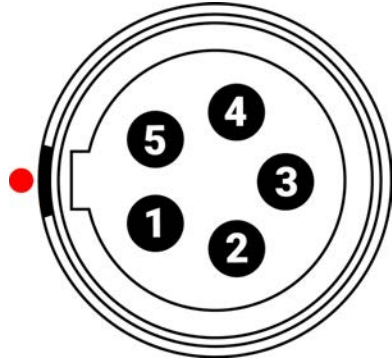

Figure: Front face of the female 5-Pin 00B audio connector (looking at the back of the camera).

LEMO 5-PIN 00B FEMALE AUDIO CONNECTOR

PIN	SIGNAL	DESCRIPTION
1	Ground	Ground to camera
2	Ch 3 +	Channel 3 signal (positive)
3	Ch 3 -	Channel 3 negative
4	Ch 4 +	Channel 4 signal (positive)
5	Ch 4 -	Channel 4 negative

NOTE: Mating connectors are FGG.00.305.CLAD35Z (5-Pin 00 circular push-pull connector, straight plug) and FHG.00.305.CLAD35Z (5-Pin 00 circular push-pull connector, right-angle plug).

Accessories:

- DSMC3™ RED® 5-Pin to Single 3.5 mm Adapter
- DSMC3™ RED® 5-Pin to Dual XLR Adapter

EXTENSION PORT



The female 9-contact 0B ODU Extension port supports serial (RS-232 RX and TX), a General Purpose Input (GPI) trigger (active-low switch closure), General Purpose Output (GPO), Timecode, and Genlock. The connector also offers auxiliary 5-Volt power out, with a maximum sustained current draw of 500 mA.

To operate the GPI contact closure style trigger, short Pin 6 (GPI) to Pin 9 (ground).

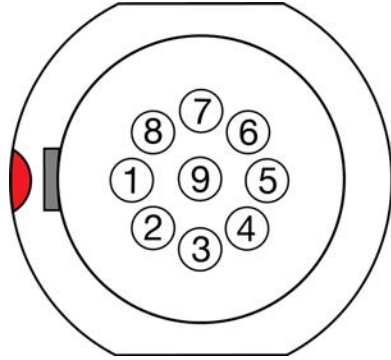

Figure: Front face of the female 9-contact Extension port (looking at the back of the camera).

NOTE: The required mating connector is 9-Pin 0L Straight Plug Connector (ODU, part# SX0L0X-P09MCC0-0001).

9-PIN 0B ODU EXTENSION PORT PINOUT

PIN	SIGNAL	DETAILS
1	5 V AUX	5 Volt AUX (500 mA Max) enabled using the Power menu
2	Timecode Out	Timecode Out – SMPTE 12M ¹
3	GPO	General Purpose Out: Recording Indicator Out, Sensor Sync Out using 3.3 volt logic level
4	UART TX	Serial RS-232 transmit (refer to the Serial menu)
5	UART RX	Serial RS-232 receive (refer to the Serial menu)
6	GPI	General Purpose In, 3.3-Volt logic level ²
7	Timecode In	Timecode In – SMPTE 12M
8	Genlock	Tri-Level Genlock In (SMPTE 296M and 274M)
9	GND	Signal and power ground

1. Not currently supported.

2. The signal path includes a resistor pulling the signal high, which is designed to work with a closure switch connected to GND.

COMPATIBLE CABLES

- **790-0685:** RED 9-Pin EXT to Flying Lead 1.3'
- **790-0674:** RED EXT to Timecode 3'

6-PIN DC-IN



The male 6-Pin 1B DC-IN connector accepts DC input power from 11 V DC to 17 V DC. A built-in power conditioner protects against reverse-polarity connections, electrostatic discharge (ESD), undervoltage, overvoltage, and overcurrent.

WARNING: Both pairs of +VBATT and GROUND pins must be wired. Using a third-party power cable that wires only one (1) pair of +VBATT and GROUND pins may damage the power supply or the camera. Damage to the power supply or other components of the camera system caused by using an inappropriate power cable is not covered under warranty.

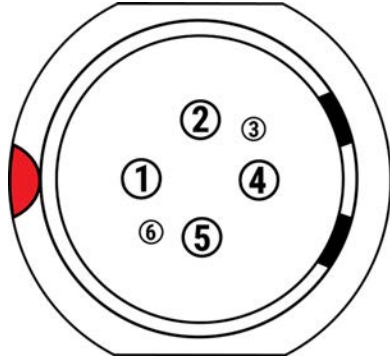

Figure: Front face of the male 6-Pin 1B DC power input connector (looking at the back of the camera).

6-PIN 1B DC INPUT CONNECTOR

PIN	SIGNAL	DESCRIPTION
1	+VBATT	Power input, +11.5 to +17 V DC
2	+VBATT	Power input, +11.5 to +17 V DC
3	SCL-BATT	Battery SMBus SCL signal (3.3 V)
4	GROUND	Power return (camera ground)
5	GROUND	Power return (camera ground)
6	SDA-BATT	Battery SMBus SDA signal (3.3 V)

NOTE: Mating connector is FGJ.1B.306.CWLD72Z.

COMPATIBLE CABLES

- **790-0638:** DSMC AC Power Adaptor Pack
- **790-0164:** XLR Power Cable (10')
- **790-0291:** DSMC Battery Belt Clip

B. MENU MAP

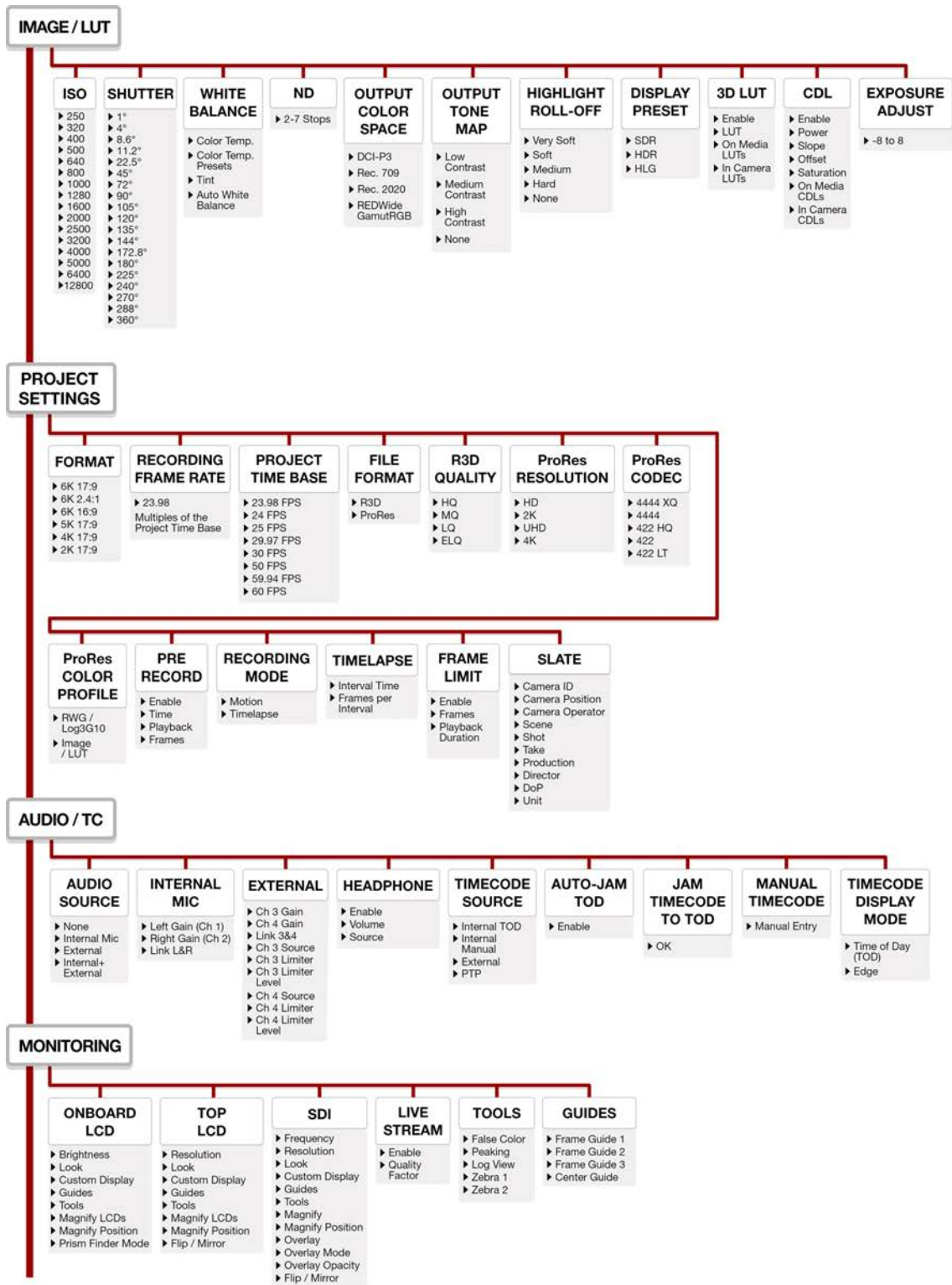

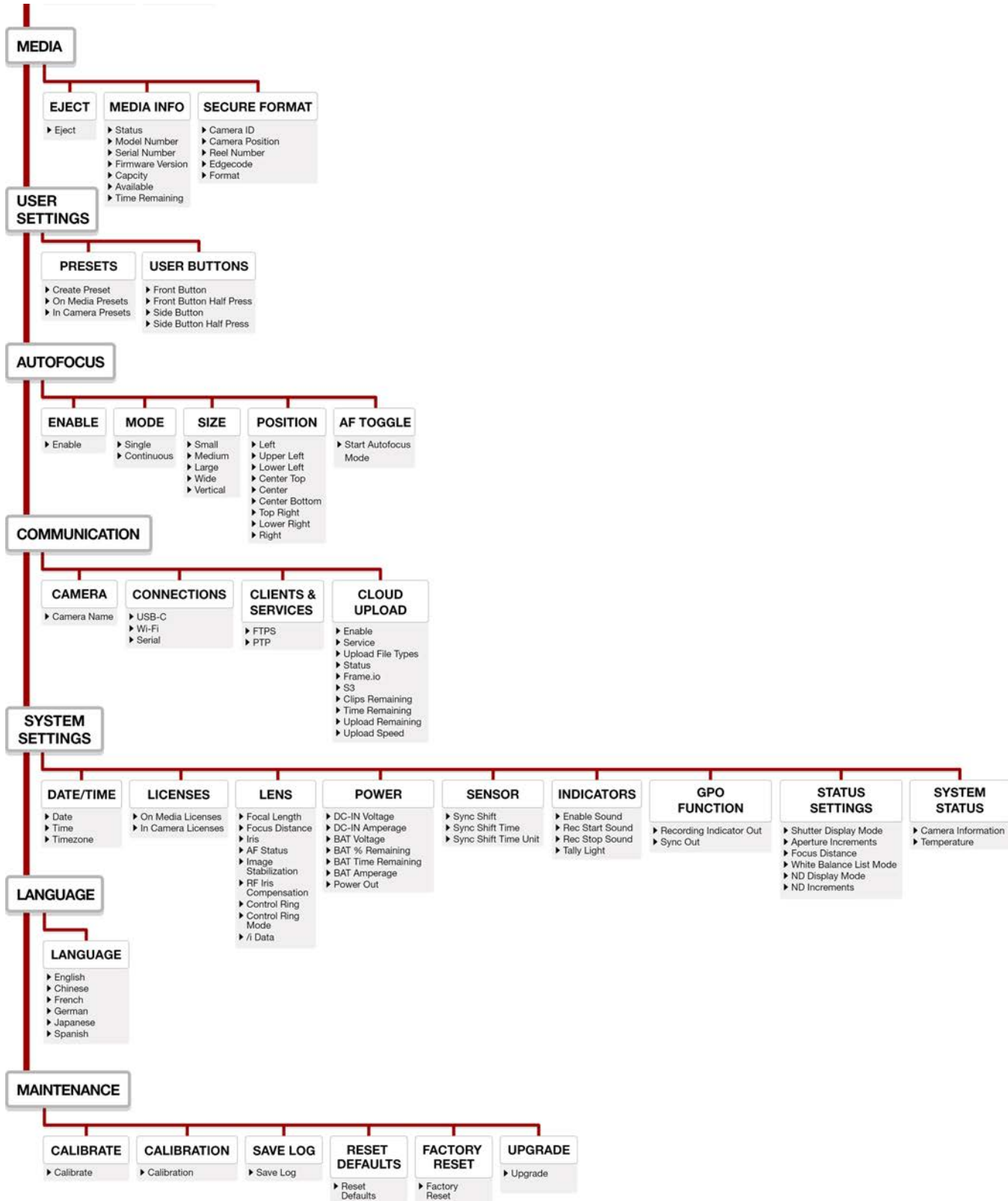

C. TECHNICAL SPECIFICATIONS

Technical specifications reflect both current and projected information. Everything is subject to change.

RED KOMODO-X™ CAMERA

SPECIFICATION	DESCRIPTION
Sensor Type	KOMODO-X™ 19.9 MP Super 35 mm Global Shutter CMOS
Effective Pixels	6144 x 3240
Sensor Size	27.03 mm x 14.26 mm (Diagonal: 30.56 mm)
Dynamic Range	16.5+ stops
Mount Type	Integrated locking RF mount with electronic communication Supports /i PL lenses with RED RF to PL Adapters Supports Canon EF adapter with communication and other adapters based on the RF mount
Max Data Rates	Up to 560 MB/s using RED branded or other qualified CFexpress media cards ¹
REDCODE [®] RAW Maximum Frame Rates	80 fps at 6K 17:9 (6144 x 3240) 96 fps at 5K 17:9 (5120 x 2700) 120 fps at 4K 17:9 (4096 x 2160) 240 fps at 2K 17:9 (2048 x 1080)
Playback Frame Rates (Project Time Base)	23.98, 24, 25, 29.97, 30, 50, 59.94, 60 fps, all resolutions
Best Available REDCODE [®] Settings	REDCODE HQ, MQ, LQ, and ELQ at 6K 17:9 (6144 x 3240) up to 80 fps REDCODE HQ, MQ, LQ, and ELQ at 4K 17:9 (4096 x 2160) up to 120 fps REDCODE HQ, MQ, LQ, and ELQ at 2K 17:9 (2048 x 1080) up to 240 fps
REDCODE [®] RAW Acquisition Formats	6K 17:9 (6144 x 3240), 2:1, 2.4:1, 16:9. 1:1, and Anamorphic 2x, 1.8x, 1.6x, 1.5x, 1.3x, 1.25x 5K 17:9 (5120 x 2700) and 16:9 4K 17:9 (4096 x 2160) and 16:9 2K 17:9 (2048 x 1080)
Apple [®] ProRes	Dedicated recording in 4K (4096 x 2160) ProRes 4444 XQ up to 60 fps, ProRes 4444 up to 80 fps, and ProRes 422 HQ, ProRes 422, and ProRes 422 LT up to 120 fps
Construction	Aluminum Alloy
Dimensions	L x W x H = 5.1 in x 4 in x 3.8 in (129.37 mm x 101.26 mm x 95.26 mm) largest fixed dimensions
Weight	2.62 lb (without body cap and CFexpress card)
Media Type	CFexpress Type B
Battery Type	Integrated V-Lock battery interface optimized for Micro V-Lock Batteries ¹
DC Power	11v-17v through a 6-pin DC-IN
Operating Temperature	0°C to 40°C (32°F to 104°F)
Storage Temperature	-20°C to 50°C (-4°F to 122°F)
Relative Humidity	0% to 85% non-condensing
Color Management	Image Processing Pipeline 2 (IPP2) Supports 33×33×33 3D LUTs Supports import and adjustment of CDLs

RED KOMODO-X™ CAMERA

SPECIFICATION	DESCRIPTION
Audio	Integrated dual channel digital mono microphones, uncompressed, 24-bit 48 kHz Integrated dual channel (mic/line/+48V) input through a 5-Pin 00B Audio Port, uncompressed, 24-bit 48 kHz 3.5 mm stereo headphone port
Autofocus	Phase Detect and Contrast
Monitor Options	Proprietary Top Accessory Port for Monitoring and Control Integrated 2.9" 1440 x 1440 touchscreen LCD with preview and camera control Integrated 12G-SDI with 6G-SDI, 3G-SDI and 1.5G-SDI modes 12G-SDI: Up to 4096 x 2160 4:2:2 for 60p 6G-SDI: Up to 4096 x 2160 4:2:2 for 30p 3G-SDI: Up to 2048 x 1080 4:2:2 for 60p 1.5G-SDI: Up to 2048 x 1080 4:2:2 for 30p, 24p SMPTE Timecode, HANC Metadata, 24-bit 48 kHz Audio
Additional I/O	Tri-Level Genlock Input through the 9-Pin EXT port LTC Timecode Input through the 9-Pin EXT port RS232 CTRL (using RCP2) through the 9-Pin EXT port
IP Connected	Wi-Fi (2.4 GHz / 5 GHz) for camera control, video preview, and media offloading Ethernet over USB Type-C for camera control, video preview, and media offloading MJPEG 1080p live stream accessible through Wi-Fi and USB-C PTP for frame level synchronization R3D live broadcasting available with RED Connect license and 5Gbps Ethernet adapter

SOFTWARE

RED Control App	Access full camera controls and live preview from iOS or Android devices
RED Control Pro App	Pro App: Operate one or multiple cameras over an IP connection to synchronize settings, manage media files locally or upload directly to FrameIO, develop custom looks with advanced CDL and LUT controls, and more Ideal for control of multi-camera arrays, multi-cam shoots, and live events, all from one central location Standard app available from the Apple App Store and Google Play Store RED Control Pro available via Apple App store only and requires additional purchase RED Control works wirelessly or wired over USB-C

1. For more information on approved mount adaptors, lenses, batteries, accessories and media cards, refer to [RED Third-Party Accessories](#)

D. ACCESSORIES

The following is a list of camera accessories. Some are optional, depending on the package you purchase:

- REDVOLT[®] NANO-V Battery
- REDVOLT[®] MICRO-V Battery
- RED[®] Compact Dual V-Lock Charger
- CFexpress Type B Media
- KOMODO-X[™] RF to PL Adapter Pack
- KOMODO-X[™] RF to PL with Electronic ND Adapter Pack
- DSMC3[™] RED[®] Touch 7.0" LCD
- DSMC3[™] RED[®] Touch 7.0" LCD Hood
- KOMODO-X[™] Power Adaptor
- Outrigger Handle
- RED[®] Compact Top Handle
- KOMODO[®] Wing Grip
- DSMC3[™] RED[®] 5-Pin to Single 3.5 mm Adapter
- DSMC3[™] RED[®] 5-Pin to Dual XLR Adapter
- RED[®] Pro I/O Module
- RED Control Apps
- RED Connect



REDVOLT[®] NANO-V BATTERY

The REDVOLT NANO-V battery is a small, lightweight power solution for the KOMODO-X. Weighing in at only 0.63 lb (288 g), it is ideal for gimbals, drones, and other setups where form factor and weight matter. The battery's dimensions (66 mm x 88 mm x 44 mm) ensure the camera retains completely flat surfaces on the top and sides, allowing users to attach various combinations of cages and plates, without issue.



Featuring a 49 Wh capacity and with a maximum output current of 6 amps, the battery can power the KOMODO-X and DSMC3[™] RED[®] Touch 7.0" LCD for short durations when you want to shoot in as light a configuration as possible.

ITEM	DETAILS
Type	Rechargeable Lithium-Ion Battery
Capacity	3300 mAh / 49 Wh
Battery output	12 to 16.8 V DC
Maximum load	6 Amps at 14 V DC
Operating temperature	50° F ~ 113° F (10° C ~ 45° C)
Charging temperature	32° F ~ 104° F (0° C ~ 40° C)
Storage temperature	68° F ~ 122° F (20° C ~ 50° C)
Charger	RED Compact Dual V-Lock charger
Weight	Approximately 0.63 lb (288 g)
Dimensions	Height: 3.46 in. (88 mm)
	Width: 2.60 in. (66 mm)
	Depth: 1.30 in. (44 mm)

REDVOLT NANO-V was designed in partnership with Core SWX and is compatible with most cameras/modules that accept V-Lock batteries. For issues or troubleshooting, please visit <https://coreswx.supportsystem.com>.

REDVOLT[®] MICRO-V BATTERY

The REDVOLT MICRO-V 14.7 Volt V-Lock battery includes an LED charge level indicator, a P-tap port, and a USB power port.



ITEM	DETAILS
Type	Rechargeable Lithium-Ion Battery
Capacity	6600 mAh / 98 Wh
Battery output	14.8 V DC
P-tap output	12 V DC
USB output	5 V DC (3 Amps)
Maximum load	12 Amps at 14 V DC
Operating temperature	50° F ~ 113° F (10° C ~ 45° C)
Charging temperature	32° F ~ 104° F (0° C ~ 40° C)
Storage temperature	68° F ~ 122° F (20° C ~ 50° C)
Charger	RED Compact Dual V-Lock charger
Weight	Approximately 1.2 lb (544.3 g)
Dimensions	Height: 3.93 in. (99.8 mm)
	Width: 2.82 in. (71.6 mm)
	Depth: 1.94 in. (49.3 mm)

COMPATIBLE BATTERIES

Compatible batteries are those that provide enough current (14.4 V with 6 A or greater) to power the RED KOMODO-X, and that also fit the dimensions on the KOMODO-X's integrated Micro V-Lock plate.

RED chose the Micro V-Lock for the KOMODO-X to keep its form-factor compact. As a result, not all V-Lock batteries are compatible with the camera.

NOTE:

- V-Lock batteries with a width greater than 2.95 in. (75 mm) are not compatible with the camera's Micro V-Lock plate and will require the battery adapter.
- The camera can charge a battery that supports SMBus communication directly. To charge the battery, the camera must be powered off while connected to DC-IN power. You can also use the optional RED Compact Dual V-Lock charger.

RED[®] COMPACT DUAL V-LOCK CHARGER

The optional RED Compact Dual V-Lock charger allows you to charge two REDVOLT batteries.



ITEM	DETAILS
Input	100 V - 240 V AC 50 Hz to 60 Hz
Charge current	One battery 3 Amps, two batteries 1.5 Amps
Charging temperature	32° F ~ 104° F (0° C ~ 40° C)
Storage temperature	68° F ~ 122° F (20° C ~ 50° C)
Battery compatibility	REDVOLT MICRO-V 14.7 V DC
Weight	Approximately 1 lb (453.5 g)
Dimensions	Height: 4.5 in. (114.3 mm)
	Width: 5.5 in. (139.7 mm)
	Depth: 3 in. (76.2 mm)

CFEXPRESS TYPE B MEDIA



The RED CFexpress Type B Media provides the camera with 660 gigabyte, 1, 1.3, 2, and 4 terabyte recording options. The 2 TB and 660 GB cards use the same hardware as do the 1.3 TB and 4 TB. The differences come from the software and firmware, which configure the media differently to prioritize different feature sets. The 1 TB, 2 TB and 4 TB prioritize capacity while still providing excellent durability under normal use. The 660 GB and 1.3 TB are in an overprovisioned configuration of the same media to prioritize extended write cycles and improved thermal performance for constant writing and re-writing of data. The underlying hardware is identical.

ITEM	DETAILS
Type	CFexpress Type B Media
Capacity - 660 GB High Endurance	660,138,909,696 bytes
Capacity - 1 TB High Capacity	1,099,511,627,776 bytes
Capacity - 1.3 TB High Endurance	1,331,512,536,141 bytes
Capacity - 2 TB High Capacity	2,048,480,824,832 bytes
Capacity - 4 TB High Capacity	4,096,961,649,664 bytes
Operating temperature	14° F to 158° F (-10° C to 70° C)
Operating humidity	5% to 95%, non-condensing
Storage temperature	-4° F to 185° F (-20° C to 85° C)
Shock resistance (operating)	50 g
Vibration resistance (operating)	15 g at 10 Hz to 2000 Hz
Weight	Approximately 0.25 oz (7.1 g)
Dimensions	Height: 1.52 in. (38.5 mm)
	Width: 1.17 in. (29.6 mm)
	Depth: 0.15 in. (3.8 mm)

RED[®] CFEXPRESS TYPE B READER

The RED CFexpress Type B Card Reader provides a fast USB-C connection with the capability of write-protect.

Set the Write-Protect switch to the Lock position to prevent connected devices from adding any unwanted data to your CFexpress Type B card.



ITEM	DETAILS
Media read	CFexpress Type B
Interface	USB-C 3.2 cable to CFexpress Type B
Power	USB bus power
Cable	USB-C 3.2 cable type A to C adapter
Weight	Approximately 4.2 oz (120 g)
Dimensions	Height: 3.74 in. (95 mm)
	Width: 2.56 in. (65 mm)
	Depth: 0.47 in. (12 mm)

KOMODO-X[™] RF TO PL ADAPTER PACK

The RED[®] KOMODO-X RF to PL Adapter Pack provides a robust PL mount solution for the RED KOMODO-X. Supporting Cooke /i lens communication, power and record triggering, the RF to PL Adapter expands the functionality of the camera's native RF lens mount for professional applications. Constructed of a titanium core, the shimmable RF to PL Adapter is resistant to environmental temperature changes, providing consistent and precise back focus.



The RED KOMODO-X RF to PL Adapter Pack includes both the KOMODO-X Side Ribs and Adapter Support Brackets to provide additional rigidity and a native-like mount experience.

NOTE: KOMODO-X RF to PL adapter is not compatible with Electronic Filters.

KOMODO-X[™] RF TO PL WITH ELECTRONIC ND ADAPTER PACK



The RED[®] KOMODO-X RF to PL with Electronic ND Adapter Pack includes two filters; A clear filter for when no ND is needed and an Electronic ND Filter with a 2-7 stop range. It features precise control of 1/4, 1/3 or full stop increments which allows choosing the exact exposure without compromising the intended aperture.

Each clear and electronic ND filters thickness are measured and paired together to ensure no back focus shifts when switching between filters.

ND can be controlled via the integrated buttons on the Electronic ND Filter, onboard LCD, DSMC3[™] RED[®] Touch 7.0" LCD, RED Control, RED Control Pro, web interface, or any other RCP2 compatible remote control, allowing for easy access to exposure no matter how the camera is configured.



Supporting Cooke /i lens communication and record triggering, the RF to PL Adapter w/ Electronic ND expands the functionality of the camera's native RF lens mount for professional applications. Constructed of a titanium core, the shimmable RF to PL Adapter is resistant to environmental temperature changes, providing consistent and precise back focus.

The RED KOMODO RF to PL Adapter w/ Electronic ND Filter Adapter Pack includes both the KOMODO[®] Side Ribs and Adapter Support Brackets to provide additional rigidity and a native-like mount experience.

COMPATIBILITY: Only compatible with KOMODO and KOMODO-X.

DSMC3™ RED[®] TOUCH 7.0" LCD



The optional DSMC3™ RED Touch 7.0" LCD offers an HD viewing experience for recording and viewing footage on the V-RAPTOR™ XL camera. A 1920 x 1200 resolution display panel with peak brightness of 1300 nits and high pixel density (at 322 ppi), not only provides the optimal experience when viewing footage, but also features 100% DCI-P3 color gamut coverage for tremendous color accuracy.

This monitor also features full control over the camera through the new responsive menu system powered by SmallHD PageOS. The features include Waveform, Vectorscope, Histogram, False Color, Color Picker, Pixel Zoom, and more.

The lightweight display mounts to a removable integrated tilt arm with the capability to rotate 180 degrees for versatile mounting options.

It also boasts the latest generation pogo pins to provide power and video to the monitor, and the ability to connect through a single-locking USB-C-style DSMC3™ RMI cable for video and power. No additional SDI or power cables are needed.

Refer to [RED Monitor Interface Cable](#) for more information.

NOTE: The USB-C-style DSMC3™ RMI cable is not a standard USB-C cable. The DSMC3™ RED Touch 7.0" LCD is not compatible with DSMC[®], DSMC2[®], RED RANGER[®] or KOMODO[®] camera systems.

For more information, refer to the [DSMC3™ RED[®] Touch 7.0" LCD User Guide](#).

SPECIFICATIONS

ITEM	DETAILS
Material	Aluminum alloy
Resolution	1920 x 1200
Pixel density	322 ppi
Refresh rate	60 Hz
Response time	25 ms
Contrast	1250:1
Brightness	1300 cd/m ²
Color depth	10-bit (8-bit panel)

ITEM	DETAILS
Colors	100% DCI-P3
Viewing angle	± 160° all axes
Display orientation	Landscape, 180° rotation
Touch	pCap Multi-Touch
Camera connection	Power and communication through the RMI cable
Mounting	15 mm rail
Hood Mounting	4 x M3 mounting points
Buttons	4 buttons function 1, 2, 3 & 4
EXP Ports	For future use, not currently supported
Power consumption	15.5 Watts
Operating temperature	32° F to 104° F (0° C to 38° C)
Storage temperature	-0° F to 120° F (-18° C to 49° C)
Operating humidity	0% to 85%, non-condensing
Storage humidity	0% to 85%, non-condensing
Firmware requirement	Compatible with V-RAPTOR firmware version 1.1 or later
Monitor dimensions	Weight approximately 1.25 lb (568.0 g) Height: 4.67 in. (118.70 mm) Width: 7.09 in. (180.10 mm) Depth: 1.13 in. (28.80 mm)
Arm dimensions	Weight approximately 0.07 lb (30.1 g) Height: 1.18 in. (30.00 mm) Width: 2.40 in. (61.00 mm) Depth: 0.70 in. (17.50 mm)
RED Monitor Interface (RMI) dimensions	Weight approximately 0.28 lb (126 g) Height: 1.67 in. (42.50 mm) Width: 4.25 in. (108.00 mm) Depth: 1.51 in. (38.23 mm)

DSMC3™ RED® TOUCH 7.0" LCD HOOD



The DSMC3™ RED® Touch 7.0" LCD Hood attaches easily and directly to the DSMC3™ RED® Touch 7.0" LCD and can block out the sun to make viewing the LCD easier in bright conditions.

COMPATIBILITY: The DSMC3™ RED® Touch 7.0" LCD Hood is only compatible with the DSMC3™ RED® Touch 7.0" LCD.

KOMODO-X[™] POWER ADAPTOR



The KOMODO-X 150-Watt AC power adaptor connects to the camera's port to provide DC power for operating the camera and for recharging the attached **REDVOLT[®] MICRO-V Battery**.

The camera charges the battery when the camera is off and the power adaptor is connected.

OUTRIGGER HANDLE

The Outrigger Handle offers a low profile, 360° adjustable ergonomic pistol grip and integrated Record Start/Stop button. Mounted to the Top Handle Port on your camera, the Outrigger Handle provides comfort, stability, and additional 1/4-20 mounting points for your peripheral camera components. The built-in Record button puts Start/Stop functionality right at your fingertips. You are always ready to capture the perfect shot.



The Outrigger Handle is ideal for shooters who use one hand on the handle for grip and record button access, and the other for lens adjustments or support.

RED[®] COMPACT TOP HANDLE

The RED[®] Compact Top Handle easily mounts to the top of the KOMODO, KOMODO-X or V-RAPTOR camera bodies while offering a combination of comfort and utility for carrying or shooting with your camera.



This top-mounted machined handle features ergonomic Bocote wood inlays with camera trigger control.

The handle includes:

- Handle trigger
- Rear 3" piece
- Front 1" piece
- 15 mm monitor mount

For issues or troubleshooting, contact support@cs.inc.

COMPATIBILITY: The RED Compact Top Handle is not compatible with DSMC[®], DSMC2[®] or RED RANGER[®] camera systems.

INSTALLING THE DSMC3[™] RED[®] TOUCH 7.0" LCD ON THE TOP HANDLE

To install the RED Touch LCD to the Top Handle:

1. Align a Top Handle Extension with front of the Top Handle.
2. Tighten the hex bolt to the Top Handle.
3. Align the 15 mm Monitor Mount extension bolt with the side 3/8-16 mount hole of the Top Handle extension.
4. Tighten the Monitor Mount bolt to the Top Handle extension.
5. Align the 15 mm hole on the Monitor rail to the 15 mm Monitor Mount.
6. Slip the 15 mm Monitor rail collar over the 15 mm Monitor mount post and tighten the knurled knob on the Monitor rail to the desired monitor position.

KOMODO[®] WING GRIP

The KOMODO Wing Grip offers comfort and utility for carrying or shooting with your KOMODO-X.



Featuring an ergonomic machined grip with tactical 1/4-20 mounting points. It is lightweight and offers a seamless low-profile hand-held option.

The KOMODO Wing Grip is a simple handle and that provides extra mounting options for your camera.

DSMC3[™] RED[®] 5-PIN TO SINGLE 3.5 MM ADAPTER



The DSMC3[™] RED[®] 5-Pin to Single 3.5 mm Adapter is a 11.3" (28.9 cm) cable designed to break out the 5-Pin Audio port to a single 3.5 mm TRS input allowing for 3.5 mm audio devices to be connected.

NOTES:

Length measured from end to end including connectors.

For replacement or additional components, such as screws, contact

support@cs.inc.

COMPATIBILITY: The DSMC3[™] RED 5-Pin to Single 3.5 mm Adapter is not compatible with DSMC[®], DSMC2[®], RED RANGER[®] or KOMODO[®] camera systems.

DSMC3[™] RED[®] 5-PIN TO DUAL XLR ADAPTER



The DSMC3[™] RED[®] 5-Pin to Dual XLR Adapter is a compact solution for breaking out the 5-Pin Audio port to dual 3-Pin XLR ports. This adapter provides two industry standard XLR ports providing 48-volt phantom power, and mic and line input that is easily mounted to your camera.

The Dual XLR adapter's modular design provides several mounting options for the camera.

The Dual XLR adapter includes the following:

- Dual XLR adapter
- L-shaped mounting bracket with 2 x 3/16 screws and 4 x Anti-Rotate pins
- A replacement 1/4-20 mounting screw
- 18" Right angle-to-straight 5-Pin cable

To attach the L-shaped mounting bracket:

1. Determine the mounting position on or off of the camera. You may need to re-position or remove the anti-rotate pins on the bracket depending on the orientation and position you want to mount the bracket. You can also mount the bracket to the camera by using the replacement 1/4-20 screw.
2. Screw one of the 3/16 screws in the Dual XLR adapter ensuring the anti-rotate pins line up with the desired position of the Dual XLR adapter. Then attach the other side of the bracket to the position of your choice, confirming that the anti-rotate pins align with holes on the camera.

NOTE: Make sure that you only pull on the knurled sleeve of the 90° angle connector on the 18" Right angle-to-straight 5-Pin cable when removing it from the Dual XLR adapter.

RED[®] PRO I/O MODULE

The RED[®] Pro I/O Module offers a variety of input/ output connections, and it also includes an industry standard V-Lock or Gold mount to power your KOMODO-X™ with higher capacity batteries. This module mounts directly to the KOMODO-X's rear Micro V-Lock plate and 9-Pin EXT Port, and it offers connections for the following:

- DC Power Input (DC-IN)
- Genlock (BNC)
- CTRL (4-Pin)
- Timecode (5-pin)
- 1 x 3-Pin 24-volt (regulated) Fischer R/S port (3 A max)
- 2 x 2-Pin 12-volt (unregulated) AUX ports (3 A combined max)

The module also includes an operator-side screen which displays key power voltage and battery percentage information (with compatible batteries) along with a power switch to cut power to the module when you want to leave a battery on the module for long durations.

NOTE: The RED Pro V-Lock I/O Module is only compatible with KOMODO-X™. It is recommended to use 12 A Batteries such as the REDVOLT[®] MICRO-V or REDVOLT[®] XL-V when using all AUX outputs simultaneously. When used with REDVOLT[®] NANO-V the AUX power outputs will be disabled.



The RED[®] Pro I/O Module connects to the camera through the KOMODO-X [Extension Port](#).

CONNECTOR	CONNECTOR TYPE	DETAILS
24V RS	3-pin Fischer	24-volt (regulated) Fischer R/S port (3 A max)
Timecode	5-pin	Connection for external Timecode device
CTRL	4-pin 00B ODU	CTRL (RS-232 Control) port for external RS-232 connection
Genlock	BNC	Connection for external Genlock device
Module cable	9-pin 0B ODU	Attaches to the Extension Port
DC-IN	6-pin 1B socket	Connection for external DC power

RED CONTROL APPS

The RED Control apps provides remote and tethered access to the camera from a device. Access is available through Wi-Fi, USB-C, and Ethernet.

RED CONTROL

The RED Control app is free through the Google Play store and the Apple App store.

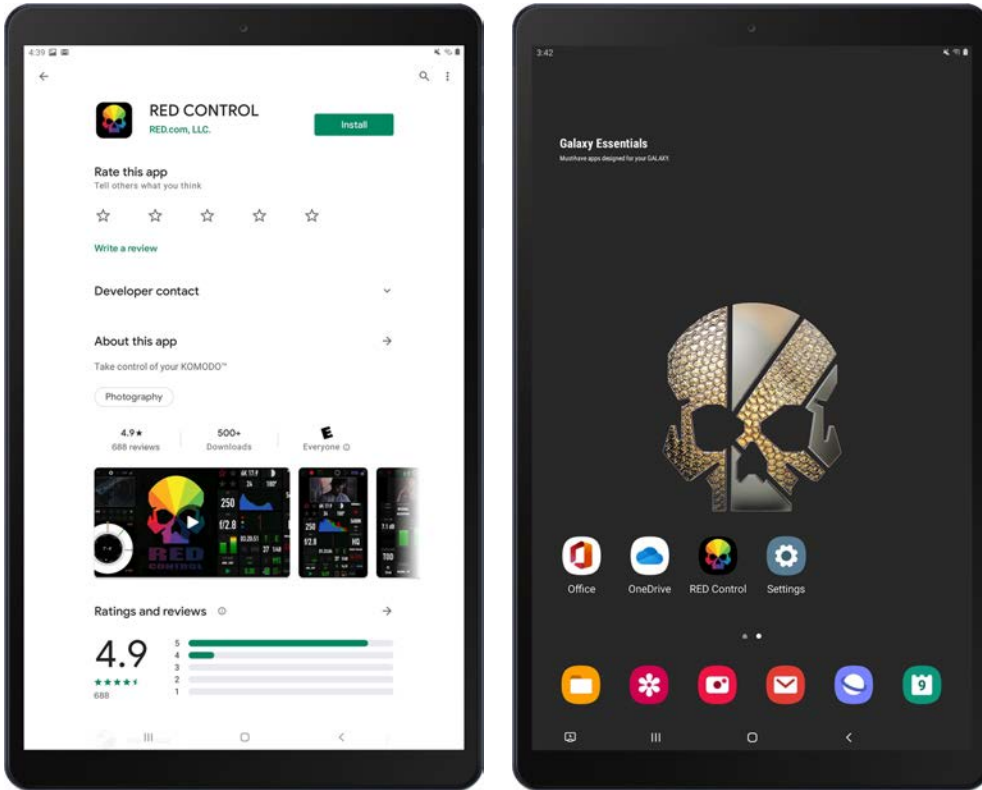

The RED Control app allows you to control all of the KOMODO features while viewing the image.

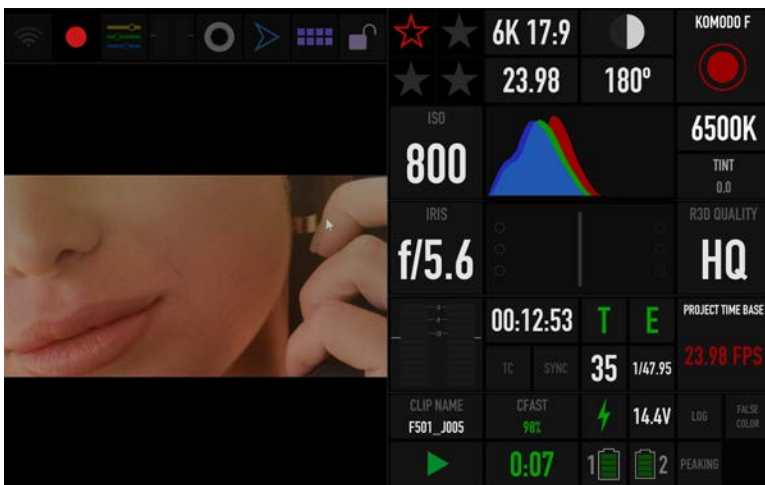

For more information about connecting the camera to RED Control, refer to the How To section ([USB-C Configuration](#)).

RED CONTROL PRO

RED Control Professional allows you to control multiple RED DSMC3 cameras from an Apple iPad or an Apple Mac. RED Control Pro is a licensed application available from the [Apple App Store](#).



RED CONNECT

RED Connect is a license enabled features available on either KOMODO-X, V-RAPTOR, or V-RAPTOR XL, which streams full resolution live R3D video over an IP network by simply connecting the camera control unit (CCU) with an Ethernet cable for KOMODO-X or with the RED Connect Module for V-RAPTOR and V-RAPTOR XL. This new feature opens up an extraordinary range of creative applications from live broadcast to virtual production and true 8K VR (V-RAPTOR, V-RAPTOR XL).

RED Connect Licenses are available with options for one year or perpetual.

For more information, refer to <https://www.red.com/red-connect>.